

Annual Report of the Board of Regents

of the

SMITHSONIAN

INSTITUTION



PUBLICATION 4314

Showing the Operations, Expenditures, and Condition of the

Institution for the Year Ended June 30

1957

UNITED STATES

GOVERNMENT PRINTING OFFICE

WASHINGTON : 1958

Q
11
S66X
CRLSS1

LETTER OF TRANSMITTAL

SMITHSONIAN INSTITUTION,
Washington, December 31, 1957.

To the Congress of the United States:

In accordance with section 5593 of the Revised Statutes of the United States, I have the honor, on behalf of the Board of Regents, to submit to Congress the annual report of the operations, expenditures, and condition of the Smithsonian Institution for the year ended June 30, 1957. I have the honor to be,

Respectfully,

LEONARD CARMICHAEL, *Secretary.*

ii

CONTENTS

| | Page |
|--|------|
| List of officials..... | v |
| General statement..... | 1 |
| The Establishment..... | 4 |
| The Board of Regents..... | 4 |
| Finances..... | 5 |
| Visitors..... | 6 |
| Lectures..... | 6 |
| Bio-Sciences Information Exchange..... | 7 |
| Summary of the year's activities of the Institution..... | 7 |
| Reports of branches of the Institution: | |
| United States National Museum..... | 11 |
| Bureau of American Ethnology..... | 40 |
| Astrophysical Observatory..... | 68 |
| National Collection of Fine Arts..... | 82 |
| Freer Gallery of Art..... | 98 |
| National Air Museum..... | 111 |
| National Zoological Park..... | 125 |
| Canal Zone Biological Area..... | 155 |
| International Exchange Service..... | 163 |
| National Gallery of Art..... | 172 |
| Report on the library..... | 185 |
| Report on publications..... | 189 |
| Report of the executive committee of the Board of Regents..... | 196 |

GENERAL APPENDIX

| | |
|---|-----|
| Science, technology, and society, by L. R. Hafstad..... | 207 |
| United States Coast and Geodetic Survey, 1807-1957, by Elliott B. Roberts..... | 221 |
| Cosmic rays from the sun, by Thomas Gold..... | 233 |
| Meteors, by Fred L. Whipple..... | 239 |
| The development of the planetarium in the United States, by Joseph Miles Chamberlain..... | 261 |
| The development of radio astronomy, by Gerald S. Hawkins..... | 279 |
| Jet streams, by R. Lee..... | 293 |
| Pollen and spores and their use in geology, by Estella B. Leopold and Richard A. Scott..... | 303 |
| The influence of man on soil fertility, by G. V. Jacks..... | 325 |
| The land and people of the Guajira Peninsula, by Raymond E. Crist..... | 339 |
| The nature of viruses, cancer, genes, and life, by Wendell M. Stanley..... | 357 |
| Mystery of the red tide, by F. G. Walton Smith..... | 371 |
| The return of the vanishing musk oxen, by Hartley H. T. Jackson..... | 381 |

| | Page |
|--|------|
| Bamboo in the economy of Oriental peoples, by F. A. McClure..... | 391 |
| Mechanizing the cotton harvest, by James H. Street..... | 413 |
| Aniline dyes—their impact on biology and medicine, by Morris C. Leikind.. | 429 |
| Causes and consequences of salt consumption, by Hans Kaunitz..... | 445 |
| Roman garland sarcophagi from the quarries of Proconnesus (Marmara), by J. B. Ward Perkins..... | 455 |
| Stone age skull surgery, by T. D. Stewart..... | 469 |

LIST OF PLATES

Secretary's Report:

| | |
|--|-----|
| Plates 1, 2..... | 54 |
| Plates 3, 4..... | 102 |
| Plates 5, 6, 7..... | 150 |
| Plates 8, 9..... | 182 |
| United States Coast and Geodetic Survey (Roberts): Plates 1-5..... | 230 |
| Cosmic rays (Gold): Plate 1..... | 238 |
| Meteors (Whipple): Plates 1-6..... | 246 |
| Planetarium (Chamberlain): Plates 1-6..... | 278 |
| Radio astronomy (Hawkins): Plates 1, 2..... | 286 |
| Jet streams (Lee): Plate 1..... | 294 |
| Guajira Peninsula (Crist): Plates 1-10..... | 342 |
| Red tide (Smith): Plates 1-4..... | 374 |
| Musk oxen (Jackson): Plates 1, 2..... | 390 |
| Bamboo (McClure): Plates 1-10..... | 406 |
| Cotton harvest (Street): Plates 1, 2..... | 422 |
| Sarcophagi (Ward Perkins): Plates 1-6..... | 462 |
| Skull surgery (Stewart): Plates 1-10..... | 486 |

THE SMITHSONIAN INSTITUTION

June 30, 1957

Presiding Officer ex officio.—DWIGHT D. EISENHOWER, President of the United States.

Chancellor.—EARL WARREN, Chief Justice of the United States.

Members of the Institution:

DWIGHT D. EISENHOWER, President of the United States.

RICHARD M. NIXON, Vice President of the United States.

EARL WARREN, Chief Justice of the United States.

JOHN FOSTER DULLES, Secretary of State.

GEORGE M. HUMPHREY, Secretary of the Treasury.

CHARLES E. WILSON, Secretary of Defense.

HERBERT BROWNELL, JR., Attorney General.

ARTHUR E. SUMMERFIELD, Postmaster General.

FRED A. SEATON, Secretary of the Interior.

EZRA TAFT BENSON, Secretary of Agriculture.

SINCLAIR WEEKS, Secretary of Commerce.

JAMES P. MITCHELL, Secretary of Labor.

MARION B. FOLSOM, Secretary of Health, Education, and Welfare.

Regents of the Institution:

EARL WARREN, Chief Justice of the United States, Chancellor.

RICHARD M. NIXON, Vice President of the United States.

CLINTON P. ANDERSON, Member of the Senate.

LEVERETT SALTONSTALL, Member of the Senate.

H. ALEXANDER SMITH, Member of the Senate.

OVERTON BROOKS, Member of the House of Representatives.

CLARENCE CANNON, Member of the House of Representatives.

JOHN M. VOYBS, Member of the House of Representatives.

JOHN NICHOLAS BROWN, citizen of Rhode Island.

ARTHUR H. COMPTON, citizen of Missouri.

ROBERT V. FLEMING, citizen of Washington, D. C.

CRAWFORD H. GREENEWALT, citizen of Delaware.

CARYL P. HASKINS, citizen of Washington, D. C.

JEROME C. HUNSAKER, citizen of Massachusetts.

Executive Committee.—ROBERT V. FLEMING, *chairman*, CLARENCE CANNON, CARYL P. HASKINS.

Secretary.—LEONARD CARMICHAEL.

Assistant Secretaries.—J. E. GRAF, J. L. KEDDY.

Administrative assistant to the Secretary.—MRS. LOUISE M. PEARSON.

Treasurer.—T. F. CLARK.

Chief, editorial and publications division.—PAUL H. OEHSER.

Librarian.—MRS. LEILA F. CLARK.

Superintendent of buildings and grounds.—L. L. OLIVER.

Chief, personnel division.—J. B. NEWMAN.

Chief, supply division.—A. W. WILDING.

Chief, photographic laboratory.—F. B. KESTNER.

UNITED STATES NATIONAL MUSEUM

Director.—A. REMINGTON KELLOGG.

Assistant Director.—F. A. TAYLOR.

Planning Officer.—J. C. EWERS.

Administrative assistant.—W. E. BOYLE.

Chief exhibits specialist.—J. E. ANGLIM.

Chief zoological exhibits specialist.—W. L. BROWN.

Registrar.—HELENA M. WEISS.

DEPARTMENT OF ANTHROPOLOGY: F. M. Setzler, head curator.

Division of Archeology: W. R. Wedel, curator; Clifford Evans, Jr., associate curator.

Division of Ethnology: H. W. Krieger, curator; S. H. Riesenbergs, C. M. Watkins, associate curators; R. A. Elder, Jr., G. C. Lindsay, Rodris C. Roth, assistant curators.

Division of Physical Anthropology: T. D. Stewart, curator; M. T. Newman, associate curator.

DEPARTMENT OF ZOOLOGY: W. L. Schmitt, head curator.

Division of Mammals: D. H. Johnson, curator; H. W. Setzer, C. O. Handley, Jr., associate curators.

Division of Birds: Herbert Friedmann, curator; H. G. Deignan, associate curator.

Division of Reptiles and Amphibians: Doris M. Cochran, curator.

Division of Fishes: L. P. Schultz, curator; E. A. Lachner, W. R. Taylor, associate curators.

Division of Insects: J. F. G. Clarke, curator; O. L. Cartwright, R. E. Crabill, W. D. Field, Grace E. Glance, associate curators; Sophy Parfin, junior entomologist.

Division of Marine Invertebrates: F. A. Chace, Jr., curator; F. M. Bayer, T. E. Bowman, C. E. Cutress, Jr., associate curators.

Division of Mollusks: H. A. Rehder, curator; J. P. E. Morrison, associate curator.

DEPARTMENT OF BOTANY (NATIONAL HERBARIUM): J. R. Swallen, head curator.

Division of Phanerogams: L. B. Smith, curator; R. S. Cowan, E. C. Leonard, Velva E. Rudd, E. H. Walker, associate curators.

Division of Ferns: C. V. Morton, curator.

Division of Grasses: J. R. Swallen, curator.

Division of Cryptogams: C. V. Morton, acting curator; P. S. Conger, M. E. Hale, Jr., associate curators.

DEPARTMENT OF GEOLOGY: G. A. Cooper, head curator; J. H. Benn, museum geologist.

Division of Mineralogy and Petrology: G. S. Switzer, acting curator; E. P. Henderson, associate curator.

Division of Invertebrate Paleontology and Paleobotany: G. A. Cooper, curator; P. M. Kier, David Nicol, associate curators.

Division of Vertebrate Paleontology: C. L. Gazin, curator; D. H. Dunkle, associate curator.

DEPARTMENT OF ENGINEERING AND INDUSTRIES: R. P. Multhaupt, head curator.

Division of Engineering: R. S. Woodbury, curator.

Section of Mechanical and Civil Engineering: R. S. Woodbury, in charge.

Section of Tools: R. S. Woodbury, in charge.

Section of Light Machinery: A. E. Battison, associate curator.

DEPARTMENT OF ENGINEERING AND INDUSTRIES—Continued

Division of Engineering—Continued

Section of Marine Transportation: K. M. Perry, associate curator.

Section of Electricity: W. J. King, associate curator.

Section of Land Transportation: R. S. Woodbury, in charge.

Section of Physical Sciences and Measurement: R. P. Multhauf, in charge.

Division of Crafts and Industries: W. N. Watkins, curator.

Section of Textiles: Grace L. Rogers, associate curator.

Section of Wood Technology: W. N. Watkins, in charge.

Section of Agricultural Industries: E. C. Kendall, associate curator.

Division of Industrial Cooperation: P. W. Bishop, curator.*Division of Medicine and Public Health*: G. B. Griffenhagen, curator.*Division of Graphic Arts*: Jacob Kainen, curator.

Section of Photography: A. J. Wedderburn, Jr., associate curator.

DEPARTMENT OF HISTORY: M. L. Peterson, acting head curator.

Division of Military History: E. M. Howell, acting curator; Craddock R. Goins, J. R. Sirlouis, assistant curators.*Division of Naval History*: M. L. Peterson, curator.*Division of Civil History*: Mrs. Margaret W. Brown Klapthor, associate curator; C. G. Dorman, Mrs. Anne W. Murray, assistant curators.*Division of Numismatics*: Vladimir Clain-Stefanelli, curator.*Division of Philately*: F. R. Bruns, Jr., curator; F. J. McCall, assistant curator.

BUREAU OF AMERICAN ETHNOLOGY

Director.—M. W. STIRLING.*Associate Director*.—F. H. H. ROBERTS, Jr.*Anthropologist*.—H. B. COLLINS, Jr.*Ethnologist*.—W. C. STURTEVANT.RIVER BASIN SURVEYS.—F. H. H. ROBERTS, Jr., *Director*.

ASTROPHYSICAL OBSERVATORY

Director.—F. L. WHIPPLE.*Associate Directors*.—J. A. HYNEK, T. E. STERNE.*Assistant Director*.—J. S. RINEHART.*Astrophysicists*.—E. L. FIREMAN, L. G. JACCHIA, C. A. WHITNEY, F. B. RIGGS, Jr., M. KROOK.*Mathematician*.—R. E. BRIGGS.*Physicist*.—A. S. MELTZER.*Table Mountain, Calif., field station*.—A. G. FROILAND, *Physicist*.

DIVISION OF RADIATION AND ORGANISMS:

Chief.—R. B. WITHROW.*Plant physiologists*.—W. H. KLEIN, Mrs. ALICE P. WITHROW, LEONARD PRICE, V. B. ELSTAD, C. C. MOH.*Biochemist*.—J. B. WOLFF.

NATIONAL COLLECTION OF FINE ARTS

Director.—T. M. BEGGS.*Curator of ceramics*.—P. V. GARDNER.*Chief, Smithsonian Traveling Exhibition Service*.—Mrs. ANNEMARIE H. POPE.

FREER GALLERY OF ART

Director.—A. G. WENLEY.

Assistant Director.—J. A. POPE.

Acting assistant to the Director.—RAYMOND A. SCHWARTZ.

Associate in Near Eastern art.—RICHARD ETTINGHAUSEN.

Associate in technical research.—R. J. GETTENS.

Assistant in research.—H. P. STERN.

NATIONAL AIR MUSEUM

Advisory Board:

LEONARD CARMICHAEL, *Chairman.*

Maj. Gen. REUBEN C. HOOD, JR., *U. S. Air Force.*

Rear Adm. JAMES S. RUSSELL, *U. S. Navy.*

Lt. Gen. JAMES H. DOOLITTLE.

GROVER LOENING.

Head curator.—P. E. GARBER.

Associate curator.—W. M. MALE.

NATIONAL ZOOLOGICAL PARK

Acting Director.—T. H. REED.

Assistant Director.—J. L. GRIMMER.

CANAL ZONE BIOLOGICAL AREA

Resident Naturalist.—C. B. KOFORD.

INTERNATIONAL EXCHANGE SERVICE

Chief.—D. G. WILLIAMS.

NATIONAL GALLERY OF ART

Trustees:

EARL WARREN, Chief Justice of the United States, *Chairman.*

JOHN FOSTER DULLES, Secretary of State.

GEORGE M. HUMPHREY, Secretary of the Treasury.

LEONARD CARMICHAEL, Secretary of the Smithsonian Institution.

F. LAMMOT BELIN.

DUNCAN PHILLIPS.

CHESTER DALE.

PAUL MELLON.

RUSH H. KRESS.

President.—CHESTER DALE.

Vice President.—F. LAMMOT BELIN.

Secretary-Treasurer.—HUNTINGTON CAIRNS.

Director.—JOHN WALKER.

Administrator.—ERNEST R. FEIDLER.

General Counsel.—HUNTINGTON CAIRNS.

Chief Curator.—PERRY B. COTT.

Assistant Director.—MACGILL JAMES.

Honorary Research Associates, Collaborators, and Fellows

Anthropology

Mrs. Arthur M. Greenwood
N. M. Judd
T. W. McKern

Betty J. Meggers
W. W. Taylor, Jr.
W. J. Tobin

Zoology

Paul Bartsch, Mollusks
J. Bruce Bredin
L. L. Buchanan, Coleoptera
M. A. Carriker, Insects
C. J. Drake, Insects
D. C. Graham, Biology
Horton H. Hobbs, Jr., Marine Invertebrates
A. B. Howell, Mammals
W. L. Jellison, Insects
W. M. Mann, Hymenoptera

Allen McIntosh, Mollusks
J. P. Moore, Marine Invertebrates
C. F. W. Muesebeck, Insects
Benjamin Schwartz, Helminthology
Mrs. Harriet Richardson Searle, Marine Invertebrates
C. R. Shoemaker
R. E. Snodgrass, Insects
Alexander Wetmore, Birds
Mrs. Mildred S. Wilson, Copepod Crustacea

Botany

Mrs. Agnes Chase, Grasses
E. P. Killip, Phanerogams

F. A. McClure, Grasses
J. A. Stevenson, Fungi

Geology

R. S. Bassler, Paleontology
R. W. Brown, Paleobotany
Preston Cloud, Invertebrate Paleontology
C. Wythe Cooke, Invertebrate Paleontology

J. B. Knight, Invertebrate Paleontology
Mrs. Helen N. Loeblich, Invertebrate Paleontology
J. B. Reeside, Jr., Invertebrate Paleontology
W. T. Schaller, Mineralogy

Engineering and Industries

F. L. Lewton, Crafts and Industries

History

Elmer C. Herber
F. W. MacKay, Numismatics

Carroll Quigley
P. A. Straub, Numismatics

National Zoological Park

W. M. Mann

E. P. Walker

Bureau of American Ethnology

J. P. Harrington
R. F. Heizer
Sister M. Inez Hilger
R. S. Solecki

R. J. Squier
J. R. Swanton
A. J. Waring, Jr.

Astrophysical Observatory

C. G. Abbot

Freer Gallery of Art

Grace Dunham Guest
Max Loehr

| Katherine N. Rhoades

Canal Zone Biological Area

C. C. Soper

| James Zetek

Report of the Secretary of the Smithsonian Institution

LEONARD CARMICHAEL

For the Year Ended June 30, 1957

To the Board of Regents of the Smithsonian Institution:

GENTLEMEN: I have the honor to submit a report showing the activities and condition of the Smithsonian Institution and its branches for the fiscal year ended June 30, 1957.

GENERAL STATEMENT

The one-hundred-and-eleventh year of the Smithsonian Institution has been marked by progress in many areas. James Smithson in his will that established the Institution provided that it should be concerned with both the *increase* and the *diffusion* of knowledge among men. During the year covered by this report, as in previous years, the institution has been active and successful in research, that is, in the increase of knowledge. It has also continued to carry on the diffusion of knowledge by publications, lectures, correspondence, and above all by museum displays.

Details of the research activities, publications, and other work of the institution are given in later pages. In introducing the report, it seems particularly fitting this year to make special reference to the museum functions of the Smithsonian. Public exhibitions are not part of the assigned functions of all Smithsonian bureaus. The following units, however, do maintain such exhibits: The United States National Museum, the National Collection of Fine Arts, the Freer Gallery of Art, the National Air Museum, the National Zoological Park, and the National Gallery of Art. As a group these Smithsonian units care for the great national collections of the United States. Collectively, in number and quality of objects, these units as part of the "Smithsonian Museum Complex" constitute one of the largest and most distinguished groups of cultural and scientific collections in the world. All these parts of the Smithsonian are alike in that they are concerned with the preservation, maintenance and restoration, study, and appropriate public display of their collections. The National Gallery of Art and the Freer Gallery of Art were built and given to the Nation by Andrew W. Mellon and Charles Lang

Freer, respectively. Both of these galleries admirably provide for the specialized work of preservation, restoration, study, and public display of their great art treasures.

The United States National Museum, the National Collection of Fine Arts, the National Air Museum, and the National Zoological Park all in different ways need added facilities in order to perform the functions assigned to them in a manner that is fitting for the collections of the United States of America.

Much progress has been made during the year in the work of the United States National Museum. Detailed, and in some respects definitive, planning has been carried on for the new and additional building for this museum for which a Federal appropriation was made last year. This building, to be known as the Museum of History and Technology, will be located on the Mall on a plot of land bounded on the north, east, and west, respectively, by Constitution Avenue, Twelfth Street, and Fourteenth Street. When completed, this new structure, housing the Nation's collections in the fields of history and technology, will be one of the world's finest museum buildings. It will do much to regain for the United States its proper place in the museum world which this country has been gradually losing during the past half century. The years since the end of the Second World War have seen a sharp increase in national museum construction and reconstruction throughout the world.

The Natural History Building of the United States National Museum is also almost desperately overcrowded. A quarter of a century ago this condition was recognized by the Congress, and new wings for this building were authorized. The detailed planning of these wings and their construction thus constitute one of the great current needs of the Smithsonian, and funds for such planning are included in the 1958 Smithsonian appropriation.

Besides planning for new buildings and additions to existing buildings, the Smithsonian was active during this year in the reconditioning and renovation of its buildings. Some of the old buildings of the Institution had fallen into real disrepair. This year wooden sash of the Smithsonian Building was renewed, external painting carried on, and much needed repairs to the plumbing, electrical and heating service were made in this and other buildings.

The program of modernizing the public displays of the Institution explained in previous reports was continued this year. Notable new halls showing life in early America, power machinery, mammals of North America, and the history of the telephone were opened. The interest created by these new and truly educational halls is reflected in a large increase in attendance.

The staff of the National Collection of Fine Arts improved details of the exhibits of this important unit in our Nation's provision for the preservation, study, and display of works of art. It becomes more certain each year, however, that the really great collection of American paintings and the decorative arts which is served by this bureau can never be adequately dealt with until it has a satisfactory building of its own. Its present borrowed space in the Natural History Building is both inadequate and inappropriate. The greatest paintings of American artists and examples of outstanding Renaissance jewelry should not be displayed next door to dinosaur bones and totem poles.

The National Air Museum has also added many significant items to its great collections this year. A new building for this world-famous and peculiarly American collection is now most urgently needed.

Progress in the collections and in the physical facilities of the National Zoological Park was also made during the year. It is still true, however, that this great collection of animals is far from adequately housed. It is certainly important that as soon as possible the outmoded wooden buildings at the Zoological Park be replaced by modern and appropriate structures. The National Zoological Park each year is visited by Americans from every State and by many foreign guests. In attendance and scope of its collections it is one of the foremost zoos of the world, but in spite of some recent improvements in its facilities, it is still far behind many modern zoological parks in the adequacy of its display techniques.

Dr. Mann Retires

Dr. William M. Mann, who served for 31 years as Director of the National Zoological Park, retired on October 31, 1956, having reached the statutory retirement age of 70. Dr. Mann was the fifth director of the National Zoological Park since it was established by Secretary Langley in 1889. Under his direction the Washington Zoo became one of the best and most representative collections of living animals in the world. The physical equipment of the Zoo also steadily improved, and during Dr. Mann's administration four modern exhibition buildings were added. Today the National Zoological Park is not only a scientific and educational center but also one of the Capital's prime tourist attractions.

For the Zoo, Dr. Mann made trips to many foreign lands to obtain live animals for the collection. For example, in 1926 he headed the Smithsonian-Chrysler Expedition to East Africa, in 1937 a National Geographic Society Expedition to the East Indies, and in 1940 the

Smithsonian-Firestone Expedition to Liberia. He was particularly successful in obtaining rare species never before exhibited, and through his many associations with zoologists, animal collectors, dealers, circuses, and other zoos the world over he maintained the National Zoological Park at a high level.

Dr. Mann continues his association with the Smithsonian in the capacity of Honorary Research Associate. Dr. Theodore H. Reed, of Portland, Oreg., chief veterinarian of the Zoo since July 1955, was named Acting Director of the National Zoological Park on November 1, 1956.

THE ESTABLISHMENT

The Smithsonian Institution was created by act of Congress in 1846, in accordance with the terms of the will of James Smithson, of England, who in 1826 bequeathed his property to the United States of America "to found at Washington, under the name of the Smithsonian Institution, an establishment for the increase and diffusion of knowledge among men." In receiving the property and accepting the trust, Congress determined that the Federal Government was without authority to administer the trust directly, and, therefore, constituted an "establishment," whose statutory members are "the President, the Vice President, the Chief Justice, and the heads of the executive departments."

THE BOARD OF REGENTS

On December 14, 1956, the Institution suffered a deep loss in the death of one of its newest Regents, Dr. Everette Lee DeGolyer. This vacancy in the class of citizen Regents has been filled by the election of Dr. John Nicholas Brown, of Providence, R. I. The membership of the Board is now up to full complement, that is, 14 members: 6 congressional members, 6 citizen members, the Vice President, and the Chief Justice of the United States.

The roll of Regents at the close of the fiscal year was as follows: Chief Justice of the United States Earl Warren, Chancellor; Vice President Richard M. Nixon; members from the Senate: Clinton P. Anderson, Leverett Saltonstall, H. Alexander Smith; members from the House of Representatives: Overton Brooks, Clarence Cannon, John M. Vorys; citizen members: John Nicholas Brown, Arthur H. Compton, Robert V. Fleming, Crawford H. Greenewalt, Caryl P. Haskins, and Jerome C. Hunsaker.

On the evening of January 17, 1957, preceding the annual meeting, an informal dinner meeting of the Board was held in the main hall of the Smithsonian Building amid various exhibits showing phases of the work being carried on at present. Dr. Waldo L. Schmitt, head curator of zoology of the U. S. National Museum, gave an ac-

count of the Smithsonian-Bredin Belgian Congo Expedition, and George B. Griffenhagen, curator of the division of medicine and public health, spoke about the Old World Apothecary Shop. The Secretary gave a brief résumé of his trip to Europe in the fall of 1956 to visit museums in connection with planning for the new Museum of History and Technology.

The regular annual meeting of the Board was held on January 18, 1957. The Secretary presented his published annual report on the activities of the Institution together with the 1956 Annual Report of the United States National Museum. Dr. Robert V. Fleming, Chairman of the Executive and Permanent Committees of the Board, gave the financial report for the fiscal year ended June 30, 1956. The usual resolution was passed authorizing expenditures of the income of the Institution for the fiscal year ending June 30, 1958.

FINANCES

A statement on finances, dealing particularly with Smithsonian private funds, will be found in the report of the executive committee of the Board of Regents, page 196.

APPROPRIATIONS

Funds appropriated to the Institution for its regular operations for the fiscal year ended June 30, 1957, total \$4,425,000 obligated as follows:

| | |
|---|-------------|
| Management..... | \$81, 010 |
| United States National Museum..... | 1, 782, 690 |
| Bureau of American Ethnology..... | 61, 891 |
| Astrophysical Observatory..... | 302, 510 |
| National Collection of Fine Arts..... | 48, 185 |
| National Air Museum..... | 120, 156 |
| International Exchange Service..... | 87, 513 |
| Canal Zone Biological Area..... | 30, 274 |
| Maintenance and operation of buildings..... | 1, 442, 364 |
| Other general services..... | 467, 562 |
| Unobligated balance..... | 845 |

In addition to the sum of \$2,288,000 appropriated last year for the preparation of plans and specifications for the new Museum of History and Technology, the Institution received this year an appropriation of \$33,712,000 for the construction of this building.

Besides these direct appropriations, the Institution received funds by transfer from other Government agencies as follows:

| | |
|--|------------|
| From the District of Columbia for the National Zoological Park.... | \$720, 000 |
| From the National Park Service, Department of the Interior, for the River Basin Surveys..... | 108, 500 |

VISITORS

Visitors to the Smithsonian group of buildings during the year reached an all-time high of 4,841,818, nearly 700,000 more than the previous year. April 1957 was the month of largest attendance, with 726,290; May 1957 second, with 661,857; August 1956 third, with 660,567. Largest attendance for a single day was 73,141 on May 4, 1957, the largest number ever so recorded. On the same day 33,964 visitors came to the Arts and Industries Building alone. Table 1 gives a summary of the attendance records for the five buildings. These figures, when added to the 942,196 visitors recorded at the National Gallery of Art and the 3,998,546 estimated at the National Zoological Park, make a total number of visitors at the Institution of 9,782,560.

TABLE 1.—*Visitors to certain Smithsonian buildings during the year ended June 30, 1957*

| Year and month | Smithsonian Building | Arts and Industries Building | Natural History Building | Aircraft Building | Freer Building | Total |
|----------------|----------------------|------------------------------|--------------------------|-------------------|----------------|-----------|
| <i>1956</i> | | | | | | |
| July..... | 114,497 | 262,770 | 125,623 | 84,245 | 13,899 | 601,034 |
| August..... | 112,025 | 310,283 | 129,086 | 94,873 | 14,300 | 660,567 |
| September..... | 49,928 | 129,610 | 76,206 | 38,118 | 8,045 | 301,907 |
| October..... | 38,593 | 108,986 | 68,549 | 41,251 | 7,769 | 265,148 |
| November..... | 34,687 | 96,789 | 61,743 | 29,697 | 7,354 | 230,270 |
| December..... | 20,763 | 56,647 | 47,983 | 19,504 | 4,754 | 140,651 |
| <i>1957</i> | | | | | | |
| January..... | 21,964 | 54,766 | 50,565 | 19,744 | 4,124 | 151,163 |
| February..... | 30,422 | 89,111 | 69,457 | 34,033 | 5,849 | 228,872 |
| March..... | 46,485 | 126,117 | 91,452 | 42,306 | 7,776 | 314,136 |
| April..... | 121,295 | 345,873 | 156,334 | 88,336 | 14,452 | 726,290 |
| May..... | 110,512 | 303,595 | 156,318 | 80,141 | 11,291 | 661,857 |
| June..... | 90,492 | 240,651 | 126,725 | 80,225 | 12,830 | 550,923 |
| Total..... | 791,663 | 2,125,198 | 1,160,041 | 652,473 | 112,443 | 4,841,818 |

LECTURES

In 1931 the Institution received a bequest from James Arthur, of New York City, a part of the income from which was to be used for an annual lecture on some aspect of the study of the sun. The twenty-fourth Arthur lecture was delivered in the auditorium of the Natural History Building on the evening of April 10, 1957, by Dr. Thomas Gold, professor of astronomy at Harvard University. This illustrated lecture, on the subject "Cosmic Rays from the Sun," will be published in full in the general appendix of the Annual Report of the Board of Regents of the Smithsonian Institution for 1957.

Prof. George E. Mylonas, chairman of the Department of Art and Archaeology at Washington University, St. Louis, and professor of

archaeology at the University of Athens, Greece, delivered a lecture on "The Grave Circles of Mycenae" in the auditorium of the Natural History Building on the evening of February 6, 1957. This lecture was sponsored jointly by the Smithsonian Institution and the Archaeological Institute of America.

Several lectures were also sponsored by the Freer Gallery of Art and the National Gallery of Art. These are listed in the reports of these bureaus.

BIO-SCIENCES INFORMATION EXCHANGE

The calendar year 1956 marked a high peak in the activities of the Bio-Sciences Information Exchange. Increased governmental support of research in the bio-sciences was reflected in the volume of research registered; the greater use of the services of the Exchange is indicative of the growing recognition of its value.

This agency, operating within the Smithsonian under funds made available to the Institution by other governmental agencies, acts as a clearinghouse for current research in the life sciences. Abstracts of on-going research are registered by investigators engaged in biological, medical, and psychological research and in limited aspects of research in the social sciences. Through an extensive system of subject indexing, these abstracts are provided upon request and without charge to researchers in research institutions. Through this simple mechanism, the Exchange maintains a communication system which precedes publication and prevents unknowing duplication. For granting agencies and properly constituted committees it prepares extensive surveys of research in broad areas.

The Exchange is growing in scope and in content. Its body of information now consists of 14,000 active research projects and its use by individual scientists and by committees is increasing in proportion.

SUMMARY OF THE YEAR'S ACTIVITIES

National Museum.—The year's accessions to the national collections aggregated 647,750 specimens, somewhat less than last year, bringing the total catalog entries in all departments to 44,377,488. Some of the outstanding items received during the year included: In anthropology, an Egyptian ibis statuette of about 1800 B. C., a fine collection of English and American furniture and glass, the first cigar-store wooden Indian the Museum has ever had, and invaluable additions to the Greenwood collection of Americana; in zoology, several collections of mammals of medical importance, a fine lot of Belgian Congo birds, fishes from many parts of the world, including one collection of nearly 17,000 specimens from the southern United States, more than 168,000 specimens of ectoparasites and 60,000 beetles in

one collection, 27,600 specimens of marine invertebrates from the Smithsonian-Bredin Caribbean expedition, and 2,900 Australian mollusks; in botany, an important collection of type specimens from Central America, as well as desirable lots of plants from Iran, the West Indies, Cuba, Ecuador, Brazil, East Africa, and the Marshall Islands; in geology, several fine gems and mineral specimens, seven meteorites new to the collections, several thousand invertebrate fossils, and about 100 fossil mammalian specimens collected from the Eocene of Wyoming; in engineering and industries, about 20 original instruments relating to the history of the telephone, a Robertson milling machine of 1852, a full-sized pirogue, an X-ray tube of Roentgen, a complete set of hospital-ward fixtures of about 1900, and examples of the graphic art of Whistler, Gauguin, Bonnard, Rouault, Picasso, and Matisse; and in history, a Pennsylvania reception room of the period 1785-90, a summer service uniform once worn by President Eisenhower, and many desiderata in the fields of philately and numismatics.

Members of the staff conducted fieldwork in Canada, Ecuador, Peru, Brazil, Panama, Philippine Islands, Society Islands, Mexico, Europe, Bermuda, and many parts of the United States.

The exhibits-modernization program was successfully continued, and three new halls were opened to the public—the Hall of Power Machinery, the Hall of Everyday Life in Early America, and the Hall of North American Mammals. A new telephone exhibit also received much attention. Seven new exhibit units were installed in the North American Indian Hall.

Bureau of American Ethnology.—The staff members continued their research and publication in archeology and ethnology: Dr. Stirling conducted archeological work in Ecuador, Dr. Roberts continued as Director of the River Basin Surveys, Dr. Collins studied anthropological materials in European museums, and Dr. Sturtevant did fieldwork on the Seneca and the Florida Seminole.

Astrophysical Observatory.—The APO continued its researches in solar astrophysics as well as its meteoritic studies, adding several members to its staff and notably increasing its publication activities. Of great current interest is the Observatory's so-called Moonwatch program—the optical tracking of the earth satellite to be launched as a part of the International Geophysical Year. The division of radiation and organisms continued its research on the role of light in regulating growth in plants.

National Collection of Fine Arts.—The Smithsonian Art Commission accepted for the Gallery 62 oil paintings, 2 watercolors, 3 etchings, 1 miniature, and 1 vase, and a collection of 59 French and English fans. The Gallery held 15 special exhibits during the year, while

the Smithsonian Traveling Exhibition Service circulated 86 exhibitions, 81 in the United States and 5 abroad.

Freer Gallery of Art.—Purchases for the collections of the Freer Gallery included Chinese bronzes, jade, paintings, and pottery; Japanese lacquer work, paintings, and pottery; Persian gold work and Persian, Armenian, and Iraq manuscripts; and an Indian (Mughal) painting. The Gallery continued its program of illustrated lectures in the auditorium by distinguished scholars in Eastern art. Air-conditioning of the building was completed during the year.

National Air Museum.—During the year 1,050 specimens in 33 separate accessions were added to the aeronautical collections, including a Bell VTOL aircraft with 2 jet engines, valuable material pertaining to planes of the Wright brothers, several fine scale models, and a large and historically valuable collection of instruments.

National Zoological Park.—The Zoo accessioned 1,851 individual animals during the year, and 2,965 were removed by death, exchange, or return to depositors. The net count at the close of the year was 3,157. Noteworthy among the additions were a pair of white rhinoceroses, an African elephant, a young Asiatic elephant, a pair of okapis, a pair of snow leopards, a very rare Colombian red-eyed cowbird, and prized Pacific sea snakes. Visitors totaled almost 4 million.

Canal Zone Biological Area.—The year's visitors to Barro Colorado Island totaled about 750, of whom about 60 were scientists using the station's facilities for special researches, particularly in wildlife observation, forest ecology, photography, and certain insect studies.

International Exchange Service.—As the official United States agency for the exchange of governmental, scientific, and literary publications between this country and other nations, the International Exchange Service handled during the year 1,205,039 packages of such publications, weighing 827,897 pounds, an appreciable increase over last year.

National Gallery of Art.—During the year the Gallery received 650 accessions, by gift, loan, or deposit. Six special exhibits were held, and 15 traveling exhibitions of prints from the Rosenwald Collection were circulated to other museums and galleries. Exhibitions from the "Index of American Design" were given 50 bookings in 18 States, the District of Columbia, and Germany. Nearly 44,000 persons attended the various tours conducted by Gallery personnel, and about 11,500 attended the 51 auditorium lectures of Sunday afternoons. The Sunday evening concerts in the east garden court were continued.

Library.—In all, 54,316 publications were received by the Smithsonian library during the year, and 87 new exchanges were arranged. Among the gifts were several private collections of valuable material,

both of books and periodicals, entomology and geology this year being particularly well represented. At the close of the year the holdings of the library and all its branches aggregated 966,401 volumes, including 586,700 in the Smithsonian Deposit in the Library of Congress but excluding unbound periodicals and reprints and separates from serial publications.

Publications.—Eighty new publications appeared under Smithsonian imprint during the year (see Report on Publications, p. 189, for full list). Outstanding among these were: "Small Arms and Ammunition in the United States Service, 1776-1865," by Berkeley R. Lewis; "Annotated, Subject-heading Bibliography of Termites," by Thomas E. Snyder; "Crustacean Metamorphoses," by R. E. Snodgrass; "The National Aeronautical Collections," by Paul E. Garber; "American Moths of the Subfamily Phycitinae," by Carl Heinrich; "The First Quarter-century of Steam Locomotives in North America" and "Automobiles and Motorcycles in the U. S. National Museum," both by Smith Hempstone Oliver; "Seminole Music," by Frances Densmore; "Guaymí Grammar," by Ephraim S. Alphonse; "New Horizons in Astronomy," edited by Fred L. Whipple; "The World of the Dinosaurs," by David H. Dunkle; and "Meissen and Other German Porcelain in the Alfred Duane Pell Collection," by Paul V. Gardner. In all, 405,266 copies of printed matter were distributed.

Report on the United States National Museum

SIR: I have the honor to submit the following report on the condition and operations of the United States National Museum for the fiscal year ended June 30, 1957:

COLLECTIONS

During the year 647,750 specimens were added to the national collections and distributed among the six departments as follows: Anthropology, 14,004; zoology, 480,328; botany, 45,069; geology, 33,322; engineering and industries, 1,706; history, 73,321. Although fewer specimens were received than during the previous year, the total represents a normal annual accretion. Most of the specimens were received as gifts from individuals or as transfers from Government departments and agencies. The Annual Report of the Museum, published as a separate document, contains a detailed list of the year's accessions, of which the more important are summarized below. Catalog entries in all departments now total 44,377,488.

Anthropology.—An outstanding donation to the anthropological collections received in the division of archeology is a wood and bronze statuette of an ibis from the necropolis of Tuna-el-Gebel, Upper Egypt, dated about 1800 B. C. This was given by General Mohammed Naguib to President Dwight D. Eisenhower, who in turn presented it to the Institution. A large miscellaneous collection assembled by the late Monsignor John M. Cooper was donated by the Catholic University of America. This material consists of North American Indian, Eskimo, African, Philippine, and Negrito cultural objects; Coptic textiles; and an embossed gold disk from Ecuador, and other Latin American artifacts.

Ethnological gifts include two large Fijian kava bowls donated by the Government of New Zealand. Kava bowls are essential for the Fijian ceremony of *Yanggona*, or formalized drinking of kava. An antique type of Malay kris, or "Keris," was given by Ibrahim Izzudin bin Yousoff, Kelantan, Federation of Malaya. The laminated blade of this heirloom, a traditional Malay weapon, is made from meteoric iron and copper. The hilt and sheath are decorated with gold overlay in filigree with stone brilliants inset in bezels.

In anticipation of period-room installations for the new Museum of History and Technology, the following paneling and finish were

accepted: A late 18th-century drawing room from the Thomas Hancock house, Worcester, Mass., a gift of Mrs. Adelaide K. Bullen; paneled wall and woodwork from the Richard Dole house, Newbury, Mass. (about 1740), a gift of Mrs. Florence Evans Bushee; carved and decorated architectural woodwork by Samuel Field McIntire, from the interior of "Oak Hill," Peabody, Mass. (1813-14), a gift of the Jordan Marsh Co.; an original decorative finial, salvaged from the steeple of the Old North Church, Boston, after the damage by a hurricane in 1954, gift of the Lantern League of the Old North Church.

Miss Elsie Howland Quinby generously converted her loan of 118 specimens of English and American furniture and glass to a gift. Col. and Mrs. Robert P. Hare gave two 17th-century English back stools and a set of six American Sheraton "fancy" chairs. Mrs. George Maurice Morris presented, among several other gifts, a carved walnut tray and brass candlestick of about 1760. Mr. and Mrs. George H. Watson donated an early 19th-century Windsor settee, with original paint and stenciling, and an extraordinary hollow-tree-trunk grain barrel. Through the Virgil M. Hillyer fund a North Devonshire pottery oven from Bideford, England, was purchased.

Mrs. Marjorie Merriweather Post was the donor of the only cigar-store wooden Indian ever acquired by the Museum. Several important examples of 18th- and 19th-century American blown glass were presented by W. Daniel Quattlebaum. These include New York, New Jersey, and New England types, as well as a rare cut-glass tumbler with an embedded ceramic cameo bust of Lafayette, made at the Bakkewell works in Pittsburgh on the occasion of Lafayette's visit to America in 1824. An entire collection of 173 glass paperweights, mostly of European and American origin, was the gift of Aaron Straus.

In order to augment the exhibits in the hall "Everyday Life in Early America," several large collections were accepted as loans. In addition to her previous gift of more than 1,600 objects, Mrs. Arthur M. Greenwood lent 326 specimens of Americana, including 22 examples of primarily American 17th- and 18th-century silver, rare children's books and hornbooks, Indian captivity accounts and broadsides, numerous dolls, and many articles of domestic use. Two specimens of North Devonshire pottery excavated at Jamestown, Va., were lent by the National Park Service.

In exchange with the Institute and Museum of Anthropology, Moscow State University, the division of physical anthropology received a cast of a child's skull and lower jaw from the Mousterian cultural period of the Crimea. The Moscow State University received a cast of the Tepexpán skull in return. This exchange resulted from a visit by the Russian delegation following the Fifth International Congress of Anthropology and Ethnology in Philadelphia.

Zoology.—As reservoir hosts, transmitters, and carriers of disease, mammals are intensively studied and collected the world over by special agencies and commissions whose efforts have resulted in some of the more important accessions received by the division of mammals in recent years. This year in cooperation with the Armed Forces Epidemiological Board and the University of Pittsburgh, Dr. David H. Johnson, curator of mammals, collected 656 specimens of bats and other small mammals in central Luzón, Philippine Islands. More than 500 other mammals from Panama and the Canal Zone accrued to the collection, largely from the field collecting of the personnel of the 25th and 7451st Preventive Medicine Survey Detachments of the U. S. Army, and in part by Dr. Karl B. Koford, Dr. Alexander Wetmore, and by Dr. Robert K. Enders of Swarthmore College. Donated by Dr. Enders also were 376 mammals from Alaska, Colorado, Massachusetts, Wyoming, and Saudi Arabia. The Pan American Sanitary Bureau of the World Health Organization contributed 38 rodents from Peru. Type specimens were received from Kenneth Walker, Tacoma, Wash., from the Office of Naval Research through the University of Kansas, and from Kenneth S. Norris and William N. McFarland.

This year's more important ornithological accessions included 118 Belgian Congo bird skins, representing 59 forms new to the Museum, received as an exchange from the Institut Royal de Sciences Naturelles, Brussels; 23 birds from the Caroline Islands, a transfer from the Pacific Science Board, National Research Council; 10 Venezuelan birds, including the type specimens of 8 new forms, deposited by Dr. William H. Phelps, Caracas; by deposit from the Smithsonian Institution 817 skins, 16 skeletons, 3 nests, and 5 sets of eggs of birds, collected in Panama by Dr. A. Wetmore.

Noteworthy collections of New World amphibians and reptiles were received as gifts from the following donors: Jerry D. Hardy, Catonsville, Md., 702 specimens from Cuba; William L. Witt, Arlington, Va., 208 reptiles and amphibians; the Naturhistorisches Museum, Vienna, Austria, 98 frogs from Brazil; Dr. John W. Crenshaw, Jr., Columbia, Mo., 52 turtles; Dr. W. G. Lynn, Washington, D. C., 23 frogs from Jamaica and Antigua, B. W. I. For type material in this field the Museum is also indebted to the University of Colorado, to the Natural History Museum of the University of Illinois, and to Dr. Gordon Thurow, Braddock Heights, Md.

The largest accession to the fish collection was the gift of Dr. William R. Taylor, associate curator, representing his comprehensive collection of 16,821 specimens gathered from the southern United States over several years. Other sizable fish collections were received as follows: 4,329 specimens from Paraguay donated by Dr. C. J. D.

Brown, Montana State College; 1,653 specimens of West Indian fishes obtained on the Smithsonian-Bredin Caribbean Expedition and deposited by the Institution; 190 fresh-water fishes from Colombia, the gift of Dr. George Dahl. Included in 8 accessions numbering nearly 700 specimens were 6 holotypes and 598 paratypes of fishes described by one or another of the donors from various parts of the world: Dr. J. J. Hoedeman, Zoölogisch Museum, Amsterdam; Daniel M. Cohen, Stanford University; Drs. Reeve M. Bailey, University of Michigan, and William R. Taylor, U. S. National Museum; Wayne J. Baldwin, University of California at Los Angeles; Dr. Andreas B. Rechnitzer, U. S. Navy Electronics Laboratory, San Diego, Calif.; Dr. John C. Briggs, University of Florida; William C. Schroeder, Museum of Comparative Zoology, Harvard University; Dr. Boyd W. Walker, University of California at Los Angeles; and Victor G. Springer, University of Texas.

The largest accession accruing this year to the division of insects consisted of 168,531 specimens of ectoparasites and transferred from the Walter Reed Army Medical Center, Department of the Army. Ernest Shoemaker of Brooklyn donated his personal collection of 60,338 specimens, chiefly Coleoptera, all exquisitely prepared and including 101 *Morpho* butterflies, many of which are rare. Dr. Colvin L. Gibson of Memphis presented 4,327 butterflies and moths, and some representatives of other groups collected in Mexico, the British Solomon Islands, and the United States. Associate Curator O. L. Cartwright presented 11,400 specimens of insects which he collected in Arizona, New Mexico, and Texas. A gift of 6,546 named lepidopterous larvae, mostly from western United States, which were associated with reared examples in the economically important family of cutworm moths, was received from S. E. Crumb, Puyallup, Wash. Dr. J. F. Gates Clarke, curator, contributed 4,801 miscellaneous insects, mostly from the State of Washington. Other noteworthy accessions included 5,347 insects from Africa and South, Central, and North America, received from N. L. H. Krauss of Honolulu; 3,753 North Dakota spiders, donated by J. M. Davis, Silver Spring, Md.; and 10,000 miscellaneous insects from Thailand, received from the International Cooperation Administration.

Aside from gifts bringing additional type material to the Museum's marine invertebrate collections, the following are deemed particularly worthy of note: 27,600 specimens from the Smithsonian-Bredin Caribbean Expedition deposited by the Institution; 1,757 crustaceans and other invertebrates from survey vessel collections in the Gulf of Mexico and off the southeastern United States, transferred from the U. S. Fish and Wildlife Service; 176 identified specimens of 40 species of pelagic copepods from Sweden and South

Africa donated by Dr. Karl Lang, Naturhistoriska Riksmuseet, Stockholm, Sweden; 1,828 shrimps, crayfishes, and other invertebrates given by Dr. Horton H. Hobbs, Jr., University of Virginia; 160 identified specimens of 13 species of mysidacean crustaceans from the vicinity of Plymouth, England, presented by Dr. Olive S. Tattersall, through Dr. Isabella Gordon; and 2 specimens of Cephalocarida, the recently discovered crustacean subclass, received from Howard L. Sanders, Woods Hole Oceanographic Institution. Donors of type material included the late Dr. Raymond C. Osburn, Ohio State University; Dr. E. Ruffin Jones, University of Florida; Maureen Downey, Beaufort, N. C.; Dr. Trevor Kincaid, Seattle, Wash.; Mrs. Mildred S. Wilson, Anchorage, Alaska; Dr. J. T. Penney, University of South Carolina; Gordon Clark, University of Maryland; Dr. Alejandro Villalobos F., Instituto de Biología, Mexico; Dr. N. T. Mattox, University of Southern California; and the Scripps Institution of Oceanography, University of California.

Among the outstanding mollusk accessions for the year may be enumerated the following: 2,900 Australian specimens donated by Samuel W. Rosso, Hattiesburg, Miss.; the deposit of 1,380 mollusks received from the Smithsonian-Bredin Caribbean Expedition; 673 specimens of land and fresh-water snails from Libya, collected by Dr. Rolf Brandt, and purchased through the Frances Lea Chamberlain Fund; 900 specimens of land and fresh-water mollusks from the Solomon Islands, New Britain, and New Caledonia, from James R. Hood; and 84 marine mollusks from South Africa, received from the University of Cape Town, through Prof. J. H. Day. Types of helminths were donated by Dr. Elon E. Byrd, Athens, Ga.; Dr. Thomas C. Cheng, Charlottesville, Va.; Dr. Paul R. Burton, Coral Gables, Fla.; and Dr. Leland S. Olsen, Lincoln, Nebr.

Botany.—An important collection of 196 type specimens of Central American plants was contributed by the Escuela Agrícola Panamericana. Other gifts included 210 specimens of plants of Iran collected and presented by Justice William O. Douglas; and 697 Cuban plants from Manuel López Figueiras, Santiago de Cuba. Dr. A. C. Smith obtained 4,047 specimens of West Indian plants on the Smithsonian-Bredin Caribbean Expedition, and C. V. Morton collected 4,927 specimens of plants in Cuba. E. P. Killip obtained 1,505 specimens for the Institution on the Isle of Pines, Cuba, and in southern Florida and Texas.

Among the interesting collections received in exchange were 800 Brazilian plants, mostly from the Amazon region, from the Instituto Agronómico do Norte, Belém, Pará, Brazil; 1,640 plants of Ecuador obtained by Dr. Eric Asplund; 1,058 specimens collected in Hispaniola by E. L. Ekman from the Naturhistoriska Riksmuseet, Stock-

holm, Sweden; 232 specimens obtained in Asia Minor by E. K. Balls from the Royal Botanic Garden, Edinburgh, Scotland; 621 plants collected in East Africa by H. J. Schlieben from the Missouri Botanical Garden, and 1,353 specimens of plants of Hong Kong, California, and Mexico from the University of Michigan.

Extensive collections of plants of Santa Catarina, comprising 2,479 specimens, were received from the Herbário "Barbosa Rodrigues," Itajaí, Santa Catarina, Brazil, with a request for identifications. The Los Angeles County Museum sent, for study and report by herbarium specialists, 239 specimens from the collections made by E. Yale Dawson on the Machris Brazilian Expedition.

There were transferred from the U. S. Geological Survey, Department of the Interior, 2,142 specimens collected by Dr. F. R. Fosberg in the Marshall Islands, and from the Agricultural Research Service, Department of Agriculture, 870 specimens collected by F. J. Hermann in Canada and northwestern United States.

Geology.—Outstanding among the gifts of minerals is an unusual scapolite from Itrongahy, Madagascar, from John B. Jago, and an exceptional barite from Sterling, Colo., given by Arch Oboler. Some of the newly described minerals presented are: cardosonite, Spain, by Dr. I. Asensio Amor; kingite, Australia, from the Commonwealth Scientific and Industrial Research Organization; ferroselite, Montrose County, Colo., from Howard Bowers; heidornite, Germany, from Prof. Dr. W. V. Engelhardt; hibonite, Madagascar, from John B. Jago; tertschite, Turkey, from Dr. Heinz Meixner; vayrynenite, Finland, from Mary Mrose; and bøgildite, Greenland, from Hans Pauly.

Several outstanding additions were made to the gem collection by exchange, including an exceptionally fine 18.3-carat canary-yellow diamond from South Africa, a 51.9-carat yellow sapphire from Burma, and a 68.85-carat brilliant-cut sphalerite from Utah. A 13.50-carat andalusite from Brazil and an 11.80-carat star spinel from Ceylon showing four separate 6-rayed stars were purchased through the Chamberlain Fund for the Isaac Lea collection.

Of the 131 specimens added to the Roebling collection by purchase, the outstanding items are: schoepite and soddyite from Shinkolobwe in the Belgian Congo, and hambergite from San Diego County, Calif. Newly described species added to the Roebling collection are: coffinite from Utah; kettnerite from Czechoslovakia; hawleyite from the Yukon in Canada; and isokite from Northern Rhodesia.

Significant additions to the Canfield collection include two 6-inch crystals of enargite from Peru; a 6½-ounce gold nugget from the Yukon, Alaska, mined in 1896; several fine groups of showy wulfenite crystals from Arizona; and two exceptionally fine crystals of blue and yellow sapphire from Burma.

Three meteorites new to the collection acquired as gifts were Bonita Springs, Lee County, Fla., from E. P. Henderson; Kaufman, Kaufman County, Tex., from Mrs. Carl C. Hinrichs; and Mayday, Riley County, Kans., from Prof. Walter S. Houston. Four meteorites, also new to the collection, were received as exchanges: St. Peters, Graham County, Kans.; Kunashak, Elenovka, and Sikhote-Alinskii, from the Union of Soviet Socialist Republics.

Important gifts received in the division of invertebrate paleontology and paleobotany are: 750 Tertiary mollusks from Virginia, North Carolina, and Florida given by Shelton P. Applegate; 500 specimens of Permian brachiopods from Tasmania, from Dr. Kenneth E. Caster; 93 pleosponges from South Australia, the gift of B. Flounders; 66 type and figured specimens from the Pennsylvania rocks of western Maryland from Joseph Lintz, Jr.; 4,665 specimens of crinoids and other fossils representing the private collection of the late Dr. Edwin Kirk, received from Mrs. Kirk; 400 specimens of Cretaceous Foraminifera from Egypt donated by Rushdi Said; and 311 Miocene mollusks from Peru, given by the Johns Hopkins University.

An important collection of 500 Tertiary brachiopods from Okinawa was transferred from the U. S. Geological Survey. Among the accessions obtained by exchange were 2,695 specimens of Foraminifera from Poland; 158 Tertiary brachiopods from New Zealand; and 894 invertebrate fossils, mostly Mesozoic and Tertiary from Japan.

Through the income of the Walcott bequest 5,322 specimens of Devonian, Mississippian, and Permian fossils were collected by Dr. G. A. Cooper, A. L. Bowsher, and J. T. Dutro, Jr., in the Glass Mountains of Texas and the San Andreas and Sacramento Mountains of New Mexico.

The division of vertebrate paleontology received outstanding specimens through purchase, fieldwork, and exchanges. Specimens of fossil fishes acquired by purchase come from the Devonian Escuminac formation on Chaleurs Bay, Canada; and a series of late Paleozoic and early Mesozoic fishes from various European localities.

Important specimens collected by Drs. C. L. Gazin and D. H. Dunkle include 100 mammalian specimens from the Eocene of Wyoming, and several good specimens of ancient dogs and horses which were obtained near Harrison, Nebr. Dr. Dunkle, with Professor Westoll, secured over 200 fossil fish specimens from Lower and Middle Devonian localities in Scotland.

Exchanges were effected that produced excellent fossil fishes and other fossil vertebrates. Several types of Triassic fishes from Greenland and casts of Devonian amphibians were obtained from the Danish Mineralogical Museum. A large skeleton of a Cretaceous fish was obtained from the Bureau of Economic Geology of the University of

Texas, and Dartmouth College exchanged six primitive jawless ostracoderms from Oesel Island in the Baltic. An exchange of value, consisting of nine jaws and maxillae of primitive perissodactyls and artiodactyls, was obtained from the Muséum de Sciences Naturelles, Lyon, France.

Engineering and Industries.—In connection with the development of the new exhibit of telephony, about 20 original instruments showing the evolution of the telephone from 1880 to the present day were added to the collections of the division of engineering. These specimens were donated by Bell Telephone Laboratories, Stromberg-Carlson Co., the Bell Telephone Co. of Canada, North Electric Co., Western Electric Co., and the Ohio Bell Telephone Co.

All sections in the division received important new accessions in preparation for exhibition in the Museum of History and Technology. A specimen of particular historical interest added as a loan to the collection of machine tools is a Robertson milling machine of 1852, from Yale University. The section of light machinery acquired a fine French astronomical clock, of about 1800, featuring a planetarium enclosed in a glass sphere etched with the constellations, thus exhibiting particularly well the astronomical associations of timekeeping. A full-sized pirogue, made in the manner of the Acadians, was presented to the transportation section by Esso Standard Oil Co., together with a film recording the process of its fabrication. An elegant Queensbody basket phaeton was given by Mrs. William A. Frailey. The collection relating to instructional mathematics was augmented considerably with the receipt, from Prof. Frances E. Baker, of a set of 131 mathematical models.

The division of medicine and public health added to its collection the third X-ray tube of the discoverer of X-rays, Wilhelm Konrad Roentgen, a gift of the General Electric Co. For the hospital exhibit in the Museum of History and Technology, a complete set of hospital ward fixtures of about 1900 was received from the Massachusetts General Hospital. The materia medica collection obtained a number of additional examples of patent medicines, such as Bateman's Pectoral Drops, presented by Ronald R. McCandless, Owen H. Waller, and A. P. Whealton; Godfrey's Cordial, presented by Robert Russell and A. P. Whealton; and Porter's Curative Sugar Pills, from Samuel A. Aker, David E. Kass, and George C. Kass.

Among the more important specimens acquired by the division of crafts and industries is an 18th-century Don Quixote tapestry presented by Mrs. Kermit Roosevelt, a rustic copperplate printed fabric dated 1761, from Mrs. Betty H. Harriman; and a copperplate print stitched into a quilt top, from Mrs. Nicholas Satterlee. In the section of agriculture, a model of the Hussey reaper of 1833 was constructed by

Donald Holst of the office of exhibits; a Pennsylvania bar share plow was donated by Daniel G. H. Leshner; and an early threshing machine by James W. Brown.

Preparation of exhibits for the new museum made it possible for the division of graphic arts to acquire a number of important prints. Among these are "St. Catherine with the Wheel," a hand-colored anonymous woodcut dated 1465-70, and examples of the graphic work of J. M. Whistler, Paul Gauguin, Pierre Bonnard, Muirhead Bone, Georges Rouault, Pablo Picasso, Henri Matisse, and others. An outstanding collection of materials representing the history of motion-picture photography, comprising 864 items, was received as a bequest from Gatewood W. Dunston.

History.—The division of civil history acquired a notable reception room that was originally installed in a house near Kutztown, Berks County, Pa., during the period 1785-90. This room corresponds in size, plan, locale, period, and original usage to the second-floor front drawing room of the Philadelphia Presidential Mansion as it appeared during Washington's second administration.

The Ladies' Hermitage Association, Nashville, Tenn., presented a buff-and-gold china bowl from one of the dinner services used at the White House during the administration of President Andrew Jackson. A plate and a cup and saucer representative of the State services made by Wedgwood for the White House for use during the Theodore Roosevelt administration were presented by Josiah Wedgwood & Sons, Inc.

A most interesting addition to the costumes collection is a gold brocade shoe for a woman of the early 18th century with a matching gold brocade clog, a gift of Mrs. Brookings T. Andrews.

The military history collections were enhanced by the gift from President Dwight D. Eisenhower of a summer service uniform of a General of the Army worn by him during his term as Commanding General, Supreme Headquarters, Allied Powers Europe. Twelve military paintings by the celebrated military artist Charles Hoffbauer were presented by Mrs. John Nicholas Brown.

Outstanding among the specimens received in the division of naval history was a series of six oil paintings of naval actions in the Pacific Ocean during World War II which came as a gift of the artist Clarence J. Tibado.

An important accession received in the division of numismatics is an original pantograph invented and built by Christian Gobrecht, a foremost United States Mint engraver, together with various engravings and plate proofs of State bank notes made by him, the gift of Mrs. C. F. Wolters. Outstanding among the specimens presented by Paul A. Straub are a broad gold 8-ducat piece struck in 1617 in Qued-

linburg by Dorothea, Duchess of Saxony, and a ducat, dated 1688, struck by August Friedrich of Holstein-Gottorp.

A newcomer to the list of donors of philatelic material is Harry L. Lindquist, publisher of *Stamps* magazine, who presented his collections of Danish and Swedish booklet panes, including many of great rarity. Former Postmaster General James A. Farley converted one section of his valuable philatelic holdings from loan to gift during the year.

Philip H. Ward, Jr., of Philadelphia, donated a considerable number of United States and foreign stamps—to continue his ranking as the “oldest” continuing donor, having first evidenced his support of the national postage stamp collection as long ago as 1915. B. H. Homan, Jr., of New York donated 18 original drawings for Ecuadorean stamps, and 114 French pre-stamp covers.

EXPLORATION, FIELDWORK, AND RELATED TRAVEL

Near the close of the past fiscal year Dr. T. Dale Stewart, curator of physical anthropology, investigated the burial site of an adult male Indian on the bank of York River opposite West Point, Va. Portions of the skeleton were unearthed. Trephined skulls from Bolivia in the American Museum of Natural History, New York City, and from the central highlands of Peru in the Peabody Museum, Cambridge, were examined by Dr. Stewart April 2-7, 1957, to advance completion of a research project.

Frank M. Setzler, head curator of anthropology, and Dr. Clifford Evans, associate curator of archeology, attended during September 1956 the Fifth International Congress of Ethnological and Anthropological Sciences at Philadelphia. During April 1957 Mr. Setzler visited New Martinsville, W. Va., to survey and discuss a cooperative arrangement for the excavation of a prehistoric Indian mound on the property of the Columbia-Southern Chemical Corp. Plans are now being formulated to proceed with this project during the next fiscal year.

Dr. Clifford Evans, associate curator of archeology, and Dr. Betty J. Meggers, research associate, with support from a grant from the American Philosophical Society, excavated 12 archeological sites on the Río Napo and its tributaries on the eastern slope of the Ecuadorian Andes from October through December 1956. The results of this work indicate that the Río Napo culture is ancestral to the Marajoara culture at the mouth of the Amazon, although the ultimate origin of the Napo culture is still unknown. During January and February 1957, under a cooperative arrangement with Sr. Emilio Estrada, Director of the Museo Arqueológico “Victor Emilio Estrada” of Guayaquil, they continued research begun in

1954 on the coast of Ecuador. Additional sites were investigated in the Guayas Province to expand knowledge of the Formative Period cultures and establish links with cultures of this period in Middle America and Peru. En route to Venezuela, 2 weeks were spent in Colombia examining collections in Bogotá, Barranquilla, and Cartagena and consulting with Colombian anthropologists.

On arrival at Caracas, Venezuela, these two investigators were invited by Dr. José M. Cruxent, Director, Museo de Ciencias Naturales, to accompany an expedition sponsored by that museum and the Universidad Central de Venezuela to the Río Ventuari, a headwaters tributary of the Río Orinoco. Some five weeks were devoted to stratigraphic excavations of 30 or 40 former sites of human occupation in this region. The materials obtained will permit a more adequate interpretation of the cultural level relationships of the former inhabitants of Brazil, the Guianas, Colombia, and Ecuador. Drs. Evans and Meggers returned to Washington on April 5, 1957.

Dr. Waldo R. Wedel, curator of archeology, participated, May 2-4, 1957, in a symposium held at the University of Wisconsin, Madison, which dealt with the identity and historical implications of an archeological cultural horizon known as Oneota, ancestral to certain Siouan groups of Indians.

Dr. Marshall T. Newman, associate curator of physical anthropology, under a research project financed by a grant from the National Science Foundation, conducted studies in physical anthropology, nutrition, dietary habits, blood analyses, bone density and maturation, and cultural anthropology on the Quechua-speaking Indian community of some 1,750 individuals at Hacienda Vicos in the Callejon de Huaylas, North Central Sierra, Peru. Blood samples obtained during this investigation have since been studied by the Blood Grouping Laboratory, Boston, and the U. S. Public Health Service Laboratory at Framingham, Mass. Bone-density analyses and skeletal-maturation studies are being made at Pennsylvania State University from X-ray photographs of the hands of Indian school boys. Dr. Newman returned to Washington on July 27, 1957. During April 1957 Dr. Newman consulted with specialists of the Fels Research Institute staff at Yellow Springs, Ohio, relative to age assessments from carpal X-rays, tooth eruption data, and metric growth data obtained at Hacienda Vicos.

C. Malcolm Watkins, associate curator of ethnology, in the interval between October 1 and 8, 1956, arranged for the shipping of cultural-history materials from Mrs. Arthur M. Greenwood's home in Marlboro, Mass., sorted the woodwork from the Thomas Hancock house in Worcester, and packed and shipped tiles given by E. Stanley Wires of Wellesley Hills.

Conrad V. Morton, curator of cryptogams, during August 1956, participated in a field trip organized by the American Fern Society on the Gaspé Peninsula, Canada. On the return trip Mr. Morton attended the meetings of the American Institute of Biological Sciences at Storrs, Conn.

From October 1956 to April 1957, Dr. Lyman B. Smith, curator of phanerogams, conducted field studies of the flora of southern Brazil under a grant from the National Science Foundation and in collaboration with the *Herbário "Barbosa Rodrigues."* Over 5,000 plants were collected on the planalto of Santa Catarina and adjacent regions for phytogeographical research on the origin of the flora of southern Brazil.

During February 1957, Dr. Herbert Friedmann, curator of birds, was selected to inaugurate the recently endowed "Lida Scott Brown Lectureship" at the University of California at Los Angeles. Previously, in August, he studied the African parasitic weaverbirds in the Chicago Museum of Natural History in furtherance of a monograph now in course of preparation.

On April 30, 1957, Dr. Charles O. Handley, Jr., associate curator of mammals, was detailed to conduct preliminary mammal surveys in eastern Panama in cooperation with the yellow-fever project of the Gorgas Memorial Laboratory. Fieldwork continued through the month of June and Dr. Handley returned to the Museum on June 28, 1957.

At the invitation of Dr. William McD. Hammon, chief of the department of epidemiology and microbiology, Graduate School of Public Health, University of Pittsburgh, Dr. David H. Johnson, curator of mammals, joined a virus-research group from July 24 to October 2, 1956, in the vicinity of Manila and Clark Airbase, Luzón, Philippine Islands. This survey of the mosquito-borne virus diseases affecting wild animals and man was supported by the Armed Forces Epidemiological Board, U. S. Department of Defense.

On July 27, 1956, Dr. Ernest A. Lachner, associate curator of fishes, returned to Washington following completion of his studies under a fellowship awarded by the John Simon Guggenheim Memorial Foundation. Dr. Lachner is preparing monographic studies of the circumtropical marine fish families Apogonidae (cardinalfishes) and Mullidae (goatfishes) and found it necessary to examine the collections preserved in the British Museum (Natural History), London; the Zoological Museum, Amsterdam; the Rijksmuseum van Natuurlijke Historie, Leiden; Naturhistorische Museum, Vienna; Senckenbergische Naturforschende Gesellschaft, Frankfurt; Zoologisches Museum, Hamburg; Zoological Museum, Copenhagen; the Museum of Belgian Congo, Tervuren; and the Muséum National

d'Histoire Naturelle, Paris. Dr. Lachner studied the sharksuckers (Echeneidae) in the collections of Tulane University, New Orleans, April 15-22, 1957, and added important data to his review of host specificity. Some 500 specimens of fresh-water barbeled minnows (*Hybopsis*) were examined for inclusion in a partially completed manuscript. X-rays were taken of 19 types and specimens of small, somewhat transparent fishes (Hemicichthyidae) to determine details of the osteology for incorporation in a revisional study.

In continuation of his research on sea anemones, Dr. Charles E. Cutress, associate curator of marine invertebrates, searched the invertebrate collections of the Peabody Museum of Natural History at Yale University, the Museum of Comparative Zoology at Harvard University, and the American Museum of Natural History, New York, October 22-November 6, 1956, for type specimens and material from the central and South Pacific Ocean. Dr. Cutress was detailed during February 1957 to proceed to the Museum of Wesleyan University at Middletown, Conn., for the purpose of packing and shipping zoological materials which were transferred to the national collections.

In furtherance of his taxonomic studies on scarab beetles, O. L. Cartwright, associate curator of insects, examined types of *Onthophagus*, *Ataenius*, and *Ligyris*, as well as other genera, in the collections of the Museum of Comparative Zoology at Cambridge and the Academy of Natural Sciences of Philadelphia, February 24-28, 1957. Later, April 21-24, 1957, he critically studied the types of Scarabaeidae in the Cincinnati Museum of Natural History and Purdue University, Lafayette, Ind.

Dr. Waldo L. Schmitt, head curator of zoology, and leader of the Smithsonian-Bredin Society Islands Expedition, left Washington on June 14, 1957, en route to Papeete, Tahiti. The generosity of Mr. and Mrs. Bruce Bredin, of Greenville, Del., enabled the Smithsonian Institution to charter the vessel *Mareva* for this marine biological survey of the Society Islands. The party included also Dr. Harald A. Rehder, curator of mollusks, and T. E. Bowman and Charles E. Cutress, Jr., associate curators of marine invertebrates. In the course of this cruise collections were obtained at or in the vicinity of Makatea, Tickahau, Bora-Bora, Raiatea, Tahaa, Huaheine, and Moorea.

Early in January Dr. Alexander Wetmore, research associate and former Secretary of the Smithsonian Institution, returned to Panamá in continuation of his field researches on the distribution and variation of the birdlife of the Isthmus. Through the friendly interest of Dr. Pedro Galindo of the staff of the Gorgas Memorial Laboratory for Tropical Medicine, and Diputado in the legislative body of the Republic, permission was given for work in the restricted area of the Comarca de San Blas, territory of the coastal group of the Cuna In-

dians. The field party obtained transport from Paitilla Airport, Panama City, via Cessna-180 four-passenger plane to Mandinga in the San Blas where camp was established midway between the foothills of the Cerro Azul and the sea. While much of the land had been cleared for farming, original forest remained in the swampy woodlands near the coast and over the inland hills. During a period of four weeks observations were made on approximately 200 species of birds with series of specimens prepared of those desired for special study. Friendly Indian neighbors were almost daily visitors, the colorful dress of the women being especially attractive. As this is the first collection of any extent to be made on the Caribbean coast between the Canal Zone and Puerto Obaldía on the Colombian frontier, the work has afforded especially valuable information.

Following return to the Canal Zone Dr. Wetmore spent from February 25 to 28 in the launch *Sea Raider*, Richard E. Parker of Colón, skipper, in work along the western side of the Gulf of Panama. Collections were made especially at Ensenada Venado, west of Punta Mala, and on Isla Iguana, to the north of that point, localities accessible only by boat. This year sea birds had not yet arrived to nest on the rocky islets of Los Frailes off Punta Mala, though they had been abundant there on February 6, 1956. On the return trip he examined the rocky islets of Isla Villa and Farallón de Chirú.

After a day on Cerro Azul and another near the base of Cerro Bruja, the party left by jeep for the lower end of the Azuero Peninsula. Here, from quarters obtained in the friendly village of Pedasí, studies were made in the valleys of the Río Caldera and the Río Oria, the latter accessible over a rough track practicable only in the dry season and by means of the 4-wheel drive of the jeep. Following two weeks here Dr. Wetmore crossed on March 22 by Cessna-180 plane from Las Tablas to the isolated village of Tonosí for examination of the valley of the Río Tonosí. Here he and Mrs. Wetmore were the guests of Mr. and Mrs. Harry L. Peck, long resident in the valley, who afforded all needed facilities for the work. This concluded the work for this season, except for a two-day visit to the Barro Colorado Island field station on April 2 and 3. The collections made have added definitely to our knowledge as the work centered on areas that previously had not been investigated.

During July 1956 Dr. C. L. Gazin, curator of vertebrate paleontology, accompanied by preparators Franklin L. Pearce and Theodore B. Ruhoff, proceeded to Shoshoni, Wyo., to prospect for fossil remains in several upper Eocene localities on the north side of the Wind River Basin. This fieldwork was financed by the income from the Walcott bequest. The exposures on Badwater Creek yielded additional artiodactyl remains. Subsequently a search was made for skeletal material of the Oligocene horse *Mesohippus*, in the Chadron beds

north of Harrison, Nebr. An incomplete skull of this horse and two excellent skulls of the Oligocene dog *Daphoenus* were collected. Operations were then transferred to Bitter Creek, Wyo., where portions of two skeletons of *Coryphodon* as well as small mammals were secured from quarries on exposures south of the town. After August 1 field-work was commenced on the fossiliferous exposures of Knight Eocene and presumably Evanston Paleocene in Fossil Basin near Kemmerer, Wyo., where additional materials were obtained. Several excellent specimens including a partially articulated skeleton of *Meniscotherium* were found in the New Fork tongue of the Knight formation as exposed along Alkali Creek east of Big Piney. The museum carry-all was returned to Washington on August 17, 1956.

During the last two weeks of December 1956 Dr. Gazin studied specimens of the earliest known North American primates in the collections of Princeton University, the American Museum of Natural History, and Yale University. On January 15, 1957, in accordance with a previous agreement relative to the final distribution of Pleistocene sloths and other mammals excavated near Ocu in the Republic of Panama he proceeded to Panama to unpack and assemble the fossil skeletal material returned to Dr. Alejandro Mendes, director, Museo Nacional of Panama. This assignment was completed on February 3, 1957. He examined various Eocene adapid and tarsiid primates at Princeton University and reviewed the lower Eocene anaptomorphids and other Tertiary mammals in the collections of the American Museum of Natural History, June 2-9, 1957.

During the first week of November 1956 Theodore B. Ruhoff and Shelton P. Applegate investigated a fossil whale occurrence in the vicinity of Smithfield, Va.

To obtain required specimens of fossil fishes and other early vertebrates for the exhibition series, Dr. David H. Dunkle, associate curator of vertebrate paleontology departed from Washington on August 17, 1956, for Europe. A field excursion in northern Scotland under the guidance of Prof. T. Stanley Westoll of the University of Durham resulted in the collection of Devonian fishes in such historic localities as Holburn Head Quarry, Murkle Bay, the Thurso Foreshore and Achanarras Quarry in Caithness; Edderton, Cromarty, and Ethie Burn in Rosshire; Turin Hill in Forfarshire; and the vicinity of Lesmahagow in Lanarkshire. At Copenhagen he arranged an exchange for Triassic fishes of Greenland and Madagascar with the Danish Mineralogisk Museum. Extensive collections of fossil fishes were examined at the National Museum of Sweden and the Swedish Geological Survey Museum in Stockholm. Casts of primitive tetrapods from the Devonian of Greenland were received. At Bonn, Germany, late Paleozoic and early Mesozoic fossils, including such rare forms as a lower Devonian ostracoderm and a placoderm, were selected

for the display series. Arrangements were made with Dr. B. Hauff of Holzmaden for a series of lower Jurassic fishes. At the Muséum National d'Histoire Naturelle, Paris, desirable exchanges were discussed with the staff. Dr. Dunkle returned to Washington on November 9, 1956.

Dr. Dunkle accompanied Dr. G. E. Lewis, U. S. Geological Survey, May 6-20, 1957, on a reconnaissance of the occurrence of fossil mammal-like reptiles (ictidosaurs) in the Kayenta formation on the western Navaho Indian Reservation, Ariz., with the objective of locating skeletons for exhibition.

Following approval of an exchange arrangement, Franklin L. Pearce and John E. Ott were sent on November 23, 1956, to the Museum of the University of Texas at Austin to assemble and pack for shipment a Triassic phytosaur skull and the field blocks enclosing the giant Cretaceous fish *Xiphactinus*. When preparation is completed these specimens will be incorporated in the display series.

Dr. G. A. Cooper, curator of invertebrate paleontology, was invited by the organizers of the Twenty-second International Geological Congress, Mexico City, to lead a field excursion late in August 1956 to Sonora, where the party studied the Cambrian sequence near Caborca and the Permian, Mississippian, and Devonian near Antimonio. The Walcott bequest financed the fieldwork by Dr. Cooper in the Glass Mountains of Texas and in south-central New Mexico. On August 13, 1956, while accompanied by Dr. C. O. Dunbar of Yale University, L. G. Henbest of the U. S. Geological Survey, and Dr. John Skinner of the Humble Oil Co., Dr. Cooper reviewed the Permian stratigraphy in the vicinity of Marathon, Tex., and subsequently collected additional blocks of invertebrate materials. The field truck was driven to Nogales, N. Mex., prior to the Mexican excursion. When the Geological Congress terminated, Dr. Cooper returned to Nogales where A. L. Bowsher and J. T. Dutro of the U. S. Geological Survey joined the party for the Devonian stratigraphic fieldwork in the vicinity of Silver City and Hillsboro, N. Mex. At Hillsboro, Mississippian fossils also were collected. During the last week of September and the first half of October, Alamogordo served as headquarters for the fieldwork in the San Andreas Mountains located in the White Sands Proving Ground area. Field studies in New Mexico were concluded at several localities in the Sacramento Mountains east of Alamogordo.

The income from the Walcott bequest and assistance from the National Science Foundation enabled Dr. David Nicol, associate curator of invertebrate paleontology, to conduct marine fieldwork at the Bermuda Biological Station during July 1956. He collected recent and fossil mollusks, gorgonians, Foraminifera, and fishes. Dr. Nicol

studied the Paleozoic pelecypods at the Museum of Paleontology, University of Michigan, June 9-14, 1957.

The Walcott bequest also provided funds for Dr. A. R. Loeblich, Jr., associate curator of invertebrate paleontology, and Dr. Hans Bolli of Pointe-à-Pierre, Trinidad, W. I., to study the Cretaceous-Tertiary boundary in Alabama and Texas and to collect foraminiferal samples during July 1956. The Planktonic Foraminiferal Project Fund financed Dr. Loeblich's trip to Houston, Tex., during November 1956 to obtain well cores from the subsurface Miocene of Texas and southern Louisiana from the Humble Oil Co., and to New Orleans for consultations regarding similar materials with geologists of other oil companies. In furtherance of the same project Dr. Loeblich participated in a symposium on biostratigraphy at St. Louis, Mo., during April 1957.

The exhibition and development programs for the Museum of History and Technology and the Museum of Natural History necessitated conferences with historians, scientists, and educators relative to the planning and designing of interiors and contents of exhibition halls. Travel to determine the worth of materials offered to the museum, to examine methods of exhibition and to consult with experts on preservation provided the opportunity for new staff members to become familiar with the practices and procedures employed in other museums.

Dr. Robert P. Multhauf, acting head curator of engineering and industries, conferred on October 2 and 3, 1956, with officials of the Bell Telephone Laboratories at Murray Hill, N. J., and New York City on the design of the exhibit of the telephone in preparation for installation in the museum. Late in December 1956, he examined exhibition practices in the Museum of the New York Historical Society, the Museum of Modern Art, Whitney Museum, Museum of Contemporary Crafts, and the commercial exhibits at Rockefeller Center, all in New York City. At the request of the chairman of the Crystals Section of the Committee for the Brussels Worlds Fair of 1958 and the Department of State, he participated in the conference held at Chicago on January 14, 1957. On the two following days he visited the Chicago Museum of Science and Industry to study the commercial displays and the Chicago Museum of Natural History to examine exhibit practices employed in the current renovation program.

During the period from March 26 to April 2, 1957, Dr. Derek J. Price, consultant to the department of engineering, in his search for suitable nineteenth-century chemical and physical laboratory apparatus to illustrate the history and principles of these sciences in the displays now being planned for new exhibit halls, conferred with the

staffs of the respective departments of the universities of Mississippi, South Carolina, and North Carolina. On April 15-17, 1957, he examined the collection of astrolabes, sundials, and other antique instruments now owned by Eugene Hoffman and Miss Margaret Hoffman, New York City, and studied the Samuel V. Hoffman collection of instruments at the Museum of the New York Historical Society.

On May 24, 1957, Dr. Price examined physical apparatus, including some 20 pieces said to have been made or used by Secretary Joseph Henry, housed in the Palmer Physical Laboratory of Princeton University. Through the kindness of L. C. Eichner, he was enabled to see the workshop machinery used by Henry Fitz, one of the earliest and most important astronomical telescope makers in this country, and now in the possession of his granddaughter, Mrs. Willard H. Howell of Southold, L. I. Sufficient material has been preserved to permit a restoration of the original shop in the proposed Hall of Physics.

Enquiries relative to the existence of early scientific instruments were made April 30-May 12, 1957, by Dr. Price at the University of Chicago, Museum of Science and Industry, Argonne Atomic Laboratories, and the Adler Planetarium in Chicago, and the University of Wisconsin, Madison, Wis. Among the items of especial interest examined were Italian and Danish facsimiles of important historic instruments made for the Century of Progress Exposition (1933-34) which are now mostly in storage. A continuous search is being made for historic instruments illustrating the important developments in experimental physics and in astronomy.

The recent renovation of the exhibition halls of the Wistar Institute Museum, Philadelphia, was examined by Frank A. Taylor, Assistant Director, on May 29, 1957. He paid particular attention to the techniques utilized for improvement of the exhibits.

To locate significant early types of tools as well as information regarding their inventors and their manufacturers, Robert S. Woodbury, curator of engineering, visited manufacturing firms, institutes, and museums in Providence, Worcester, Sturbridge, Cambridge, and New Haven, July 27 to August 1, 1956. A number of individuals interested in the history of tools were consulted, most of whom indicated a desire to assist in the program. Machine tools and machine shops in the Greenfield Village and the Ford Museum at Dearborn, Mich., were studied by Curator Woodbury during August 1956.

Inspection of the 1874 machine shop exhibited by the Cincinnati Milling Machine Co., the machine-tool exhibits of the Chicago Museum of Science and Industry, and the automated foundry of the Ford engine plant at Cleveland was undertaken from February 11 to 14, 1957. Plans for the hall of tools in the Museum of History and

Technology were discussed March 25-28 by Mr. Woodbury with Joseph W. Roe at Southport, Conn., and individuals acquainted with the Towne Foundation which sponsored the Museum of Peaceful Arts in New York City. Tentative negotiations were made by Curator Woodbury April 22-27, 1957, to obtain documentary data and examples of early grinding and milling machines from the Abrasive Machine Tool Co., Providence; the Norton Co., Worcester; the Fellows Gear Shaper, Springfield; Lamson and Goodnow, Shelburne Falls; the Hartford Machine Screw Co.; and the Cryder Plumbing Co., Newark.

Edwin A. Battison, associate curator of light machinery, was engaged from November 11 to 21, 1956, in the examination and study of historical horological and business-machine collections in West Chester, Pa., Clifton, N. J., New York City, South Kent, Waterbury, East Hartford, and New London, Conn., and Monson, Crafton, Milton, Waltham, Auburndale, and Boston, Mass. The period from February 19 to 22, 1957, was utilized by Mr. Battison to examine and study the clock, watch, lock, and calculating-machine exhibits and collections located in the offices of manufacturing firms, individuals, and institutions in New London and New Haven, Conn. Mr. Battison visited a number of dealers in New York City in search of old and unusual clocks and watches for the exhibit series on May 2, 1957, and examined many early European watches belonging to the Metropolitan Museum of Art.

Potential donations from the Massachusetts Institute of Technology and Harvard University of electrical equipment were discussed with responsible officials, November 7-10, 1956, by W. James King, associate curator of electricity. He visited the Franklin Institute, Philadelphia, December 11-12, 1956, to examine the technique employed in the display of electrical equipment and studied display techniques utilized for communication apparatus in the Museum of the Signal Corps, U. S. Army, at Fort Monmouth, N. J. He also inspected the technical relics of Edison exhibited in the Edison Laboratory National Monument, West Orange, N. J., as well as displays in the museums of New York City, December 26-31, 1956. He held discussions with individuals familiar with the early history of radio and other electrical devices, February 10-15, 1957, at Norwalk and Stamford, Conn., and at Troy and Schenectady, N. Y. At the Rensselaer Polytechnic Institute, Troy, he reviewed several pieces of laboratory equipment for possible presentation. Consideration was given by the General Electric Research Laboratory, Schenectady, to the transfer of certain outmoded pieces of equipment for the display series. Further consultations with the staffs of the departments of mechanical and electrical engineering of the Massachusetts Institute of Technology on April 17-18,

1957, did not reveal the existence of immediately available electrical power machinery.

At Schenectady, May 14-17, 1957, Mr. King was shown historically interesting vacuum tubes and also received three magnetrons from the General Electric Research Laboratory. Dr. Irving Langmuir and Dr. W. D. Coolidge gave particularly helpful advice. Consultations were held with officials of the physics and electrical engineering departments of Union College regarding possible donations of apparatus. From E. F. Hennelly, he obtained Dr. Albert W. Hull's kenopliotron, the first radio receiver using 60-cycle power only.

Kenneth M. Perry, associate curator of marine transportation, visited, August 20-29, 1956, the Marine Museum of Seaman's Church Institute, New York City; the Marine Historical Society's "Mystic Seaport," Mystic, Conn.; the Russell Hart Nautical Museum, Cambridge; the Penobscot Marine Museum, Searsport, Maine; the Old Dartmouth Historical Society and Jonathan Bourne Whaling Museum, New Bedford; the Whaling Museum of the Nantucket Historical Society; and the hall of marine transportation in the Franklin Institute, Philadelphia. During the period December 17-19 he inspected the watercraft collection of the Mariner's Museum at Newport News, Va.

Leslie J. Newville, engineering division, examined extensive documentary material relating to the development of phonographs in the possession of the Radio Corporation of America at the Camden and Cherry Hill plants, as well as at the Edison Laboratory National Monument, West Orange, N. J., from October 17 to 19, 1956.

Philip W. Bishop, curator of industrial cooperation, studied the principal exhibits in the Franklin Institute relating to the practical applications of science, November 23-24, 1956. At the invitation of the Bethlehem Steel Co., Messrs. Bishop, Woodbury, Battison, and Perry visited, on April 16, 1957, the Sparrows Point Plant in Maryland for a guided tour of the operations of the blast furnace, open hearth shops, Bessemer converters, slab mill, hot and cold continuous strip mills, and the galvanizing and tinning plants. Curator Bishop on April 29, 1957, consulted material in the libraries of the Engineers Societies of New York and the American Society of Civil Engineers to obtain documentary data required for the cataloging of the engineering drawings of Alexander Lyman Holley.

Data and ideas useful in the planning for the graphic arts displays in the projected exhibit halls of the Museum of History and Technology were obtained by Jacob Kainen, curator of graphic arts, on a European trip extending from September 7 to 30, 1956. The museums he visited featured either science and technology or graphic arts, or fine and decorative arts. The exhibits were chiefly technological in Teyler's Museum, Haarlem; Museum for the History of Physical

Sciences, Leiden; Deutsches Museum, Munich; Museo Nazionale della Scienze e della Tecnica, Milan; and Museo di Storia della Scienze, Florence. He studied exhibit techniques for the display of graphic arts in the print rooms of the Rijksmuseum and the Gemeente Museum, Amsterdam; the Print Cabinet of Boymans Museum, Rotterdam; the Plantin-Moretus Museum and Prenten Cabinet, Antwerp; the Cabinet des Estampes, Bibliothèque Royale, Brussels; the Graphische Sammlung, Munich; the Gabinetto dei Disegni e Stampi, Uffizi Gallery, Florence; and the Gabinetto Nazionale della Stampi, Rome. Most of these institutions serve as research centers for scholars. In the museums featuring decorative arts, such as Die Neue Sammlung, Munich, and the Bavarian National Museum, Munich, contemporary display techniques were employed.

Edward C. Kendall, associate curator of manufactures and agricultural industries, on March 9-10, 1957, examined the Laucks collection of farm equipment belonging to the York County Historical Society at Lancaster, Pa., and the Pennsylvania Farm Museum of Landis Valley with a view of locating duplicate equipment suitable for display purposes. An old Pennsylvania plow dating from at least 1807 was presented by Daniel G. H. Leshner of Waynesboro, Pa. Tentative arrangements for obtaining duplicate examples of farm equipment in the possession of the New York State Historical Association at the Farmer's Museum, Cooperstown, were made by Mr. Kendall, March 31-April 3, 1957.

Miss Grace L. Rogers, assistant curator of textiles, studied exhibit techniques and methods of portraying the crafts of primitive man, especially those of spinning and weaving, at the American Museum of Natural History and the exhibit on printing fabrics in the Cooper Union Museum. Effective exhibit techniques were observed in the display of summer and other fabrics at the Salamandré Museum of Textiles and at the Museum of Modern Art, New York City. Methods of cataloging and storage of textiles utilized in the Textile Study Room of the Metropolitan Museum of Art were particularly instructive. This visit extended from August 27 to 31, 1956.

At the County Court House, Savannah, Ga., Miss Rogers searched the circuit court records from 1796 to 1812 for information on the trials pertaining to Eli Whitney and the cotton gin. Valuable assistance was given by Mrs. Hawes of the Georgia Historical Society. Miss Rogers also examined the textile collections of the Telfair Academy of Arts and Science and the Charleston Museum and the facilities for storage of textiles at Colonial Williamsburg, March 11 and 16, 1957, and consulted with Arthur E. Wullschleger, New York City, on April 11-12, 1957, regarding the assembly of an old Jacquard loom that he had purchased in France as a gift to the museum.

George Griffenhagen, curator of medicine and public health, September 8-15, 1956, discussed dental history exhibits, apothecary shop restorations, and pharmaceutical antiques with officials of the Charles H. Land Museum and the Columbia University College of Pharmacy in New York City, the owners of collections in Bridgeport and Newton, Conn., the Beverly Historical Society and the Essex Institute, Salem, Mass., the Albany, N. Y., College of Pharmacy, the Coopers-town Farmer's Museum, the Rochester Museum of Arts and Sciences, and the Buffalo Historical Society. At Jamestown and Colonial Williamsburg on October 30, 1956, he examined early English delft and glass drug containers and devoted December 10-12 to a review of the Ephraim McDowell Medical Museum in Danville, Ky., and to conferences relative to the apothecary shop restoration planned for this museum. He held conferences relating to the Hall of Health with medical historians in New York City, December 26-28, 1956. As executive Secretary of the Fourth Pan American Congress of Pharmacy and Biochemistry, Mr. Griffenhagen undertook a 3-week trip through Latin America, which required stops in Venezuela, Brazil, Peru, Ecuador, Panama, Costa Rica, and Cuba, which afforded an opportunity to examine collections of pharmaceutical antiques in Rio de Janeiro and Lima. He studied ceramic drug jars at the School of Pharmacy Museum, Minneapolis, and the pediatric and medical antiques at the Canadian Academy of the History of Pharmacy, Toronto, April 1-6, 1957.

Mr. Griffenhagen displayed panels to be shown in the new Hall of Health at the meeting of the American Association of Anatomists, Baltimore, April 16-19, 1957. He held consultations relative to the donation of ceramic apothecary jars by the Bristol-Myers Co., the possible participation by Schenley Laboratories in the restoration of "Americana Pharmacy," and the content of the Hall of Dental History with representatives of the American Academy of History of Dentistry, April 30-May 2, 1957, at New York City.

Mendel L. Peterson, acting head curator of history, studied the military collections at the Chapel Museum, Fort Jay, and Castle William on Governors Island, as well as the Cooper Union Museum and the Marine collections of the Seaman's Bank of Savings, New York City. At Boston he visited the Old State House, the Frigate *Constitution*, the Bunker Hill site, Old North Church, and Old South Church. This travel extended from April 15 to 17, 1957.

Franklin R. Bruns, Jr., curator of philately and postal history, consulted donors and potential donors to the national stamp collections at New York City, October 8-9, 1956, at Princeton, N. J., April 19, Detroit, May 1, and Chicago, May 2, 1957.

To observe European museum practices, exhibition techniques, and the content of military collections for the advancement of planning

the displays in the Museum of History and Technology, Edgar M. Howell, acting curator of military history, departed from Washington on May 3, 1957. In the course of this travel he took extensive notes and photographs of military collections at Madrid, Spain; Paris, France; Vienna, Austria; Brussels, Belgium; Amsterdam, The Netherlands; Oslo, Norway; Stockholm, Sweden; Copenhagen, Denmark; London, England; and Edinburgh, Scotland. This detail was completed June 6, 1957.

Dr. V. Clain-Stefanelli, curator of numismatics, November 22-25, 1957, discussed types of display cases, cabinets for study collections of coins, medals, and paper currency, and display methods for numismatics in New York City with officials of the American Numismatic Society, the Money Museum of Chase National Bank, and the Metropolitan Museum of Art. On April 12, 1957, he conferred with Julius Lauth of the Medallie Art Co. relative to a medal exhibit illustrating the manufacturing processes, artists' drawings and models, and engravers' tools, and with Ernest Moore of the Gorham Co. regarding production of coins and medals. Potential donations and transfers were discussed with several numismatists. At Clinton, Conn., William Hasse, Comptroller of the New Haven Bank, presented a number of early New Haven checks and promised help in obtaining notes, plate proofs, and copper currency plates for the national collections. Sources of information regarding Confederate note issues were suggested by Philip Chase of Wynnewood, Pa., May 11, 1957. Mr. Chase decided to present a set of Confederate chemiograph plates.

William L. Brown, chief zoological exhibits specialist, and Norman H. Deaton examined the skeletons of elephants in the collections of the American Museum of Natural History, and living animals at the New York Zoological Park to obtain required measurements and data for the preparation of an unusually large specimen from Angola for exhibition.

EXHIBITIONS

A congressional allotment of \$601,000 permitted continuation in 1957 of the program for modernization of selected exhibition halls. Construction work was completed during August 1956 on the Power Hall, during January 1957 on the American Indian Hall, and during June 1957 on the Health Hall. Construction bids were received for the Gems and Minerals Hall in January 1957, the World of Mammals in May 1957, and the Textile Hall in June 1957. Actual construction was commenced in these halls approximately one month after the bids were approved by the Public Buildings Service.

More than 800 guests were present on the night of January 26, 1957, when Dr. Leonard Carmichael, Secretary of the Smithsonian Institution, and Mrs. Arthur M. Greenwood opened the Hall of Everyday

Life in Early America. Home furnishings, tools, crafts, and arts of early settlers are displayed to illustrate the many elements in the domestic and community life of the period.

Secretary Carmichael and Dr. Melville Bell Grosvenor, President of the National Geographic Society and grandson of Alexander Graham Bell, during the morning of March 11, 1957, invited the visiting public to view the recently completed exhibit produced and presented by the Bell System and the independent telephone industry to illustrate the invention and development of the equipment required for the operation of a modern telephone system.

On March 27, 1957, Dr. Carmichael and Dr. Robert P. Multhauf formally opened the Hall of Power Machinery. In this hall, moving engines and models, murals, diagrams, and schematic mechanisms are displayed to show technological development from primitive wind- and water-powered machines to the steam and gas turbines.

The recently completed Hall of North American Mammals was viewed by a number of guests on April 30, 1957, following a brief ceremony at which the contributions to mammalogical research by the staff of the Institution during the preceding 100 years were reviewed by Dr. Carmichael and Dr. Kellogg. In this hall 12 habitat groups with scenic mural backgrounds present the larger native mammals of major importance to the American pioneer.

During the year seven new exhibit units were completed for installation in the recently constructed North American Indian Hall, in which life-size ethnic groups will depict the everyday activities and the cultures of the Indians of eastern, central, and northern United States, Canada, and Alaska, and of the Eskimo tribes of the Arctic regions. Two Egyptian bull mummies installed in the Hall of Old World Archeology seem to be especially interesting to school children. Temporary revisions have been made in the North American Archeology halls.

Detailed plans for the two halls of the World of Mammals were carried forward by Dr. Henry W. Setzer, associate curator of mammals. Progress was made in the planning for the marine exhibits that will occupy the large central hall of the west wing of the Natural History Building.

A series of dioramas of fossil marine life will be shown in the Hall of Invertebrate Paleontology. Two of the completed dioramas reconstruct the life present on sea bottoms during the Middle Cambrian and Permian time. Construction work on the Gem and Mineral Hall required removal of the materials heretofore exhibited there. A part of the popular gem collection was placed temporarily on exhibition on the first floor near the rotunda. Plans for the Hall of Lower Vertebrates were revised to provide display space for newly acquired mate-

rials. Restoration of a number of fossil fishes and tetrapods has been completed for the exhibit series.

Work began on the renovation of the graphic-arts exhibits illustrating the history and methods of fine printmaking. Arrangements were made with prominent artists for exhibits illustrating the history and methods of printmaking. A number of important prints by some of the earlier artists were acquired for the exhibit series. Exhibits on camera lenses, instantaneous photography, and camera shutters were installed in the refurbished photography gallery. This gallery is also utilized as a photographic-print salon for special exhibitions of the work of present-day photographers.

The new Hall of Health is nearing completion. Plans for the modernized textile hall have been completed. Improvements have been made in the automobile hall. A rearrangement of reconditioned time-keeping instruments has greatly improved the attractiveness of this exhibit.

Work on an exhibit illustrating the history of the United States Army was advanced by the installation of weapons, models, and dioramas. Progress was made on the renovation of the exhibit comprised chiefly of the New England Copp family collections of household furnishings and personal effects. More than 100 exhibition frames of stamps were renovated. Special exhibits comprising old campaign buttons, torchlights, parade costumes, election souvenirs, banners, inaugural medals and inaugural programs were arranged for display at the time of the national elections and the presidential inauguration.

Eight exhibition halls had been completed for viewing by the visiting public at the close of the fourth year of the continuing program for the modernization of the Smithsonian exhibits. Following preparation of the original narrative scripts and selection of objects by the curators, the museum's exhibits designers and preparators, in consultation with the curators involved, design the hall layouts and construct the individual exhibits. As many as 50 topics have been presented in one exhibition hall. That the modernization program has proceeded smoothly and effectively is shown by the encouraging public response to these new exhibits.

The educational program of volunteer docent guide service conducted with the cooperative assistance of the Junior League of Washington for the benefit of the schoolchildren of Greater Washington, was continued with success. The work remains under the immediate supervision of Frank M. Setzler, head curator of the department of anthropology, together with Mrs. Robert Nelson and Mrs. Alexander Chilton, of the Junior League, who helped to organize the program and made the arrangements with the teachers for the docent service.

During the past school term 116 tours were conducted, the docents escorting in all 3,056 children through the exhibit halls of the American Indians and the First Ladies of the White House. Counting those from last year, a grand total of 7,556 children have thus far been escorted. The tours were conducted Monday through Saturday by Mrs. G. E. Brown, Mrs. Alexander Chilton, Mrs. Walter Graves, Mrs. Edward Lamont, Mrs. William McClure, Mrs. Robert McCormick, Mrs. Peter Macdonald, Mrs. John Manfuso, Mrs. Robert Nelson, Mrs. Bolling Powell, Mrs. Jay B. L. Reeves, Mrs. John Schoenfeld, Mrs. E. T. Stirling, Mrs. Richard Wallis, and Mrs. George Wyeth.

The number of schoolchildren thus far accommodated is gratifying, yet it is only a small percentage of the number who come to the Museum from all States of the Union to visit the Museum. The numerous requests for this type of service only accentuate the acute need for an expanded program. The Junior League of Washington is enthusiastic about continuing this volunteer service and intends to expand it next year to include two more exhibition halls that have recently been opened, *Everyday Life in Early America* and the *Power Hall*.

VISITORS

During the fiscal year 1957 there were 4,076,908 visitors to the Museum buildings, an increase of 556,802 over the attendance for 1956. The average daily number of visitors was 11,614. On one day, May 4, 1957, 73,141 visitors were recorded. Attendance records for the three buildings show the following numbers of visitors: Smithsonian Building, 791,663; Arts and Industries Building, 2,125,198; and Natural History Building, 1,160,044. March 1957 was the month of the largest attendance with 623,502 visitors; April 1957 was the next largest with 570,425; and August 1956 was third with 551,394. Included in this total are 370,034 schoolchildren, who arrived in 9,193 separate groups.

BUILDINGS AND EQUIPMENT

The architects of the new building for the Museum of History and Technology completed their studies for the exterior design of the building and submitted diagrammatic plans in accordance with the estimated schedule for their work. The design they favored was voted the preference of the Joint Congressional Committee on Construction of a Building for a Museum of History and Technology for the Smithsonian Institution. The Committee so advised the Regents of the Smithsonian Institution, and the Regents voted unanimously to adopt the preferred design. Upon the completion of the diagrammatic plans, the architects and the Public Buildings Service made

detailed estimates of the cost to construct the building. These estimates disclosed that the building, if built within the appropriation, would be much smaller than the size of the building that had been determined to be required for the needs of the Smithsonian and upon which the original estimates for the appropriation were made. This development was brought to the attention of the Joint Committee and the Board of Regents. The objective was to determine the size of the largest operable building that could be built with the appropriated funds. At the end of the year, the question of determining the basis on which it would be necessary to proceed was under discussion. Planning of the interior of the building by the Smithsonian staff continued during the year. This is described in part under the section on exhibits.

Planning for the additions to the Natural History Building continued throughout the year. A committee of Smithsonian staff members appointed by the Director reviewed the previous planning, assembled the latest data on the requirements of the scientific and service divisions, and studied all the proposals for facilities and equipment in the additions. A thoroughly prepared program of the requirements will be available for the guidance of the architects. Dr. T. Dale Stewart is chairman of the committee. Funds for planning the additions, including the preparation of working drawings and specifications, were appropriated by the Congress at the turn of the fiscal year.

CHANGES IN ORGANIZATION AND STAFF

After nearly 50 years of government service, of which 42 years and 6 months were with the Smithsonian Institution, Dr. Waldo L. Schmitt, head curator of zoology, having reached the mandatory retirement age, was placed on the retired roll on June 30, 1957.

Smith H. Oliver, associate curator of land transportation and horology, resigned July 13, 1956. On July 21, 1956, Dr. Ernest R. Sohns, associate curator of grasses since 1951, transferred to the Department of Defense. Dr. A. C. Smith, curator of phanerogams since 1948, resigned on August 19, 1956, to accept a position with the National Science Foundation. Dr. A. R. Loeblich, Jr., associate curator of invertebrate paleontology, resigned June 28, 1957, to join the research staff of the California Research Corporation.

In the department of zoology, Dr. Ralph E. Crabill, Jr., accepted an appointment as associate curator of insects on September 18, 1956, and William R. Taylor as associate curator of fishes on December 3, 1956.

Dr. Saul H. Riesenbergs on August 7, 1956, was appointed to the associate curator vacancy in ethnology.

The vacancy resulting from the death of Dr. William F. Foshag was filled July 16, 1956, by the promotion of Dr. G. Arthur Cooper to head curator of the department of geology.

In the department of botany, Dr. Lyman B. Smith was promoted to curator of phanerogams effective August 20, 1956, Dr. Richard S. Cowan was appointed associate curator of phanerogams on May 1, 1957, and Dr. Mason E. Hale, Jr., as associate curator of cryptogams on June 17, 1957.

Vacancies in the department of engineering and industries were filled by the appointment of Dr. Robert S. Woodbury as curator of mechanical and civil engineering July 9, 1956, of Edwin A. Battison as associate curator of light machinery July 19, 1956, of Dr. Philip W. Bishop as curator of industrial cooperation October 1, 1956, and of Dr. Derek J. Price as consultant on the history of science, particularly scientific instruments January 7, 1957.

Dr. Philip W. Bishop on May 15, 1957, was designated acting head curator of the department of arts and manufactures as a result of the reorganization of the former department of engineering and industries. Dr. Robert P. Multhauf will serve as head curator of the department of science and technology.

Vacancies in the department of history were filled by the appointment of Edgar M. Howell on September 10, 1956, as acting curator of military history and of Dr. Vladimir Clain-Stefanelli on October 1, 1956, as curator of numismatics. Mrs. Anne W. Murray was reassigned to serve as assistant curator of civil history July 17, 1956. Mendel L. Peterson, acting head curator of the former department of history, became, effective November 13, 1956, head curator of the department of armed forces history. Dr. Brooke Hindle agreed to serve as consultant on the planning for the historical exhibits on March 13, 1957.

Robert Sterling Clark, 79, art leader and sportsman, died December 29, 1956, at Williamstown, Mass. He founded the Sterling and Francine Clark Art Institute, which opened in May 1954 at Williamstown. Clark, a collaborator in zoology since 1922, engaged Arthur de Carle Sowerby in 1909 for a 3-year period to accompany him as naturalist of a scientific and geological expedition into northwestern China, and subsequently financed the latter's collecting expeditions for the next 20 years. The zoological specimens were sent to the National Museum.

Stuart Hoffman Perry, 82, associate in mineralogy since April 1, 1940, died at Tucson, Ariz., February 15, 1957. Mr. Perry, a generous donor of meteorites and fossils to the national collections, received the G. Lawrence Smith medal from the National Academy of Sciences in 1946. He was the author of *United States National Museum Bulletin* 184, "The Metallography of Meteoric Iron."

Dr. Adam G. Böving, 87, associate in zoology since 1939, died at his home in Washington, D. C., on March 16, 1957. Dr. Böving was one of the pioneers and world authorities on beetle larvae. Until his retirement in 1945 he had been employed since 1913 as an entomologist by the U. S. Department of Agriculture.

Robert A. Cushman, 77, assistant custodian of Hymenoptera since 1927, died at Altadena, Calif., on March 27, 1957. Cushman was appointed entomologist in 1906 in the U. S. Department of Agriculture and remained in that organization until he retired for health reasons in 1944. He published many significant articles dealing with the classification of parasitic Hymenoptera.

Respectfully submitted.

REMINGTON KELLOGG, *Director.*

Dr. LEONARD CARMICHAEL,
Secretary, Smithsonian Institution.

Report on the Bureau of American Ethnology

SIR: I have the honor to submit the following report on the field researches, office work, and other operations of the Bureau of American Ethnology during the fiscal year ended June 30, 1957, conducted in accordance with the act of Congress of April 10, 1928, as amended August 22, 1949, which directs the Bureau "to continue independently or in cooperation anthropological researches among the American Indians and the natives of lands under the jurisdiction or protection of the United States and the excavation and preservation of archeologic remains."

SYSTEMATIC RESEARCHES

Dr. M. W. Stirling, Director of the Bureau, spent the period February 4 to May 10 conducting an archeological reconnaissance in Ecuador under the joint auspices of the National Geographic Society and the Smithsonian Institution. Assisting in the work were Mrs. Stirling and Woodbridge Williams, National Geographic Society photographer. During the course of the expedition the party saw all the major archeological collections in the country. They made test excavations at various places on the coast of Esmeraldas and Manabi and during April 3 to April 17 conducted a stratigraphic excavation at Tarqui, near Manta. The cultural deposits reached a depth of 15 feet. Although detailed study of the abundant material recovered remains to be done, the site evidently belongs to the late Formative Period. Other places of interest visited during the reconnaissance were the Island of Santa Clara, the Inca ruin of Ingapirca, and the famous archeological site of La Tolita on the northern coast. On the east side of the Andes several mound groups were discovered on the Pastaza River in the vicinity of Puyo and Shell Mera. The work was accomplished with the permission and cordial cooperation of the Ecuadorean Casa de la Cultura. The expedition is particularly indebted to Carlos Zevallos Menéndez, head of the Casa de la Cultura in Guayaquil, and to Emilio Estrada of Guayaquil for their wholehearted assistance.

Dr. Frank H. H. Roberts, Jr., Associate Director of the Bureau, devoted most of his time to duties pertaining to the management of the River Basin Surveys, of which he is Director (see his report, p. 44). Early in July he made an inspection trip to a field party

working in the Lovewell Reservoir area on White Rock Creek in Kansas, and to parties working in the vicinity of Pierre, S. Dak. He attended and participated in the sessions of the Fifth International Congress for Anthropological and Ethnological Sciences held at Philadelphia, Pa., in September. During the fall and winter months he reviewed and revised a number of manuscript reports on the results of investigations in several areas. In November he visited the field office and laboratory of the River Basin Surveys at Lincoln, Nebr., and presided over one of the sessions of the 14th Conference for Plains Archeology. At the end of April Dr. Roberts went to Lincoln to assist in preparing plans for the coming field season and to take part in a meeting of the Missouri Basin Inter-Agency Committee, which convened there on May 1. From Lincoln he went to Madison, Wis., to attend the annual meeting of the Society of American Archeology and to discuss problems concerning the Inter-Agency Salvage Program with archeologists present there. He returned to Lincoln later in May to confer with members of the field staff on the program for summer fieldwork and attended sessions of the annual meeting of the American Association of Museums being held there. Early in June he visited a field party that was excavating sites in the Toronto Reservoir area on the Verdigris River in southeastern Kansas. At the close of the fiscal year Dr. Roberts was in the office in Washington.

At the beginning of the fiscal year Dr. Henry B. Collins, anthropologist, was in Europe studying museum collections of Mesolithic materials for their possible bearing on the Eskimo problem. The study was supported by a grant from the American Philosophical Society. The need for such a study arose from the fact that recent excavations at early Eskimo and pre-Eskimo sites in Alaska, Canada, and Greenland have revealed a number of implement types similar to those of the Mesolithic and early Neolithic cultures of Eurasia, lending weight to previous indications that Eskimo culture was basically of Mesolithic origin. Prominent among the Arctic sites exhibiting Mesolithic affinities is the early Dorset culture site T 1, on Southampton Island, Hudson Bay, where Dr. Collins excavated in 1954 and 1955.

In London Dr. Collins examined the extensive collection of Mesolithic implements from Europe, Africa, India, and Ceylon in storage at the British Museum (Great Russell Street) as well as the African materials in the British Museum (Natural History), South Kensington. At Cambridge he discussed Mesolithic problems with Dr. J. G. D. Clark and examined the collections, mainly from the early Mesolithic site of Star Carr, in the University Museum. The Tardenoisian and Azilian collections in the Musée de l'Homme, Paris, were made available through the courtesy of the Director, Dr. Henri V. Vallois. At the Bernisches Historisches Museum, Bern, Dr. Hans-Georg Bandi

showed Dr. Collins the materials from a stratified cave near Basel, where Tardenoisian was found overlying the older Sauveterrien, and Dr. R. Wyss showed him materials, now in process of publication, from early Mesolithic sites in the vicinity of Schötz, Canton Luzern. Drs. E. Vogt and Joseph Speck made available the extensive Mesolithic and Neolithic study materials in the Schweizer Landesmuseum, Zürich, and Museum für Urgeschichte, Zug. Other Swiss museums in which similar collections were studied were the Musée d'Art et d'Histoire, Fribourg; Museum Schwab in Biel; Heimatmuseum, Rorschach; Musée d'Art et d'Histoire de Genève; Historisches Museum, St. Gallen; Historisches Museum, Baden; Gletschergarten Museum, Luzern; Musée Archéologique et Historique, Lausanne; and Heimatmuseum, Schötz. The extensive Mesolithic collections from Scandinavia in the National Museum, Copenhagen, were examined during the time Dr. Collins was there as a delegate to the 32d Session of the International Congress of Americanists. At the Museum of Far East Antiquities in Stockholm, through the kindness of Drs. Karlgren and Sommerstrom, he was able to study the rich collection of artifacts from Mesolithic and Neolithic sites in Inner Mongolia obtained by the late Dr. Folke Bergman, archeologist of the Sven Hedin Expedition. The firsthand knowledge of the Mesolithic materials from Eurasia gained from the museum survey will make possible a more precise evaluation of the relationship between the Old World Mesolithic and the early Eskimo and pre-Eskimo cultures of the American Arctic. The results will be incorporated in reports describing and interpreting the Arctic materials, including those excavated on Southampton Island in 1954 and 1955.

Preliminary reports on the early Dorset materials from Southampton Island have been published in the Annual Report of the National Museum of Canada and in Anthropological Papers of the University of Alaska. A popular article on the work was published in the National Geographic Magazine for November 1956, and a general article on the same subject appeared in the Smithsonian Annual Report for 1956. An article on Eskimo archeology was prepared for the next edition of the Encyclopaedia Britannica. Dr. Collins continued to serve as chairman of the directing committee of *Arctic Bibliography*, an annotated and indexed bibliography of Arctic publications in all fields of science, which is being prepared for the Department of Defense by the Arctic Institute of North America. Volume 7 of the *Bibliography* was issued by the Government Printing Office in June 1956, and the material for volume 8 will be turned over to the printer in July.

Dr. William C. Sturtevant, ethnologist, divided his time principally between continuing his studies of the Florida Seminole (begun before joining the Bureau) and initiating new studies among the Seneca.

During the year he continued analysis and organization of his Seminole field notes and conducted research on printed, manuscript, and photographic materials relating to the Seminole in library and archival repositories in Washington and in the library of the American Philosophical Society in Philadelphia. He continued the work of revising for publication a manuscript on Seminole medicine and magic, and prepared for fieldwork in Florida during the next fiscal year. He nearly completed during the year a long paper on the supposed ethnological resemblances between the southeastern United States and the West Indies. His short Seminole autobiography, collected in 1950 and 1952, appeared in the journal *Tequesta*, this being the first such document published for any tribe of the southeastern United States. At the end of January and the beginning of February, Dr. Sturtevant spent a week in south Florida, where he delivered a public lecture on "The Indians of South Florida" before the Historical Association of South Florida and read a paper on "Accomplishments and Opportunities in Florida Indian Ethnology" at the annual meetings of the Florida Anthropological Society. This trip enabled Dr. Sturtevant to revisit several Seminole settlements, securing some new ethnological data.

Another project involved library research on the history and use of some root foods of the southeastern United States and the West Indies—chiefly the cycad *Zamia* and manioc. A monograph on the subject is in preparation, and future fieldwork concentrating on the same topic is planned for Cuba and perhaps elsewhere. New evidence has been discovered here relating to supposed prehistoric contacts between the two regions and to continuity in each area between aboriginal and European practices with regard to root foods, and on changes and borrowings during the historic period.

Dr. Sturtevant's Seneca work concentrated on the use and manufacture of wooden masks, and especially on the esthetic attitudes of the modern Seneca toward these masks. Trips were made to examine museum collections and consult specialists in Philadelphia, New York, New Haven, Albany, and Rochester. Dr. Sturtevant spent May and June doing fieldwork on the Cattaraugus Seneca reservation in western New York State, with briefer trips to the nearby Allegany Seneca reservation. No intensive ethnological work has been done on the Cattaraugus reservation for some 40 years, in marked contrast to the situation with other Seneca communities. The fieldwork enabled the documentation of differences between the Cattaraugus Seneca and other Seneca already described in the literature, especially in the ceremonial cycle of the non-Christian groups. Considerable information was collected on present-day usages and beliefs connected with the masks. Texts of myths, religious speeches, prayers, and songs

related to them were recorded in Seneca and transcribed and translated. Case histories of individuals cured by use of the masks were also gathered and analyzed. The esthetic attitudes of the Seneca toward the masks are difficult to distinguish from their feelings about their religious associations and ceremonial and curative powers, but through the use of photographs of museum specimens and the examination with informants of specimens in use in the community and a collection in the Buffalo Museum of Science, some data on this topic were obtained. Another subject on which investigations were begun at both Cattaraugus and Allegany is an interesting pattern of ritual friendship, by which two or more individuals go through a ceremony for curative or other reasons, which puts them in a siblinglike relationship and results in the extension of the appropriate kinship terms and some aspects of kinship behavior to other members of their families. This is a form of fictional kinship which has interesting parallels in many other societies; godparenthood and blood-brotherhood are related phenomena, for example.

Dr. Sturtevant also attended the Fifth International Congress of Anthropological and Ethnological Sciences, in Philadelphia, September 1-9, and the Tenth Conference on Iroquois Research, Red House, N. Y., October 26-28.

On May 8, 1957, Carl Miller was temporarily transferred from the River Basin Surveys to the rolls of the Bureau of American Ethnology for the period ending September 1, in order that he might continue the excavations begun last year at Russell Cave, Alabama, where very early Indian remains were found in stratigraphic sequence. He spent May and June at Russell Cave opening a new trench and making preparations for converting the excavation into a permanent exhibit.

RIVER BASIN SURVEYS

(Prepared by FRANK H. H. ROBERTS, JR., Director, from data submitted by staff members)

The River Basin Surveys, a unit of the Bureau of American Ethnology, continued its program for salvage archeology throughout the fiscal year. The investigations were carried on in cooperation with the National Park Service and the Bureau of Reclamation of the Department of the Interior, the Corps of Engineers of the Department of the Army, and several State and local institutions. Because of an increase in funds more activities were possible than in the preceding year. During fiscal 1956-57 the work of the River Basin Surveys was supported by a transfer of \$108,500 from the National Park Service to the Smithsonian Institution. Of that sum \$90,000 was for use in the Missouri Basin and \$18,500 for work in other drainage areas. This was the first time in several years that Federal money was available for studies by the River Basin Surveys at projects outside the Missouri Basin. A

grant of \$12,000 from the Idaho Power Co., made late in the spring of 1956 for archeological investigations along the Snake River in Idaho-Oregon in the districts to be flooded by the Brownlee, Oxbow, and Hells Canyon dams, was available for the field season beginning July 1, and that, with the new Federal money, gave a total of \$30,500 for several reservoir basins in scattered portions of the country. The Missouri Basin Project had a carryover of \$24,954 on July 1 and that, with the new appropriation, provided a total of \$114,954 for work in that area. The grand total of funds available for the River Basin Surveys for 1956-57 was \$145,454.

Field investigations during the year consisted of both surveys and excavations, although the major efforts were directed to the excavation of sites. On July 1, 1956, six parties were in the field—five engaged in digging, the sixth doing preliminary survey and testing. Three of the excavating parties were working in the Oahe Reservoir area in South Dakota, one was in the Lovewell Reservoir area in Kansas, and one was opening sites along the Snake River near Robinette, Oreg. The survey-testing party was devoting its entire attention to the Big Bend Reservoir area in South Dakota. Shortly after the first of July another party proceeded to a large site in the Oahe Reservoir area, also in South Dakota, and began a program of mapping and testing at the remains of the largest known earth-lodge village on the upper Missouri River. All these parties remained in the field until September. Late in August a party proceeded to the Coralville Reservoir on the Iowa River in Iowa and carried on a series of excavations in five sites, working until mid-October. A survey-testing party worked in the Toronto Reservoir area in Kansas from September 22 to October 28. Late in October excavations were started at a large mound in the Hartwell Reservoir area on the Savannah River in Georgia. They were continued until March, when the study of the mound was completed. During March and April a preliminary survey was made of the Dardanelle Reservoir area on the Arkansas River in Arkansas. During April another party made a preliminary survey of the Warrior Lock and Dam on the Black Warrior River in Alabama. On May 15 an excavating party proceeded to the Toronto Reservoir on the Verdigris River in Kansas, and on June 29 it completed the investigations in that area. Early in June four excavating parties started digging at sites in the Oahe Reservoir area in South Dakota and were continuing their investigations at the end of the fiscal year. At the same time an additional four field parties moved into the Big Bend Reservoir basin in South Dakota and began excavating sites in that area. They were continuing their operations at the end of the year. Late in June a survey-testing party moved to the Big Bend area and was just beginning its work on June 29. During the fiscal year nine

parties from cooperating institutions also conducted excavations in the Missouri Basin. Six of them worked in the Oahe Reservoir area, one in the Glendo Reservoir area in Wyoming, one at the Tuttle Creek Reservoir in Kansas, and one at the Pomme de Terre Reservoir in Missouri. Three of the parties completed their projects during the field season of 1956 and the remaining six were continuing their 1957 programs at the end of the fiscal year.

By June 30, 1956, reservoir areas where archeological surveys had been made or excavations carried on since the start of actual fieldwork by the River Basin Surveys in the summer of 1946 totaled 247 in 28 States. In addition, two lock projects and four canal areas had also been examined. As a result of the surveys 4,622 sites had been located and recorded, and of that number 935 have been recommended for examination or limited testing. In using the term "excavation," the complete uncovering of a site is not indicated. Rather it implies digging only about 10 percent of the site. Though many of the locations are of sufficient significance to warrant complete excavation, the needs of the Salvage Program are such that it is not possible to make so extensive an investigation at any one location. Preliminary appraisal reports have been completed for all the reservoir areas surveyed with the exception of one that was done late in the year, and that report is well under way. During the course of the year two such reports were completed and at the end of the year were being mimeographed for distribution to the agencies cooperating in the Inter-Agency Archeological Salvage Program. Since the start of the program 183 such reports have been distributed. In several cases information obtained from a number of reservoir projects falling within a single basin or subbasin have been combined in a single report, and for that reason there is a considerable difference between the number of reservoirs surveyed and that of the reports issued.

At the end of the fiscal year 350 sites in 47 reservoir basins located in 18 different States had been either partially or extensively dug. In some of the reservoir areas only a single site was excavated, while in others a whole series was studied. At least one example of each type of site recorded by the preliminary surveys had been investigated. In the case of some of the larger and more complex types of village remains, it has been necessary to dig a number of somewhat similar sites in order to obtain full information concerning that phase of aboriginal culture. Reports on the results obtained in certain of the excavations have appeared in the Smithsonian Miscellaneous Collections, in *Bulletins of the Bureau of American Ethnology*, and in various scientific journals. During the year River Basin Surveys Papers 9-14, which are to be Bulletin 169 of the Bureau of American Ethnology, were sent to the printer. The six papers consist of three pertaining to investigations in the Missouri

Basin, one to a site in the Allatoona Reservoir area in Georgia, and two to the Jim Woodruff Reservoir area, Georgia-Florida. Three detailed technical reports on the results of earlier work were completed during the year and are ready to submit to the editors for publication.

The distribution of the reservoir projects that have been surveyed for archeological remains was as follows on June 30, 1957: Alabama, 2; Arkansas, 1; California, 20; Colorado, 24; Georgia, 5; Idaho, 11; Illinois, 2; Kansas, 10; Kentucky, 2; Louisiana, 2; Minnesota, 1; Mississippi, 1; Montana, 15; Nebraska, 28; New Mexico, 1; North Dakota, 13; Ohio, 2; Oklahoma, 7; Oregon, 27; Pennsylvania, 2; South Dakota, 10; Tennessee, 4; Texas, 19; Virginia, 2; Washington, 11; West Virginia, 2; and Wyoming, 22.

Excavations have been made or were under way in reservoir basins in California, 5; Colorado, 1; Georgia, 5; Kansas, 5; Montana, 1; Nebraska, 1; New Mexico, 1; North Dakota, 4; Oklahoma, 2; Oregon, 4; South Carolina, 1; South Dakota, 4; Texas, 7; Virginia, 1; Washington, 4; West Virginia, 1; and Wyoming, 2. Only the work of the River Basin Surveys or that which was in direct cooperation between the Surveys and local institutions is included in the preceding figures. Investigations carried on under agreements between the National Park Service and State and local institutions have not been included because complete information about them is not available.

As in previous years, helpful cooperation in carrying on the River Basin Surveys program was received from the National Park Service, the Bureau of Reclamation, the Corps of Engineers, and various State and local institutions. The Corps of Engineers provided transportation and guides for the work in two reservoir areas. Temporary headquarters and living accommodations were made available at several projects. The construction agency in several instances made mechanical equipment available to assist in heavy excavations. The University of Washington at Seattle provided a base of operations and laboratory space for the Snake River party, while the University of Georgia furnished similar accommodations for the party working at the Hartwell Reservoir in Georgia. The field personnel of all the agencies was particularly helpful to the party leaders from the River Basin Surveys and expedited their activities in numerous ways. The National Park Service continued to serve as the liaison between the various agencies both in Washington and in the field. It also prepared the estimates and justifications needed to procure funds to support the Salvage Program. Throughout all the Park Service regions the regional directors and members of their staffs cooperated whole-heartedly in the program.

The main office in Washington continued general supervision of the program, while the field headquarters and laboratory at Lincoln,

Nebr., were responsible for the activities in the Missouri Basin and in addition provided the base of operations for several of the parties working in adjacent areas. The materials collected by excavating parties in the Missouri Basin as well as those from the Snake River and reservoir areas in southeastern Kansas and in Arkansas were processed at the Lincoln laboratory.

Washington office.—The main headquarters of the River Basin Surveys continued throughout the year under the direction of Dr. Frank H. H. Roberts, Jr. Carl F. Miller, archeologist, was based at that office and from time to time assisted the Director in some of the general administrative problems. In October Joseph R. Caldwell was appointed as temporary archeologist to carry on the project at the Hartwell Reservoir in Georgia, with field headquarters at the University of Georgia in Athens. His work was completed and his appointment terminated on April 6, 1957. Dr. Robert E. Greengo joined the staff as an archeologist on a temporary appointment March 6 for the purpose of making the preliminary survey at the Dardanelle Reservoir project in Arkansas. Dr. Greengo proceeded from Washington to Lincoln, Nebr., where he obtained the necessary equipment for his fieldwork and went from there to Arkansas. The general administration of his field investigation was from the Lincoln office. Upon the completion of the survey, Dr. Greengo returned to Lincoln where he prepared his report. He subsequently returned to Washington, and his employment was terminated on May 4. From the beginning of the fiscal year until the latter part of August William M. Bass served as a temporary physical anthropologist studying the skeletal material collected by various parties in the Missouri Basin. He returned to duty on June 3 and resumed his work on the bones. He was occupied with that task at the end of the fiscal year. Although technically a member of the staff of the Washington office, Dr. James H. Howard, archeologist, reported to the Lincoln office on May 13 and worked under its supervision in the Toronto Reservoir area in Kansas. His work there was completed by the end of the year, and it was contemplated that he would be shifted to the Missouri Basin Project. Dr. Warren W. Caldwell, who was in charge of the Snake River field party at the beginning of the fiscal year, was shifted by the Washington office to the Missouri Basin Project in August. His place for the remainder of the field season was taken by George L. Coale, who served as a temporary archeologist until December 15. After being appointed a member of the regular Missouri Basin staff, Dr. Caldwell was detailed to the Coralville project in Iowa for the period from August 28 to October 13. He subsequently returned to the Lincoln headquarters, and all his later activities were in connection with the Missouri Basin Project.

At the beginning of the fiscal year Mr. Miller was in charge of an excavating party in the Oahe Reservoir area, and his activities there are described in the section of this report pertaining to the Missouri Basin. After he returned to Washington in September, he prepared a brief report on the results of the work in South Dakota and then resumed writing on his unfinished report concerning investigations previously made at the John H. Kerr (Buggs Island) Reservoir, Va. In January he selected material from the collections made at the Clark Hill Reservoir in Georgia and prepared an exhibit to be sent to the office of the Corps of Engineers at the Clark Hill Dam in Georgia. During the fall and winter months Mr. Miller gave talks before a number of societies and school groups in the Washington area about the work that he had done at Russell Cave in Alabama while on detail to the regular Bureau of American Ethnology staff in the closing months of the previous fiscal year. Early in April he left for the Warrior Lock and Dam Project area on the Black Warrior River in Alabama and proceeded to carry on a preliminary survey to determine if archeological materials would be involved in the construction at that locality. He completed the survey on April 26, reporting that no significant materials would be lost as a result of that project. On April 27 Mr. Miller proceeded to Little Rock, Ark., for the purpose of making a preliminary survey of the Greers Ferry Reservoir area, but because of heavy rains and exceptionally high water in the area it was necessary to postpone that investigation indefinitely. From Little Rock he went to South Pittsburg, Tenn., to resume work at Russell Cave. On May 6 he was again transferred from the River Basin Surveys staff to the Bureau of American Ethnology for the period of the Russell Cave investigation and at the end of the fiscal year was still in that status. During the month of May Mr. Miller gave talks on his work at Oak Ridge, Tenn., and at Birmingham, Ala. In June he participated in a special televised educational program and spoke before several societies in Tennessee and Alabama.

Alabama.—A survey of the Warrior Lock and Dam Project was made during April. No sites of importance were found in the area to be flooded. However, a number of significant sites which merit study under other than salvage auspices were discovered adjacent to the pool area.

Arkansas.—From March 14 to April 20 a preliminary survey was made of the Dardanelle Reservoir area on the Arkansas River. Fifty-two sites were located and recorded and limited testing was recommended for 23 of them. A preliminary appraisal report was completed in May. A proposed survey of the Greers Ferry Reservoir area had to be postponed because of high waters.

Georgia.—During the period October 25, 1956, to March 23, 1957, in the Hartwell Reservoir area on the Savannah River, a large mound

was excavated at the site of the lower Cherokee town of Tugalo near Toccoa. There are several historical references to the location dating back to about 1715. The village area at the site had previously been explored, but the mound had not been touched. The mound excavations uncovered four superimposed pottery dumps representing a clear continuity from historic Cherokee well back into prehistoric Cherokee. This represents the first known sequence within prehistoric Cherokee materials. Below the Cherokee deposits with a break in continuity was a burned mound and a sequence extending backward through four stages to the beginning of the mound construction. The remains of earth-lodge temples were found on three of the levels and the traces of another type structure were uncovered on the fourth or lowest level. The latter rested on deposits indicating another break in continuity beneath which there was evidence of occupation by a group that has been called Late Middle Creek culture which is believed to date about A. D. 500. The ceramic material obtained from the excavations provides one of the longest pottery sequences ever found in the Georgia area. The work at the Tugalo Mound was a cooperative project in that labor for the digging was provided by the Georgia Historical Commission and a vehicle for transportation and equipment needed in the investigations was supplied by the Department of Anthropology of the University of Georgia.

Iowa.—During the period August 28 to October 13 an excavating party from the River Basin Surveys working in the Coralville Reservoir area completely excavated one rock shelter and tested two others. Three open occupation sites were dug and three others tested. Two mounds were also excavated. The materials obtained demonstrate that the peoples living there had a basic Woodland Culture with some later Mississippi traits. The relationship was predominantly toward the East, but some influences from the Plains were in evidence.

Kansas.—During September and October a survey-testing party operated in the Toronto Reservoir area on the Verdigris River in southeastern Kansas. As a result of its investigations, seven sites were recommended for partial excavation or testing. On May 15 an excavating party proceeded to the area and by the end of the fiscal year had dug in eight sites, one of which was found by the excavating party and had not previously been reported. Six of the sites studied were occupation areas in the open and the other two were rock shelters. The materials obtained there indicate several cultural relationships. There is evidence for Upper Republican, Keith-Focus Woodland, Archaic, and Kansas City Hopewell. The full significance of the information and specimens obtained will not be apparent until detailed studies have been made in the laboratory. No additional work will be required at the Toronto Reservoir.

Missouri Basin.—The Missouri Basin Project continued to operate throughout the year from the field headquarters and laboratory at 1517 O Street, Lincoln, Nebr. Dr. Robert L. Stephenson served as chief of the project throughout the year. Activities included work on all four phases of the Salvage Program: (1) Survey, (2) excavation, (3) analysis, and (4) reporting. The first two phases were emphasized through the summer months and the second two during fall and winter.

At the beginning of the fiscal year the staff, in addition to the chief, consisted of two permanent archeologists, two archeologists detailed to the project from the Washington office, three temporary field assistants, one field and laboratory assistant, one administrative assistant, one museum aide, one photographer, one clerk-stenographer, and one half-time records clerk. There were 28 temporary laborers in the employ of the field parties. At the end of the 1956 field season all temporary employees, with the exception of one field assistant and a survey party chief, were terminated. The men detailed to the project for the season returned to their regular duties in Washington in September, and the temporary field assistant and survey party chief were terminated in January. During the year two permanent archeologists were added to the staff and four temporary archeologists were employed for the 1957 field season. In June one archeologist and one field assistant were again detailed from Washington for work in the field. At the Lincoln office one clerk-typist, one part-time draftsman, one laboratory assistant, and one part-time laboratory assistant were appointed. At the end of the year there were 76 temporary laborers employed by the field parties.

During the year 16 River Basin Surveys field parties were active within the Missouri Basin, while 4 others working in reservoirs outside the Basin also operated from the Project office in Lincoln. Of the 16 Missouri Basin parties, 1 was at work in July, August, and September in the Big Bend Reservoir area, South Dakota, and 5 parties were at work there in June. One party was at work in the Fort Randall Reservoir for a brief time in September. Four parties worked in the Oahe Reservoir in July and August and four other parties were there in June; one field party conducted excavations in the Lovewell Reservoir in Kansas in July and August. The four parties operating outside the Missouri Basin were concerned with the Coralville Reservoir in Iowa, the Toronto Reservoir in Kansas, and the Dardanelle Reservoir in Arkansas.

Other fieldwork in the Missouri Basin during the year included nine field parties from State institutions working under agreements with the National Park Service and in cooperation with the Smithsonian Institution. Parties from the Universities of South Dakota and Wisconsin and from the North Dakota State Historical Society

were in the field in the July–October period. Parties from the Universities of South Dakota, Idaho, Kansas, Missouri, Wyoming, and the State Historical Society of North Dakota were in the field in the May–June period.

A River Basin Surveys party, directed by Robert W. Neuman, was in the field at the beginning of the fiscal year and completed 10 weeks of excavation in four sites along White Rock Creek in the Lovewell Reservoir area in Jewell County, Kans. Three of the sites were fairly extensive but did not yield much material. The artifacts found suggest that they may belong to the White Rock Aspect. The latter is so poorly known that the evidence recovered from them should, even though scanty, clarify the picture greatly. The fourth site was a moderate-sized burial mound of the "Middle Woodland" period. Unfortunately it had been partially destroyed in earlier years by pot-hunting activity. The profile and structure of the mound were, however, readily discernible, and enough material was recovered to identify readily its cultural relationship. Fragments of human and other bones were recovered along with cord-marked potsherds and other artifacts, including two small shell gorgets. No further work is anticipated for the area to be flooded by the waters of the Lovewell Reservoir.

On September 21 and 22 further investigations were made immediately adjacent to the Oldham Site in the Fort Randall Reservoir in South Dakota in an area in which burials and artifacts had been exposed by wave action and lowering of the reservoir. This site had been partially excavated in previous years, and it was hoped that the recent return there would produce additional important evidence. Furthermore there was an opportunity to determine whether a site once flooded could yield worthwhile archeological information if the water receded and left it exposed. Unfortunately, this work produced no new evidence concerning the occupations of the site, even though some artifacts were collected. The ground, though 10 feet above the water level, was too saturated and disturbed to provide any useful information about relationships to the house features, village, or other previously collected material. The work demonstrated conclusively that sites must be dug before they are flooded.

A survey-testing party, directed by Harold A. Huscher, at the beginning of the fiscal year was conducting an intensive survey of the Big Bend Reservoir area, which is situated between the upper reaches of the Fort Randall Reservoir and the Oahe Dam, on the Missouri River, in central South Dakota. The party of three was in the field for 15 weeks and located, visited, and recorded 129 new archeological sites and revisited 26 previously known. Detailed field maps were made of approximately one-quarter of these sites and about one-third of them were tested. Many of them are large and productive and

material from them should fill in some of the gaps in present knowledge of the prehistory of the area, particularly for the period from about A. D. 1000 to 1700.

Several military and trading posts pertaining to the early 19th century were also located in the area. Of particular interest is a site that may belong to the period of the Spanish-Colonial post of Regis Loisel (ca. 1802-03). Several interesting prehistoric sites appear to have had rectangular earth lodges arranged in rows, much the same as at the Huff site in North Dakota. Among other significant manifestations are a boulder effigy site, "Middle Woodland" sites, and sites that appear to be nonceramic.

At the beginning of the 1957 field season in mid-June, there were five field parties in the Big Bend Reservoir area. G. Hubert Smith and a party of nine were at work at the end of the fiscal year excavating the 19th-century historic trading post of white origin known as Fort Defiance (or alternatively Fort Bouis). This same party anticipates investigations at two other 19th-century historic sites in the area when it has completed the season's work at Fort Defiance-Bouis. Dr. Warren W. Caldwell and a party of nine at the end of the fiscal year were excavating the remains of an earth-lodge village which appears to have had three occupations, including a Middle Woodland component. Robert W. Neuman and a party of 10 were excavating a series of three linked earth-lodge village sites on the left bank of the Missouri River in the vicinity of Old Fort Thompson. William N. Irving and a party of nine were also working on the left bank of the Missouri River in the vicinity of Old Fort Thompson. They were starting test excavations in a series of 14 sites and will make a map of each village pattern. Harold A. Huscher and a party of two were preparing to start reconnaissance and mapping of sites and scouting for new sites in the entire area of the Big Bend Reservoir at the end of the fiscal year. None of the five parties had been in the field long enough by the end of the fiscal year to provide specific reports of results.

A River Basin Surveys party, directed by G. Hubert Smith, was in the field in the Oahe Reservoir area at the beginning of the fiscal year and completed nine weeks of excavation at a late historic trading-post site near the Oahe Dam on July 31. This party excavated the stockade outline and the remnants of several interior structures, and recovered a considerable amount of object material representing the period about 1860. The site is believed to be that of Fort Pierre II, which was occupied after the abandonment of Fort Pierre I in 1858. Structural remains were found but a few inches below the plow zone, and in some instances much had been destroyed by plowing over the years. A road patrol was used for clearing away the overburden and very satisfactorily exposed the stockade and other structural features. The stockade proved to be approximately 220 feet square. Other struc-

tural features included a warehouse, a cellar, and a dwelling. Among the objects recovered were two coins dated 1857, glass beads, a religious medallion, several small catlinite balls, and a great mass of hand-wrought iron. No further work is contemplated at that site.

A second River Basin Surveys party in the Oahe Reservoir area, directed by Dr. Waldo R. Wedel, was in the field at the beginning of the fiscal year and completed 12 weeks of digging on August 25. This party was continuing excavations begun in previous years at the Cheyenne River site at the mouth of the Cheyenne River. Three definite occupations of the site were identified. The earliest was a rectangular-house component. The middle one was a circular-house component, and the final occupation was protohistoric Arikara, with circular houses. An encircling stockade and defensive ditch were discovered and excavated, but the specific occupation to which it belonged was not definitely determined. It presumably belonged to one of the two early occupations. A large burial area was excavated and the remains of over 50 individuals were recovered. The burials, in small pits placed close together, were flexed and in most cases had been covered with poles or wooden slabs. The burials almost certainly were from the Arikara occupation. Some artifacts, including pottery and a fine catlinite pipe, were recovered from the graves. The 1956 season's excavations at the Cheyenne River site completed the investigations planned for that location.

A third River Basin Surveys party in the Oahe Reservoir area, directed by Carl F. Miller, was in the field at the beginning of the fiscal year and completed 9 weeks of digging on August 24. This party of nine began, and brought to satisfactory completion, the excavation of the Hosterman site on the Missouri River near Whitlocks Crossing, S. Dak. At that site evidence was found of a stockade consisting of a double row of posts. Several refuse pits, cache pits, and other similar features were excavated, including pits containing large sections of articulated bison bones. The latter appear to have been slaughtering areas. House structures presented a difficult problem as post holes were dim and difficult to identify. One structure was fairly clear in its outline, but the entrance was not located. Artifacts were moderately abundant and suggest that a single occupation, perhaps of short duration, will be established for the site when analysis of the material has been completed. No further work is contemplated at that location.

The fourth River Basin Surveys party in the Oahe Reservoir area, directed by Dr. Robert L. Stephenson, began work on July 2 and completed 6 weeks in the field on August 10. This party of 10 conducted a testing operation at the Sully site some 20 miles above Pierre on the left bank of the Missouri River. The site is that of the largest known



1. Excavating in rock shelter in the Coralville Reservoir area.



2. Tracing the locations of buildings and the stockade at the site of Fort Pierre II.

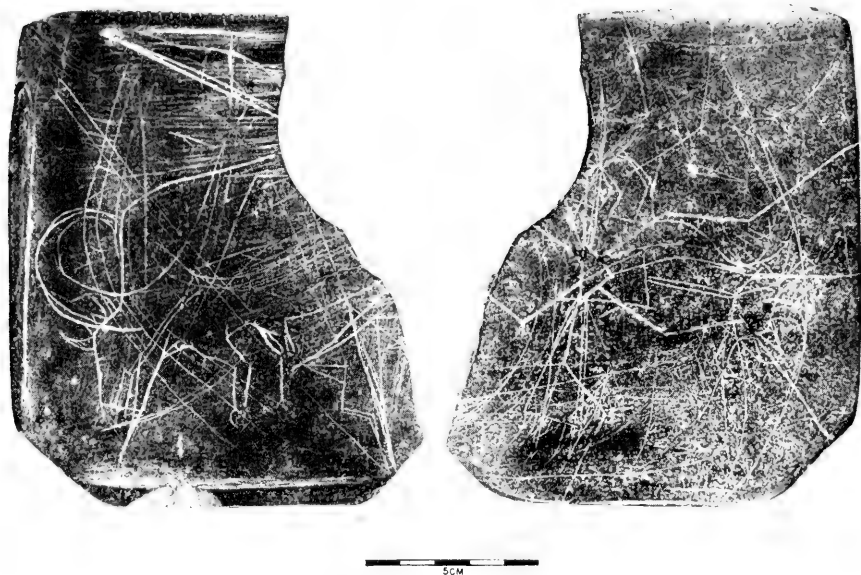

1. Two sides of catlinite plaque with engraved decorations. The plaque was found in the bottom of a cache pit at the Sully site, in the Oahe Reservoir area, near Pierre, S. Dak.



2. Portion of burial area at the Cheyenne village site.

earth-lodge village on the river, and two objectives were accomplished during the season. First, a detailed map was made of the area and the site itself was staked off in 100-foot blocks. Second, a 5-foot-square test was excavated at each 100-foot stake along the north, south, east, and west base lines. In addition, two test trenches were dug and a house quadrant was excavated. The testing procedure was to obtain both horizontal and vertical distribution patterns of specimens and features over the entire site. From the analysis of such distributions, it was possible to plan for the recovery of a maximum amount of information about the site as a whole from a minimum amount of excavation in the 1957 season. The site is nearly 4,000 feet long and 1,500 feet wide and may contain the remains of as many as 400 house structures. More than half that number are identifiable on the surface as unquestionable structures, and an almost equal number appear as possible house structures. They range from 25 feet to over 60 feet in diameter. What were probably four ceremonial lodges are each almost 90 feet in diameter. There is clear stratigraphy in the site, with structures underlying a sterile zone, which in turn underlies a refuse heap. Cache pits are abundant and range from small pocket caches to large bell-shaped pits 7 feet deep and of equal diameter. Artifact material is abundant, and pottery sherds found there suggest at least three, and probably four, occupations. An outstanding specimen, a catlinite plaque with animal designs engraved on both sides, was found in one cache pit. Two certain burial areas, possibly several others, were located but not tested. No fortification ditch or stockade was observed.

Cooperating institutions in the Oahe Reservoir area at the beginning of the fiscal year included a party from the University of South Dakota directed by Roscoe Wilmeth, a party from the University of Wisconsin directed by Dr. David A. Baerreis, and a party from the State Historical Society of North Dakota directed by Alan R. Woolworth.

At the start of the 1957 field season in mid-June, there were four River Basin Surveys parties in the Oahe Reservoir area. Dr. Waldo R. Wedel, again detailed to the project by the United States National Museum, and a party of 10 were excavating the Black Widow site and testing six others nearby in the Fort Bennett area on the right bank of the Missouri River. The Black Widow site was sampled in 1952 by a River Basin Surveys party. Since the material from it suggested affiliations with the site completed by Dr. Wedel in 1956, an extensive excavation was deemed advisable. The adjacent sites to be tested during the 1957 season seem to be a part of the same complex. Donald D. Hartle and a party of eight were making test excavations in a series of 30 sites on the right bank of the Missouri River in the Fort Bennett

area at the end of the fiscal year. A house or two and several cache pits will be dug in each, and a map made of each village plan and site location. Dr. Robert L. Stephenson and a party of 25 were at work at the end of the fiscal year at the Sully site where preliminary studies were made the previous season. The major effort will be the excavation of that site, but seven other small nearby sites that may be related to it will be tested. Charles H. McNutt and a party of eight were making test excavations at 14 sites on the left bank of the Missouri River in the general vicinity of Old Fort Sully. They were excavating a house or two and several cache pits in each and making a map of the village plan and site location. None of these parties had been in the field long enough, at the end of the fiscal year, to report any specific results.

In May and June Dr. Theodore E. White, National Park Service geologist at Dinosaur National Monument, was detailed to the Missouri Basin Project for a period of 6 weeks. During that time Dr. White made an osteological analysis, in the Missouri Basin Project laboratory, of all of the unworked animal bones from the sites excavated over the past four field seasons by the Smithsonian Institution's River Basin Surveys field parties. Work was also done on bones collected by field parties of several of the cooperating institutions. This included over 300,000 individual bones from 63 archeological sites in eight reservoir areas. Dr. White selected numerous specimens for the Missouri Basin Project's comparative collection and set aside others that will be sent to the United States National Museum for further study or for exhibit purposes. The bulk of the identified bone materials remaining was transferred to the Nebraska State Museum. Dr. White amassed voluminous notes on this bone material for use in continuing his series of reports on "Butchering Techniques of Aboriginal Peoples." Material was gathered for at least eight additional papers in this series. Seven have already been published. One of the particularly interesting results of this osteological analysis was the identification of the remains of a number of unusually large dogs in the canid material.

During the time the archeologists were not in the field, they were engaged in analyses of their materials and in laboratory and library research. They also prepared manuscripts of technical scientific reports and wrote articles and papers of a more popular nature. The laboratory and office staff devoted its time to processing specimen materials for study, photographing specimens, preparing specimen records, and typing and filing records and manuscript materials. The accomplishments of the laboratory and office staff are listed in the following tables.

TABLE 1.—*Specimens processed July 1, 1956, through June 30, 1957*

| Reservoir | Number of sites | Catalog numbers assigned | Number of specimens processed |
|--|-----------------|--------------------------|-------------------------------|
| Big Bend..... | 114 | 3, 336 | 24, 602 |
| Coralville..... | 9 | 878 | 3, 088 |
| Dardanelle..... | 51 | 1, 191 | 1, 384 |
| Fort Randall..... | 5 | 157 | 2, 004 |
| Gavins Point..... | 3 | 10 | 11 |
| Lowell..... | 8 | 2, 198 | 5, 689 |
| Oahe..... | 20 | 9, 303 | 140, 630 |
| Toronto..... | 35 | 536 | 862 |
| Sites not in reservoirs..... | 5 | 81 | 679 |
| | 250 | 17, 690 | 178, 949 |
| Collections not assigned site numbers..... | 4 | 23 | 57 |
| | | 17, 713 | 179, 006 |

As of June 30, 1957, the Missouri Basin Project had cataloged 749,244 specimens from 1,725 numbered sites and 50 collections not assigned site numbers.

Additional specimen transfers were made, all to the United States National Museum, as follows: Human skeletal remains from 3 sites in the Oahe Reservoir area; bird bone from 23 sites in 5 reservoirs; fish bone from 9 sites in 3 reservoirs; and unworked shell from 2 sites in 2 reservoirs.

TABLE 2.—*Record materials processed*

| | |
|--|---------|
| Reflex copies of records..... | 11, 879 |
| Photographic negatives made..... | 1, 984 |
| Photographic prints made..... | 7, 945 |
| Photographic prints mounted and filed..... | 3, 990 |
| Plate layouts made for manuscripts..... | 10 |
| Transparencies mounted in glass..... | 959 |
| Cartographic tracings and revisions..... | 70 |

During October 25-27 the annual meetings of the Mountain-Plain Historical Association were held in Lincoln and the Missouri Basin Project staff served as one of the local host organizations. As a programmed part of the meetings the group was invited to tour the facilities at the Project laboratory. During the Thanksgiving weekend members of the staff participated in the 14th Plains Conference for Archeology, held in Lincoln. On April 27 members of the staff participated in the annual meeting of the Nebraska Academy of Sciences. May 2, as a programmed part of the meetings of the Missouri Basin Inter-Agency Committee being held in Lincoln, the group was given a conducted tour of the Missouri Basin Project facilities.

There were over 30 members who visited the laboratory. During the annual meeting of the American Association of Museums held in Lincoln, May 21-25, the Missouri Basin Project served as one of the local host organizations. Staff members participated throughout the meetings.

Dr. Robert L. Stephenson, chief, when not in charge of field parties, devoted most of his time to managing the office and laboratory in Lincoln and preparing plans for the 1957 summer field season. He spent some time working on a summary report of the Missouri Basin Salvage Program for the calendar years 1952-55 and wrote several short papers for presentation before scientific groups. In January he attended and participated in the annual meeting of the Committee for the Recovery of Archeological Remains held in Washington, D. C. On April 9 he spoke before the Kansas City Archeological Society on the "Progress of Salvage Archeology in the Missouri Basin." On April 12 he went to Mitchell, S. Dak., where he was moderator for the afternoon session of the annual meeting of the South Dakota Social Sciences Association. The main topic under consideration was "South Dakota Prehistory" and at the end of the session Dr. Stephenson summarized the discussions and emphasized the needs of salvage archeology in the area. He served as chairman of the Anthropological Section of the Nebraska Academy of Sciences at its annual meeting held in Lincoln on April 27. At that time he also presented a paper on "Emerging Problems in Missouri Basin Archeology." On May 1, by special invitation, he presented a paper, "How Has Archeology Contributed to Our Historical Knowledge?" before one of the sessions of the Missouri Basin Inter-Agency Committee which was meeting in Lincoln. When the annual meeting of the American Association of Museums was held in Lincoln May 21-25, Dr. Stephenson served as a co-host and also was chairman for a program of Indian dances presented at an evening gathering. At one of the regular sessions, he spoke on the subject "Archeological Salvage Field Trips."

Dr. Warren W. Caldwell, archeologist, joined the staff of the Missouri Basin Project on August 22 and, as previously mentioned, was detailed for work at the Coralville Reservoir in Iowa. During the fall and winter months after his return from the field, he prepared a report on the work he had done along the Snake River just prior to joining the Missouri Basin Project, and completed a report on the results of his investigations in Iowa. He participated in several scientific meetings, presenting papers before sessions of the 14th Plains Conference for Archeology and the Nebraska Academy of Sciences. During the year two papers, of which he was a coauthor, were published: "A Burial Cache from the Spokane Region," *American Antiquity*, vol. 22, No. 1, and "The Problem of Northwest Coastal Interior Relationships as Seen from Seattle," *American Antiquity*,

vol. 22, No. 2. On June 1 Dr. Caldwell made a brief reconnaissance with G. Hubert Smith in the Big Bend Reservoir area for the purpose of determining where a camp should be established for the coming season's fieldwork and also for inspecting the sites where he expected to work. On June 11 he and his party moved into the field and were engaged in excavations at the end of the year.

Donald D. Hartle, temporary archeologist, joined the Missouri Basin Project staff on June 6 and on June 12 left the field headquarters with a party to begin excavations at several sites in the Oahe Reservoir area. Mr. Hartle was formerly a full-time member of the staff at Lincoln and is still working on reports of work which he did at that time. He was in the field at the end of the fiscal year.

Harold A. Huscher, field assistant and temporary archeologist, was working in the Big Bend area at the beginning of the fiscal year, and his activities there have been discussed in a preceding paragraph. After his return to the Lincoln headquarters in the fall, he devoted several months to the preparation of a preliminary appraisal report on his summer's work. In his report he made specific recommendations for an excavation program in the area during the 1957 field season. He left the project in January to complete work he was doing for the Department of Justice but returned in the capacity of a temporary archeologist late in June and proceeded to the Big Bend area where he was just beginning a survey program at the end of the fiscal year.

William N. Irving, temporary archeologist, joined the Project staff June 10 and on June 12 left Lincoln in charge of a party to begin the excavation of a series of sites in the Big Bend Reservoir. His activities there to the end of the fiscal year have previously been described.

Alfred E. Johnson, field archeologist and subsequently survey party chief, was in the field at the beginning of the fiscal year as a member of the Big Bend survey party under the direction of Mr. Huscher. In October he took over the task of making a survey and tests in the Toronto Reservoir area. He was in the field until mid-November when he resumed his academic work at the University of Kansas. He remained a part-time member of the staff, however, until early in January and during that period completed a report, "An Appraisal of the Archeological Resources of the Toronto Reservoir." Mr. Johnson did not rejoin the Project staff when fieldwork was resumed in the spring but went as an assistant with the party from the University of Kansas which was working in the Tuttle Creek Reservoir area at the end of the year. His Toronto report was in the process of being mimeographed on June 30.

Charles H. McNutt, archeologist, was appointed a member of the permanent staff of the Project on June 10. He devoted the following

week to learning the routine of the laboratory and Project office and on June 19 left Lincoln in charge of a party to start a series of test excavations in sites in the Oahe Reservoir area. His activities in that connection have already been discussed.

Robert W. Neuman, field assistant and archeologist, was in charge of an excavating party at the Lovewell Reservoir in Kansas at the beginning of the fiscal year and worked there until August. After returning to the Lincoln headquarters, he resigned from the Project in order to resume his academic work at the University of Nebraska. During the fall and winter months, however, he continued work on his report of the results of the excavations in the Lovewell area and returned to the Project as a part-time employee in May. On June 10 he was appointed temporary archeologist and left Lincoln with a field party on June 12 to begin excavations in a series of sites in the Big Bend area where he was occupied at the end of the fiscal year. Mr. Neuman participated in the annual meeting of the Nebraska Academy of Sciences on April 27, presenting a paper summarizing the results of his studies at the Lovewell Reservoir.

G. Hubert Smith, archeologist, during the periods he was at the field headquarters in Lincoln, devoted his time to analyzing the materials obtained from his field investigations and preparing reports on the results of his work. A 75-page manuscript on the findings made at the site of Fort Pierre II during the 1956 field season was completed. Mr. Smith also prepared an illustrated article on "Archeological Salvage at Historic Sites in the Missouri Basin," which was published in the Missouri Basin Field Committee Progress Report for March. During a 6-week period in February and March, Mr. Smith was detailed to the National Capital Parks, National Park Service, Washington, D. C., in order to make archeological investigations at the oldest known surviving building in the District of Columbia. The structure was built in 1766 and is known as the Old Stone House. Inasmuch as it was being restored, it was deemed advisable to make an archeological study of it before too much work was done on it. Mr. Smith found a number of interesting facts about the physical history of the structure and prepared a report on them for the National Capital Parks. At the request of the Minnesota Historical Society, Mr. Smith spent a week in Saint Paul where he assisted in planning future investigations of historic sites in that State and in checking over results of previous undertakings of that nature. Mr. Smith participated in the various scientific meetings held at Lincoln during the year, presenting papers pertaining to his work at Fort Pierre II and discussing "The Present Status of Research on Early Historic Sites of the Missouri Basin." In April he gave an illustrated talk on "Dakotans before the White Man" at the 18th annual meeting of the South Dakota Social Sciences Association. During May he took part in a meeting of

the Committee on Historic Sites of the Mississippi Valley Historical Association held at Lincoln. On June 10 Mr. Smith left with a field party for the Big Bend Reservoir area and at the end of the fiscal year was engaged in excavations previously described.

Richard P. Wheeler, archeologist, was at the Lincoln headquarters during the entire year. Most of his time was spent completing a lengthy detailed manuscript pertaining to archeological remains in the Angostura Reservoir area, South Dakota, and the Keyhole and Boysen Reservoir areas in northeastern and west-central Wyoming. The manuscript is based on data gathered by reconnaissance parties of the Missouri Basin Project during the period 1946-51 and information obtained by excavating parties in 1950-52. Mr. Wheeler served as general chairman of the 14th Conference for Plains Archeology in November and presented a paper, "Archeological Field Data and Their Interpretation," at the annual meeting of the Nebraska Academy of Sciences in April. In May he gave an illustrated talk before the Interprofessional Club of Lincoln on the subject "Some Recent Archeological Discoveries in the Missouri Basin." Mr. Wheeler was in the Lincoln office at the end of the fiscal year.

The activities of Dr. Robert E. Greengo and Dr. James H. Howard, archeologists, who were temporarily based at the headquarters of the Missouri Basin Project, have been discussed elsewhere and need no further comment.

Snake River Basin.—At the beginning of the fiscal year a field party was excavating in sites along the Snake River in the area where the Idaho Power Co. is building its Brownlee and Oxbow dams. Test digging was done in a number of sites, and extensive excavations were carried on in four habitational areas. Two of the latter were on the Oregon side of the Snake River at Robinette and two on the Idaho side at Big Bar. Most of the material found there indicates that the sites date from the late prehistoric period to the early period of European contact but at two of the locations there were items representing much earlier horizons. The general picture obtained by the investigations is that of an early expansion of Great Basin cultural features into the Northwest and their replacement by a more dynamic cultural pattern working upstream from mid-Columbia centers. The artifacts collected show that the people had a basically hunting-gathering type of economy. Implements associated with fishing were for the most part lacking but an abundance of fresh-water mussel shells in the middens indicates that aquatic food was actually consumed. Such evidence as was found pertaining to habitations suggests that rather flimsy brush superstructures were erected over saucer-shaped floor areas. At the time of the arrival of the first Europeans, that area was inhabited by a band of the Shoshoni known as the "Mountain Sheep Eaters." They were a seasonal nomadic group subsisting mainly by

hunting and gathering activities. They have not been known to visit the region regularly since the 1880's and their survivors are now mainly on reservations in Idaho and Oregon.

Cooperating institutions.—Several State and local institutions continued to cooperate in the Inter-Agency Salvage Program throughout the year. In addition to those previously mentioned for the Upper Missouri Basin area, the University of Missouri began a survey of the Pomme de Terre Reservoir on the river of the same name in Missouri and continued its investigations in the Table Rock Reservoir area on the White River. The University of Kansas started a series of investigations in the Tuttle Creek Reservoir basin in Kansas, and the University of Wyoming excavated in the Glendo Reservoir area in Wyoming. In New Mexico the School of American Research began a survey of the Navajo Project, and in Arizona the Museum of Northern Arizona started a salvage program in the Glen Canyon Reservoir basin. The University of Utah also participated in the Glen Canyon investigations. The University of Texas had an excavation program in the Ferrells Bridge area. The University of Oklahoma worked in the Keystone and Oologah Reservoirs in that State. In California investigations were made in the Monticello Reservoir area by Sacramento State College and at the Trinity River Project by the University of California at Berkeley. At the Dalles Reservoir on the Columbia River, the University of Oregon excavated on the Oregon side of the river and the University of Washington on the north side. Washington State College started an excavation project in the Ice Harbor Reservoir basin.

ARCHIVES

The manuscript collections of the Bureau continued to be utilized by anthropologists and other students. About 222 manuscripts were consulted by searchers, either in person or through the purchase of reproductions. In addition, 95 mail inquiries concerning manuscripts were received and numerous manuscripts were consulted by the archivist in preparing replies. As in previous years, as individual manuscript files were called into use, their contents were reviewed and more fully recorded in the catalog; numerous annotations were made and about 55 new entries drafted. A number of new descriptive lists of manuscripts having to do with specific tribes or subjects were also prepared for distribution.

Utilization of the Bureau's photographic collections by scholars, publishers, and the general public as a source of documentary information and illustrative material continued to increase. There were 444 inquiries and purchase orders for photographs (as against 294 in 1956); and 1,019 prints were distributed (978 in 1956). The archivist continued to prepare lists describing photographs available for specific subjects or tribes; 65 such lists are now available.

A number of photographic collections relating to specific areas were studied by specialists, who not only derived useful historical information from them for their own studies, but in turn were able to supply for the Bureau records numerous additional details concerning the identification of subject, locality, etc., thus increasing the value of the collections to future users.

Over 400 photographic views of Mesa Verde, Colo., and vicinity, made and collected by J. W. Fewkes in the period 1908-22, were studied by members of the National Park Service staff at Mesa Verde National Park; fuller identifications and descriptions were provided for many of these by the Park staff. About 40 of the pictures were considered of especial historical interest and were copied by them for the Mesa Verde files.

A series of 124 photographs of ruins in Chaco Canyon, N. Mex., made by Victor Mindeleff in 1887 was studied by National Park Service archeologists at Chaco Canyon National Monument, N. Mex., and Southwestern National Monuments, Globe, Ariz. They identified a number of previously unidentified views and provided details of locality and additional notes on others.

These series are of considerable historical interest in that they show ruins in states of preservation and repair differing from their present state; a few show ruins that are no longer standing.

Additional caption information was provided by Dr. Harold C. Conklin of Columbia University for a group of 121 photographs of native peoples of the Philippine Islands made and collected by Col. Dache M. Reeves prior to 1938.

Several members of the Cheyenne and Arapaho tribes, who were in Washington on business, visited the Archives and provided additional identifications and other information about photographs of Cheyennes and Arapahoes taken in the early 1900's.

During the year a number of new photographs were added to the collections through gift or loan for copying.

Twenty-two photographs of Chippewa, Ottawa, and Potawatomi Indians living in the State of Michigan during the period 1853-ca. 1920 were lent for copying by the Michigan Historical Commission, through Dr. Philip P. Mason, archivist.

Dr. Paul H. Ezell, of the Department of Anthropology, University of San Diego, San Diego, Calif., lent for copying 11 photographs relating to the Pima Indians; they range in date from 1896 to 1954.

Twenty-five original photographic prints relating to a number of Plains and Southwestern tribes were received as a gift from the Pennsylvania State Museum, Harrisburg, Pa., through John Witthoft, director. Most of the photographs were made in the early 1880's by the photographic firm of Baker and Johnston.

A gift of 26 glass negatives of outdoor and studio portraits of Indians of the Southwest, principally Apaches, was made by Dr. E. M. Wurster of Williamsport, Pa., through John Witthoft, of the Pennsylvania State Museum. The photographs are believed to have been taken by a photographer named Eames.

Two groups of photographic prints were obtained for reference purposes from other institutions (which retain the negatives and the right to grant publication permission). Both groups are photographs of drawings made by Robert Ormsby Sweeny in Minnesota in 1852, the year in which he first settled in St. Paul. One set of prints was received from the British Museum and was made from that institution's collection of 20 original drawings by Sweeny. Another set of 20 photographs represents a selection from a group of more than 60 Sweeny drawings pertaining to Indian subjects in the collections of the Minnesota Historical Society.

ILLUSTRATIONS

The illustrator on the staff of the Bureau devoted his time to the preparation of a variety of maps, graphs, and diagrams, the designing of charts, the restoration and retouching of photographs, and the preparation of various other illustrative work. An appreciable amount of time was allocated to making drawings for other departments of the Institution.

EDITORIAL WORK AND PUBLICATIONS

There were issued one Annual Report, two Bulletins, and one miscellaneous publication, as follows:

- Seventy-third Annual Report of the Bureau of American Ethnology, 1955-1956. ii+23 pp., 2 pls. 1957.
- Bulletin 161. Seminole music, by Frances Densmore. xxviii+223 pp., 18 pls., 1 fig. 1956.
- Bulletin 162. Guaymí grammar, by Ephraim S. Alphonse. ix+128 pp. 1956.
- Miscellaneous publication. List of publications of the Bureau of American Ethnology, with index to authors and titles. Revised to June 30, 1956. 112 pp. 1956.

The following publications were in press at the close of the fiscal year:

- Bulletin 164. Anthropological Papers Nos. 49-56:
- No. 49. The Ormond Beach Mound, east central Florida, by Jesse D. Jennings, Gordon R. Willey, and Marshall T. Newman.
- No. 50. Hair pipes in Plains Indian adornment, a study in Indian and White ingenuity, by John C. Ewers.
- No. 51. Observations on some nineteenth-century pottery vessels from the Upper Missouri, by Waldo R. Wedel.
- No. 52. Revaluation of the Eastern Siouan problem, with particular emphasis on the Virginia branches—the Occaneechi, the Saponi, and the Tutelo, by Carl F. Miller.

- Bulletin 164. Anthropological Papers Nos. 49-56—Continued
- No. 53. An archeological reconnaissance in southeastern Mexico, by Matthew W. Stirling.
- No. 54. Valladolid Maya enumeration, by John P. Harrington.
- No. 55. Letters to Jack Wilson, the Paiute Prophet, written between 1908 and 1911, edited by Grace M. Dangberg.
- No. 56. Factionalism at Taos Pueblo, New Mexico, by William N. Fenton.
- Bulletin 165. Music of Acoma, Isleta, Cochiti, and Zuñi Pueblos, by Frances Densmore.
- Bulletin 166. River Basin Surveys Papers, No. 8. Excavations in the McNary Reservoir Basin near Umatilla, Oregon, by Douglas Osborne. With appendixes by Marshall T. Newman, Arthur Woodward, W. J. Kroll, and B. H. McCleod.
- Bulletin 167. Archeological investigations at the mouth of the Amazon, by Betty J. Meggers and Clifford Evans.
- Bulletin 168. The Native Brotherhoods: Modern intertribal organizations on the northwest coast, by Philip Drucker.
- Bulletin 169. River Basin Surveys Papers, Nos. 9-14:
- No. 9. Archeological investigations in the Heart Butte Reservoir area, North Dakota, by Paul L. Cooper.
- No. 10. Archeological investigations at the Tuttle Creek Dam, Kansas, by Robert B. Cumming, Jr.
- No. 11. The Spain site (39LM301), a winter village in the Fort Randall Reservoir, South Dakota, by Carlyle S. Smith and Roger T. Grange, Jr.
- No. 12. The Wilbanks site (9CK-5), Georgia, by William H. Sears.
- No. 13. Historic sites in and around the Jim Woodruff Reservoir area, Florida-Georgia, by Mark F. Boyd.
- No. 14. Six sites near the Chattahoochee River in the Jim Woodruff Reservoir area, Florida, by Ripley P. Bullen.
- Bulletin 170. Excavations at La Venta, Tabasco, 1955, by Philip Drucker, Robert F. Heizer, and Robert J. Squier. With appendixes by Jonas E. Gullberg, Garniss H. Curtis, and A. Starker Leopold.

Publications distributed totaled 28,558 as compared with 17,018 for the fiscal year 1956.

COLLECTIONS

Acc. No.

214119. 3 cedar-bark mats from Nootka Indians, British Columbia, Canada.
214961. 27 miscellaneous archeological specimens from Tennessee and Illinois collected by J. W. Emmert and G. Fowke before 1894.
205014. 15 land snails from Ecuador and 33 ethnological specimens from Ecuador and Florida (through Dr. M. W. Stirling).
205360. John W. Powell catalog of Indian collections deposited in the Smithsonian Institution, and supplement to catalog.
207445. 13 specimens associated with Zuñi Indian religious cult practices.

FROM RIVER BASIN SURVEYS

212741. 2 fresh-water mussels from Iowa (through Robert L. Stephenson).
211157. Archeological material from 4 Nebraska counties, 1955.
211158. Archeological material from 2 sites in Oahe Reservoir, Stanley County, S. Dak., and human skeletal material, 1955.
213526. Archeological material from Rock Village, Mercer County, N. Dak., 1950-52.

Acc. No.

213765. 9 specimens of archeological material from Pembina River Reservoir, N. Dak., 1948.
214031. 1,332 specimens of archeological material from Fort Randall area, Gregory and Lyman Counties, S. Dak., 1950-52.
214234. Archeological material from Garrison Reservoir, McLean County, N. Dak., 1952.
214612. Archeological material from Fort Randall Reservoir, Lyman County, S. Dak., 1950.

MISCELLANEOUS

Dr. John R. Swanton, Dr. John P. Harrington, Dr. A. J. Waring, Jr., and Ralph S. Solecki continued as research associates of the Bureau of American Ethnology.

Dr. Frances Densmore, who had been a collaborator of the Bureau for a period of 50 years, died June 5, 1957, at her home in Red Wing, Minn., at the age of 90. Shortly before her death she corrected the proof of her last bulletin for the Bureau entitled "Music of Acoma, Isleta, Cochiti, and Zuñi Pueblos," which will be distributed in August 1957. Thirteen of her papers on Indian music were published by the Bureau as complete bulletins, five as anthropological papers, and one was published in the Annual Report series.

Information was furnished during the past year by staff members in reply to numerous inquiries concerning the American Indians, past and present, of both continents. Twelve bibliographies or information leaflets were prepared and duplicated for distribution to the public, as follows:

- SIL-16, rev. Indian Crafts and Indian Lore. Bibliography.
- SIL-50. Selected List of Portraits of Prominent Indians.
- SIL-65, rev. Bibliography on the American Indians.
- SIL-76. Statement regarding the Book of Mormon.
- SIL-79. Indian Songs and Dances. Bibliography.
- SIL-81. Selected Bibliography on Stone-chipping Methods.
- SIL-89. Selected References on the Plains Indians.
- SIL-92. Origin of the American Indian.
- SIL-93. Trails and Trade Routes.
- SIL-96. Photographic Collections pertaining to the American Indians.
- SIL-98. Selected References on the Seminole Indians.
- SIL-99. American Indian Medicine. Bibliography.

Many new descriptive lists and information leaflets were prepared in answer to requests for information on the Bureau's photographic and manuscript collections. There continued to be a popular demand for information, published material, and photographs from teachers—particularly of primary and secondary grades—from Scout and other civic organizations, and from the general public. Information and reference material for term papers were constantly requested by hundreds of high school and college students. Staff mem-

bers and the archivist were frequently consulted by publishers regarding the progress made in the various fields of anthropology and on specific projects for background material to be used in scientific and popular magazines and books, appropriate pictures and illustrations. Many specimens were identified for owners and data supplied to them.

Respectfully submitted.

M. W. STIRLING,

Director, Bureau of American Ethnology.

DR. LEONARD CARMICHAEL,

Secretary, Smithsonian Institution.

Report on the Astrophysical Observatory

SIR: I have the honor to submit the following report on the operations of the Astrophysical Observatory for the fiscal year ended June 30, 1957:

The Astrophysical Observatory includes two research divisions: the Division of Astrophysical Research, for the study of solar and other sources of energy impinging on the earth, and the Division of Radiation and Organisms, for investigations dealing with radiation as it bears directly or indirectly upon biological problems. Three shops—for metalwork, woodwork, and optical electronic work—are maintained in Washington to prepare special equipment for both divisions, and a field station for solar observation is located at Table Mountain, Calif.

DIVISION OF ASTROPHYSICAL RESEARCH

The transfer of the office of the Director of the Observatory and the Division of Astrophysical Research from Washington to Cambridge, Mass., has made possible a close liaison with the Harvard College Observatory—a working association that proved highly effective during the year. There is every indication that this relationship between two of the great astrophysical centers in the United States will continue over the years to stimulate the efforts and increase the effectiveness of both institutions.

Important progress was made in the past year in the reorientation of the Astrophysical Observatory's research program toward broader scientific investigation of various solar-system phenomena—a program that should bear heavily upon the scientific progress of our nation during the coming decades. Concentration, as in the past, concerns the impact of radiations, atoms, and meteoritic particles on the earth, both in its atmosphere and upon its surface. All these phenomena represent energy sources that affect our atmosphere and, to varying degrees, the conditions in which we live, particularly the technological instrumentation which has become such a vital part of our great modern civilization. Vigorous and effective research programs in the special fields of activity of the Observatory are now firmly established, and a considerable portion of the work is closely integrated with the massive effort of the International Geophysical Year. This is particularly true of the satellite program, studies of the upper atmosphere, and various aspects of the meteoritical research programs.

One of the long-term goals of the Astrophysical Observatory is to conduct astronomical observations and experiments above the atmosphere and to develop relevant techniques of value to the research program. When this goal has been attained, we shall not only improve vastly the precision and significance of our observations by eliminating the deleterious effects of a hazy, cloudy, turbulent, and mostly opaque atmosphere but also greatly increase our understanding of the interactions, because the external energy sources affect profoundly this ocean of atmosphere in which we live.

Solar astrophysics.—Early in the fiscal year, Dr. Theodore E. Sterne joined the Astrophysical Observatory as Associate Director, with the principal duty of supervising solar astrophysical research. The following are among the studies that have been pursued in this field:

The Table Mountain station continued to operate despite atmospheric disadvantages outlined in the 1956 report. Of the observing staff, F. A. Greeley retired during the year, and Stanley Aldrich went on leave of absence at the end of the year.

Careful statistical studies of the variation of solar radiation intensity were made by Dr. Sterne and by Mrs. Nannielou Dieter, who joined the Observatory for the summer of 1956. By comparing simultaneous Montezuma and Table Mountain values between 1926 and 1955, they found that the root-mean-square value of real changes in the solar constant during this interval was no greater than 0.0032 calorie per square centimeter per minute, or about 0.17 percent of the solar constant itself. This result demonstrates the high precision of the fundamental observations made over the years. They also calculated correlations from the observations at each station separately and found no periodicities that were common to the two stations.

A thorough study is being made for the improvement of the radiation-measuring program by changes in the site, the observing equipment, and the frequency of observations.

Dr. Max Krook has been investigating the theory of nonsteady phenomena in the solar atmosphere and corona. His studies include the effects of convective instabilities and magnetic fields on the state of motion of the solar atmosphere, and have shed light on the production of such events as sunspots, flares, prominences, and the production of cosmic rays.

Theoretical studies of the propagation of nonadiabatic acoustic waves in the solar atmosphere have been made by Dr. Charles Whitney, who joined the staff in July 1956. He has succeeded in constructing a theoretical model for solar granulation (small-scale brightness fluctuations observed on the solar disc) which is in accord with observations. Although such studies have been made with particular emphasis on solar activity, they will have a much wider application.

Dr. John H. Waddell has been investigating, theoretically and observationally, the velocity fluctuations in the solar photosphere and their effect on the line spectrum of the solar disc.

Dr. Alan S. Meltzer, who joined the staff in October 1956, has been conducting two studies of solar line profiles: I, variation of Doppler half-width with atomic weight; II, parity effect. During the months of March and April 1957, he made observations relevant to these two studies at the Sacramento Peak Observatory, Sunspot, N. Mex.

Dr. William M. Sinton, who joined the staff in July 1956, left in May 1957 for the Lowell Observatory at Flagstaff, Ariz. While with the Smithsonian he used photoconductive equipment and the Wyeth 61-inch reflecting telescope of the Harvard College Observatory to observe the intensity of radiation from the planet Mars in the vicinity of 3.46 microns, during the planet's 1956 opposition. The reflection spectra of most planets show absorption in this spectral region arising from the carbon-hydrogen bond. The absorption bands are so distinctive that if present in Mars light they would be evidence for organic molecules and, therefore, of life on Mars. The electrical measurements with the 61-inch telescope indicated the probable presence of the distinctive bands and thus of life, probably vegetable, on Mars. The effect of solar radiation on Mars is obviously important in understanding its effects on the earth.

Meteoritical studies.—Meteoritical studies have been a part of the Smithsonian Institution's scientific research program for over 80 years, during which time its meteorite collection has been developed into one of the most outstanding in the world. The only tangible extraterrestrial material, meteorites are of great astrophysical interest. Under Dr. John S. Rinehart's direction, the Astrophysical Observatory undertook, during 1956, a freshly oriented program of meteoritical research, with the principal objective of resolving astrophysical problems. This program is now well under way with the pursuit of the following specific activities: A study of the processes that cause the ablation of meteorites during their flight through the atmosphere; the design and construction of an electron fluorescent X-ray micronalyzer to be used especially for studying the distribution of nickel, iron, and cobalt within meteorites; the collection and identification of airborne extraterrestrial material; the sending of an expedition to the Arizona Meteorite Crater for determining the distribution of meteoritic debris about the crater; and the determination of the ages of meteorites by radiochemical techniques. All these efforts have been directed toward solving the riddles of the ages—the origins and natures of extraterrestrial material.

The study of ablation of meteorites has been concerned with the distinct shapes and surface features of a large number of meteorites,

and the examination of the internal structure of meteorites from a metallurgical point of view. The plan is to prepare detailed descriptions of the topology and morphology of individual meteorites, especial interest being paid to those that show ablation. While very little can yet be said about the total amount of meteoritic material lost, meteorite size and material are both very critical factors. It has been found that small (up to 3 inches in diameter) meteorites are smoothly sculptured; large stones exhibit shallow elongated pits or depressions (2 cm. by 1 cm. by 5 mm. deep); and large irons, very deep pits (5 cm. in diameter and 3 cm. deep). The number, distribution, and size of the depressions depend upon the relation of a particular surface or portion of surface to the direction of flight. Pronounced irregularities of shape increase ablation. Finally, heat from the surface seems to penetrate into the meteorite at most only a few millimeters beyond where ablation leaves off. Dr. E. P. Henderson, of the United States National Museum, is actively engaged in this project, which is being supported by the United States Air Force Office of Scientific Research. One of the most difficult and challenging problems facing the present-day aerodynamical engineer is the rational design of pre-flight devices that will withstand the rigors of the passage through the atmosphere. The investigations of the Astrophysical Observatory will yield basic data which may aid in a solution of these problems.

Dr. F. Behn Riggs, Jr., and Prof. Andrew Lang have nearly completed the design and construction of an electron fluorescent micro-analyzer. The fundamental principle of the instrument is the direct excitation of X-radiation characteristic of the elements of the sample by a fine beam (approximately 5 microns in diameter) of electrons focused on the selected site. The method will be applied first to the determination of nickel-iron-cobalt percentages in meteorites that have Widmanstaetten figures. The method is applicable to microscopic areas or particles.

An expedition consisting of Dr. John S. Rinehart, Nicholas Matalas, R. O'Neil, and R. Olsen was in residence at the Barringer Meteorite Crater in Arizona during the summer of 1956, to determine the distribution of minuscule bits and pieces of meteoritic material in the soil around the crater. The expedition collected and processed some 700 soil samples from over an 80-square-mile area. Especially designed magnetic separators were used to recover the meteoritic material. The results have indicated that the debris lies in a definite pattern; it is symmetrically distributed about a line that runs roughly about 15° north of east; while symmetrical, the distribution is not smooth but contains several local areas in which the abundance of meteoritic material is high; the crater does not lie at the center of the pattern; and there is a concentration of material to the east of the crater. These

findings strongly suggest that the meteorite approached the crater from a direction slightly to the south of west rather than a north-northwesterly direction, as has been previously assumed. The total amount of finely divided meteoritic material was found to be about 12,000 ordinary tons, which fixes a lower limit to the mass of the meteorite that formed the crater. The expedition was supported in part by the Geophysics Research Directorate of the Air Force Cambridge Research Center.

A concentrated effort is now being made to estimate the rate of accretion of meteoric material by the earth and to establish the physical nature of this material. Most of the mass is probably accreted in the form of dust and small particles. From a practical point of view, astronomical ventures and possibly rainfall could be influenced by such material. Thus far a few collections of dust (presumably meteoric) have been made on the ground. A method will be devised and a device constructed for collecting micrometeorites from aircraft and balloons at and above stratospheric altitudes. The designs of collectors are well underway, and an Air Force-furnished aircraft is in sight for use in making collections. Paul Hodge is working actively on this project.

Dr. E. L. Fireman is continuing his ground-breaking studies of the stable and radioactive isotopes produced by cosmic rays in meteorites and by high-energy particles in targets. Previously he conducted this research at the Brookhaven National Laboratory. Part of the equipment used for these studies has been transferred from Brookhaven under a research contract with the Atomic Energy Commission and put into operation at the Astrophysical Observatory, where a radiochemistry laboratory has been set up. Dr. Fireman also collaborated with Dr. J. Zähringer to measure the depth variation of tritium and argon-37 produced by high-energy protons in iron.

Dr. Luigi G. Jacchia has supervised the reduction by accurate techniques of meteors photographed with the Super-Schmidt cameras under the Harvard Meteor Program and has conducted research on the physical nature of meteors through a study of their deceleration and fragmentation inside the earth's atmosphere. Among the significant results of this research in the course of the elapsed year can be listed the finding that there is no clear-cut evidence for the presence of hard-bodied meteors of asteroidal origin among 361 Super-Schmidt meteors which were analyzed, and the result of the comparison of visual and photographic magnitudes of meteors, which showed that the "color index" of meteors is rather independent of velocity, but shows a strong dependence on meteor brightness.

Upper atmosphere and satellite-tracking programs.—The responsibility for the optical tracking of the IGY earth satellites was as-

signed to the Smithsonian Institution by the National Academy of Sciences and the National Science Foundation at the recommendation of the United States National Committee of the International Geophysical Year. Dr. J. Allen Hynek, who became an Associate Director of the Observatory on July 1, 1956, has been in charge of the Optical Tracking Program. Major extension of staff in the tracking project began in September 1956, and has grown steadily during the course of the year as various specialists were invited to join the staff under contract through funds furnished by the National Science Foundation. As of June 30, 1957, the satellite-tracking staff consisted of 32 persons.

The optical tracking program for the satellite has three main divisions: The photographic tracking program under the supervision of Dr. Karl G. Henize; the computational, analysis, and communications division under the supervision of Dr. Don Lautman; and the visual search program, popularly termed Moonwatch, under the direction of Leon Campbell, Jr.

The precision photographic program will employ 12 Baker-Nunn Schmidt cameras at strategic locations in a worldwide belt. The sites will be located in Florida, New Mexico, Hawaii, Japan, Australia, India, Iran, Spain, South Africa, Argentina, Peru, and the Netherlands Antilles.

The designs of the mechanical and optical parts of the telescopes have been completed, and the instruments are under active construction. The mechanical portions of the telescope-cameras are being constructed by the Boller and Chivens Co. in South Pasadena, using the designs of Joseph Nunn, while the optical components are being constructed at the shops of the Perkin-Elmer Corp., according to designs made by Dr. James G. Baker. Glass for the 30-inch mirrors is being furnished by the Corning Glass Co.

It is expected that the tracking stations will be in operation during the latter part of 1958. Each station is to be equipped with precision timing devices and all auxiliary apparatus necessary to the maintenance of an essentially complete observatory. The stations are being operated, wherever possible, as joint cooperative ventures with the country concerned, and it is a pleasure to report that the highest degree of cooperation has been found in all cases. This network of observing stations, it might be pointed out, continues the long-established Smithsonian tradition of operating various strategically located observatories around the world.

The telescopic cameras designed for satellite tracking have been made as versatile as possible to allow for a wide variety of sizes and shapes of satellites expected to be launched by this and other countries during the course of the IGY. Indeed, it should even be possible

for these instruments to photograph a highly reflecting sphere the size of a tennis ball at a distance of more than 200 miles.

The popular interest and cooperation generated by the Moonwatch program have far exceeded the expectations of the Astrophysical Observatory. In the United States alone there are 90 registered Moonwatch teams comprising more than 1,500 voluntary observers, many of whom are amateur astronomers of considerable experience in the observation of the sky. A regular series of Moonwatch bulletins has been initiated by the Smithsonian Astrophysical Observatory, published in *Sky and Telescope*, with reprints furnished to all registered observers. The bulletins are regularly translated into Spanish for distribution in South America and Spain, while the English edition is mailed to many parts of the world. Moonwatch stations have been established also in Japan, Iran, Korea, Argentina, Peru, Chile, Australia, Union of South Africa, Pakistan, and India. One aspect of the Moonwatch program which should not be underestimated is its contribution to the creation of interest among the public in scientific matters. Moonwatch teams provide opportunity for serious people without specific scientific training to participate in the IGY program and to render a definite scientific service.

The computation and analysis division of the program is now prepared, through the use of electronic calculators, to handle orbital computations from the raw data furnished by the precision stations as well as the Moonwatch stations. International Business Machines Corp. has made possible the use of their 704-computer installation at Massachusetts Institute of Technology. The Observatory will receive up to 1 hour a day of machine time until June 30, 1959, for satellite computations. IBM will also supply one or two programmers for technical assistance.

Such computations will furnish the immediate ephemerides for satellite positions, so that the precision tracking stations can be properly alerted, and the Moonwatch teams and public in general informed of the satellite's immediate whereabouts. The long-range purposes of the computation and analysis division, however—and its most important aspect—are the detailed analyses of the changes in the various elements of the satellite orbit. These orbital calculations are essential to the proper use of the satellite as a scientific vehicle for geodetic and geophysical purposes.

In support of upper-atmospheric studies by satellite methods Dr. Sterne has completed a theoretical research on the gravitational motion of a particle of small mass near a planet flattened by rotation. He discovered a novel Hamiltonian function that led to an exact analytical solution for the motion of a particle in very nearly the correct field of force. Dr. Sterne also developed special mathematical procedures for

inferring the density of the earth's atmosphere from a satellite at such low altitude. In the course of this work he extended a U. S. Air Force atmospheric model to much greater heights than the 540 kilometers at which the Air Force abandoned it.

PUBLICATIONS

Volume 1 and numbers 1-4 of volume 2 of the Smithsonian Contributions to Astrophysics were published. Volume 1, issued under the partial support of the National Science Foundation, included *New Horizons in Astronomy*, a series of 39 papers by eminent American astronomers outlining future research of importance in astronomy. Research contributions on meteors and solar work comprised the remainder of the publications.

During the current year the following publications by staff members of the Astrophysical Observatory appeared in various scientific journals:

- FIREMAN, E. L., and SCHWARZER, D. Measurement of Li^6 , He^3 and H^3 in meteorites and its relation to cosmic radiation. *Geochim. and Cosmochim. Acta*, vol. 11, No. 4, April 1957.
- HENIZE, KARL G. The Baker-Nunn satellite-tracking camera. *Sky and Telescope*, vol. 16, pp. 108-111, January 1957.
- JACCHIA, L. G. A preliminary analysis of atmospheric densities from meteor decelerations for solar, lunar and yearly oscillations. *Journ. Meteorol.*, vol. 14, pp. 34-37, 1957.
- KROOK, MAX. Electrodynamics of fluids and plasmas. *Smithsonian Contr. Astrophys.*, vol. 1, pp. 53-58, 1956.
- MELTZER, ALAN S. Spectroscopic investigation of Algol. *Astrophys. Journ.*, vol. 125, p. 359, 1957.
- MELTZER, ALAN S., SCHARZSCHILD, M. and B., and SEARLE, L. A spectroscopic comparison between high- and low-velocity K giants. *Astrophys. Journ.*, vol. 125, p. 123, 1957.
- RINEHART, JOHN S. Applications of high speed photographic techniques to hypervelocity free-flight investigations. *Proc. 3d Int. Symp. High Speed Photogr.* Butterworth Scientific Publications, 1956.
- . Meteorites. *Smithsonian Contr. Astrophys.*, vol. 1, p. 81, 1956.
- . Ablation of meteorites [abstract]. *Bull. Amer. Phys. Soc.*, vol. 2, p. 45, 1957.
- . A soil survey around the Barringer Crater. *Sky and Telescope*, vol. 16, No. 8, June 1957.
- . Arizona's meteorite crater, by H. H. Nininger [review]. *Science*, vol. 125, p. 829, 1957.
- WHIPPLE, FRED L. Meteors. *Smithsonian Contr. Astrophys.*, vol. 1, pp. 83-86, 1956.
- . The scientific value of artificial satellites. *Journ. Franklin Inst.*, vol. 262, pp. 95-109, 1956.
- . Moontracking. *Saturday Rev.*, vol. 39, No. 35, pp. 37-39, Sept. 1, 1956.
- . Wanted: Spotters for the satellites. *Science Digest*, December 1956, pp. 33-37.
- . Moon. *World Book Encyclopaedia*, pp. 5227-5231, 1957.
- . The sunward tail of comet Arend-Roland [letter]. *Nature*, vol. 179, p. 1240, 1957.

WHIPPLE, FRED L., DAVIS, R. J., and ZIRKER, J. B. The orbit of a small earth satellite. In "Scientific Uses of Earth Satellites," pp. 1-22. University of Michigan Press, 1956.

———. Time available for the optical observation of an earth satellite. *Ibid.*, pp. 23-28.

WHIPPLE, FRED L., and JACCHIA, L. G. The Harvard photographic meteor programme. In "Vistas in Astronomy," vol. 2. Pergamon Press, 1956.

———. The orbits of 308 meteors photographed with Super-Schmidt cameras [abstract]. *Astron. Journ.*, vol. 62, pp. 37-38, 1957.

———. Reduction methods for photographic meteor trails. *Smithsonian Contr. Astrophys.*, vol. 1, pp. 183-206, 1957.

WHIPPLE, FRED L., and WRIGHT, F. W. Methods for the study of shower radiants from photographic meteor trails. *Smithsonian Contr. Astrophys.*, vol. 1, pp. 239-243, 1957.

OTHER ACTIVITIES

A conference on Constants for Orbital Calculations was held at the Astrophysical Observatory on January 25, 1957. On February 15, 1957, a conference on Solar Measurements was held at the Smithsonian Institution, Washington, D. C. The Smithsonian Astrophysical Observatory and the Harvard College Observatory acted as co-hosts at the meetings of the American Astronomical Society, May 8-11, 1957. The Astrophysical Observatory was host to the international Third Cosmical Gas Dynamics Symposium, June 24-29, 1957.

Various staff members attended meetings of the American Astronomical Society, the American Physical Society, and the Third Cosmical Gas Dynamics Symposium.

Dr. E. L. Fireman attended the National Academy of Sciences conference on Nuclear Geology and the Gordon Conference on Nuclear Chemistry.

Dr. John S. Rinehart participated in the Third International Symposium on High Speed Photography in London, September 1956; the Institution of Mechanical Engineers Conference on the Properties of Materials at High Rates of Strain in London, May 1957; the Air Force Office of Scientific Research and Naval Research Laboratory Symposium on Hyper-velocity and Impact Effects, May 1957; and the National Academy of Sciences Symposium on Tektites, Washington, June 1957.

In the interest of obtaining optical tracking sites for the Satellite Tracking Program, Dr. J. Allen Hynek traveled to South America, visiting Montevideo, Uruguay; Santiago, Chile; Lima, Peru; Antofagasta, Peru; Arequipa, Peru; and Curaçao, N. W. I., during January 1957. He also traveled to Teheran, Iran; Delhi, India; Tokyo, Japan; and Hawaii during the latter part of May and early June of 1957 to inspect optical tracking sites. Dr. Karl G. Henize traveled to Spain and South Africa between March 20 and April 7, 1957, to inspect optical tracking sites.

The Director attended and contributed to the International Geophysical Year conference at Barcelona, Spain, September 1956, and the International Federation of Astronautics Congress at Rome in September 1956. He was panel leader of and contributor to an Astronautics Symposium, San Diego, January 1957, sponsored by U. S. Air Force, Office of Scientific Research, and by the Convair Corp.

In national science and defense, the Director contributed by serving in the following capacities: Chairman of Technical Panel on Rocketry of the International Geophysical Year; member Technical Panel on the Earth Satellite Program of the International Geophysical Year; member of the working group on Tracking Earth Satellites on above panel; member Panel of the Atmosphere of the Scientific Advisory Board to the Air Force; member Committee on Cosmic and Terrestrial Relationships of the American Geophysical Union; Editor, Harvard Announcement Cards; and general editor, Smithsonian Contributions to Astrophysics.

DIVISION OF RADIATION AND ORGANISMS

(Prepared by R. B. WITHROW, Chief of the Division)

The major activities of this division have been concerned with fundamental physiological and biochemical research on the role of light in regulating growth in higher plants. Seed germination, seedling growth, flowering, and the development of what is commonly referred to as a "normal plant" are controlled by light. Pigments within the organism absorb the light and convert it into chemical bond energy and thus initiate a chain of events that produces the observed growth effects. In most instances, relatively little light is necessary. This is in contrast to the photosynthesis of sugars where very high intensities are required for optimal results. There is a similar group of light-controlled reactions in animals which regulate many phases of reproductive behavior. Plans are now being implemented to investigate this phase of animal physiology.

The two general groups of photochemical reactions that regulate plant growth are (1) those controlling photomorphogenesis, which are activated chiefly by red and far-red light, and (2) those concerned with phototropism, controlled principally by blue light. The respective pigment systems channel the energy into different biochemical pathways and therefore induce entirely different physiological responses.

Photomorphogenesis.—Seed germination, seedling development, flowering, bud development of woody plants, and changes in stem length are examples of formative processes controlled by light from the red end of the spectrum. Collectively, these may be grouped under the term "photomorphogenesis."

Reports from other laboratories have indicated that chemicals such as gibberellin and kinetin will, to some extent, replace red irradiation in promoting some photomorphogenetic processes such as seed germination and flowering. These materials have been tested on seedling growth during the past year by Dr. W. H. Klein and Victor Elstad. It was found that gibberellin and kinetin could not substitute for red irradiation in this case. Both inhibited the growth induced by a red exposure and produced results similar to those of the growth-regulating hormone, indoleacetic acid. Gibberellin and red radiant energy initiate separate and distinct growth responses and, when added together, produce a resultant of the two reactions.

The induction of growth by red radiant energy (660 $m\mu$) can be blocked by far-red energy (710–730 $m\mu$). Dr. Klein, Dr. R. B. Withrow, and Victor Elstad have found that the efficiency of the far-red is markedly increased by interposing a dark period of 60 to 90 minutes between the red and far-red treatments. This suggests that a thermochemical step intervenes between the absorption of red radiant energy and maximum capacity for inactivation by far-red. Reducing the temperature from 25° C. to 2° C. during the light treatments has no measurable effect on the induction process, but the lowered temperature reduces the maximum photoinactivation by 50 percent when compared to photoinactivation at 25° C. This substantiates the thesis of an intervening thermal step.

Phototropism.—There is a wide range of growth reactions activated by blue radiant energy, including cytoplasmic streaming, changes in cell-membrane permeabilities, the regulation of respiratory enzymes, changes in bioelectric potentials and phototropism or bending of plants toward a light source. The late Dr. E. S. Johnston of this laboratory became interested in phototropism in 1934 and made the first precise quantitative measurements of the spectral characteristics of the phototropic response in oats. From these data it was postulated that the pigment system activating the response absorbed chiefly in the blue and was likely to be a carotenoid or a flavin.

At the present time Walter Shropshire is conducting experiments to resolve the question of the identity of the photoreceptor by determining if the response occurs in the near-ultraviolet where the absorption of flavin is markedly greater than that of carotenoids. The results of *Avena*-tip-curvature experiments indicate that both pigment systems may be involved. The action spectrum in the visible has the peaks characteristic of carotenoid absorption, while in the near-ultraviolet the response is characteristic of a flavin system.

Experiments are in progress to ascertain the function of each of these pigment systems, using straight growth measurements of intact *Avena* seedlings and the curvature of carotenoid-deficient *Phycomyces*. An attempt is being made to correlate all the blue photoreg-

ulatory reactions to see if they are mediated by the same basic mechanisms.

A National Science Foundation grant for 3 years is supporting the major portion of the work at present.

Chloroplast development.—It has been found by Dr. J. B. Wolf and L. Price that radiant energy is necessary for the maturation of the chloroplast, the photosynthetic organ of the leaf of higher plants. The progress of this photomorphogenetic development has been followed by measuring the gradually increasing rate at which the leaf is able to synthesize chlorophyll when placed in high red or blue irradiances. In the leaf of a dark-grown seedling the rate of chlorophyll formation is at first very slow, but after two or three hours of high-intensity irradiation, the rate begins to increase. Therefore, the time lag before the leaf begins to form chlorophyll rapidly is taken as the time required for certain developmental changes in the proplastid as it is transformed into a functioning chloroplast.

Irradiation of dark-grown bean or corn leaves with a small amount of red energy (prior to incubation in the dark) has been found to be more effective than blue energy for stimulation of the ability to form protochlorophyll. Oxygen is required for the developmental processes, since it was noted that little or no chlorophyll is formed in an atmosphere of nitrogen. When the temperature at which the leaves are kept was lowered from 25° C. to 15° C., the metabolic processes necessary for synthesis of the chloroplast components are almost completely stopped; too high a temperature has a similar effect. These metabolic processes are being studied in greater detail.

Photoperiodic chlorosis.—Chlorophyll content of a number of plants is markedly influenced by the relative lengths of the light and dark periods. The leaves of young plants often show a marked chlorosis, with a definite pattern of interveinal yellowing when given long light periods in a 24-hour cycle. Often associated with the mottling are nastic responses, very similar to those occurring with certain types of virus infection. Temperature is closely correlated with light in influencing this process. At some temperatures, the plants are yellow and at others green, regardless of the photoperiod. Particularly does a cyclic alternation in temperature promote or inhibit the chlorosis under light conditions where the converse is true at constant temperatures. This type of chlorophyll deficiency has not been observed in plants growing under outdoor or greenhouse conditions with daylight, but seems to be a response unique to irradiation with artificial sources, particularly the incandescent lamp. Dr. Alice Withrow and Walter Shropshire this year have found that the far-red is the region of the spectrum which most effectively promotes the chlorosis. Far-red also promotes a very marked lengthening of the stem.

Modification of X-ray damage by visible radiant energy.—The damaging effects of X-rays and other forms of ionizing radiation to living cells are due chiefly to the breaking of the chromosomes and interference with normal cell division. Young, rapidly dividing cells are most susceptible to X-ray damage and evidence three types of aberrations—chromatid break, isochromatid break, and chromatid exchange.

It has previously been reported that far-red radiant energy, when used as a treatment supplementary to X-rays, increases the frequency of chromatid aberrations. This year, Dr. C. C. Moh and Dr. R. B. Withrow have extended the study on the interaction between red and far-red radiant energy at the level of the cell nucleus.

Root tips of broad bean (*Vicia faba*) were pretreated with a 3-hour exposure of red (620–680 $m\mu$) and/or far-red and near infrared (710–960 $m\mu$) radiant energy, and then irradiated with 120 roentgens of X-rays. As compared with the control (X-rays only), root tips receiving far-red treatment yielded 30 to 40 percent more chromatid breaks and chromatid exchanges. Those receiving far-red followed by red energy showed no appreciable increase in aberrations. These results indicate that red radiant energy inactivates the action of the far-red exposure. In a second series of experiments, root tips were irradiated with red energy for 3 hours, followed by a 3-hour exposure to far-red energy. As compared to the control, the red plus far-red treatment resulted in an increase of chromatid breaks and chromatid exchanges amounting to about 20 percent. It would appear that application of far-red energy after the red treatment could not completely overcome the inactivating effect of the red. In a third series, root tips were exposed for 3 hours to red and far-red energy simultaneously by using a broad waveband from 620 to 960 $m\mu$. No increase in any type of chromatid aberration was found.

PUBLICATIONS

- KLEIN, W. H., WITHROW, R. B., and ELSTAD, V. The response of the hypocotyl hook of bean seedlings to radiant energy and other factors. *Plant Physiol.*, vol. 31, pp. 289–294, 1956.
- KLEIN, W. H., WITHROW, R. B., ELSTAD, V., and PRICE, L. Photocontrol of growth and pigment synthesis in the bean seedling as related to irradiance and wavelength. *Amer. Journ. Bot.*, vol. 44, pp. 15–19, 1957.
- KLEIN, W. H., WITHROW, R. B., WITHROW, ALICE P., and ELSTAD, V. Time course of far-red inactivation of photomorphogenesis. *Science*, vol. 125, pp. 1146–1147, 1957.
- WITHROW, ALICE P., and WOLFF, J. B. Succinate oxidation by mitochondrial preparations from bean seedlings. *Physiologia Plantarum*, vol. 9, pp. 339–343, 1956.
- WITHROW, R. B. An interference-filter monochromator system for the irradiation of biological material. *Plant Physiol.*, vol. 32, pp. 355–360, 1957.

- WITHROW, R. B., and MOH, C. C. Nonionizing radiant energy as an agent in altering the incidence of X-ray-induced chromatid aberrations. I, Effects of far-red and infrared radiant energy on *Tradescantia* and *Vicia*. *Radiation Res.*, vol. 6, pp. 491-500, 1957.
- WITHROW, R. B., and PRICE, L. A darkroom safelight for research in plant physiology. *Plant Physiol.*, vol. 32, pp. 244-248, 1957.
- WITHROW, R. B., and WITHROW, ALICE P. Generation, control and measurement of visible and near-visible radiant energy. In "Radiation Biology," vol. 3, pp. 125-259. McGraw-Hill Book Co., 1956.

OTHER ACTIVITIES

Papers on the research in progress were presented during the past year at several international and national science meetings. At the annual meeting of the American Society of Plant Physiologists at Storrs, Conn., the following papers were given:

- Elimination of the lag phase of chlorophyll synthesis in dark-grown bean leaves by a pretreatment with low irradiances of monochromatic energy, by R. B. Withrow, J. B. Wolff, and L. Price.
- The action spectrum and kinetics of far-red blocking of the red-induced opening of the hypocotyl hook of bean, by W. H. Klein, R. B. Withrow, and V. Elstad.
- The role of chlorophyllase in the synthesis of chlorophyll *a* in higher plants, by J. B. Wolff and L. Price.

At a meeting of the Southern Section of the American Society of Plant Physiologists at Birmingham, Ala., R. B. Withrow gave a paper entitled "Action Spectrum and Photomorphogenesis in Higher Plants," and at the Midwest Section at Ann Arbor, Mich., W. H. Klein participated in a round-table discussion on "Effects of Light Quality on Plant Development." At the International Photobiology Conference at Turin, Italy, and the International Photoperiodism Congress at Parma, Italy, R. B. Withrow discussed the current research of the laboratory. R. B. Withrow and Walter Shropshire attended the national organizational meeting of the Biophysical Society held at Columbus, Ohio.

During the year, R. B. Withrow served as consultant to the Office of the Commanding General, U. S. Air Forces in Europe, and also as consultant to the Argonne National Laboratory. He was appointed chairman of the International Symposium on Photoperiodism in Plants and Animals, sponsored by the National Research Council, which is to be held at Gatlinburg, Tenn., in the fall of 1957.

Respectfully submitted.

F. L. WHIPPLE, *Director.*

Dr. LEONARD CARMICHAEL,
Secretary, Smithsonian Institution.

Report on the National Collection of Fine Arts

SIR: I have the honor to submit the following report on the activities of the National Collection of Fine Arts for the fiscal year ended June 30, 1957:

SMITHSONIAN ART COMMISSION

The 34th annual meeting of the Smithsonian Art Commission was held in the Regents Room of the Smithsonian Building on Tuesday, December 4, 1956. Members present were: Paul Manship, chairman; Robert Woods Bliss, vice chairman; Leonard Carmichael, secretary; John Nicholas Brown, Gilmore D. Clarke, David E. Finley, Lloyd Goodrich, Bartlett H. Hayes, Stow Wengenroth, Archibald G. Wenley, Andrew Wyeth, and Mahonri Young. Thomas M. Beggs, Director, and Paul Vickers Gardner, curator of ceramics, National Collection of Fine Arts, were also present.

Mr. Bliss, Mr. Goodrich, and Mr. Hayes commented favorably upon the progress of the Smithsonian Traveling Exhibition Service and its satisfactory relationship to other organizations in respect to the circulation of exhibitions. Mr. Beggs stated that when funds are available it will be desirable for the National Collection of Fine Arts to organize for circulation exhibitions combining artistic and scientific material from Smithsonian collections. It was reported that, although Department of State contracts had been vital to the Service initially, these have diminished in size and the Service is now self-supporting.

A resolution on the death of Lawrence Grant White, a member of the Commission from 1950 to the time of his resignation March 2, 1956, was read and unanimously adopted.

The chairman stated that the field of architecture was unrepresented on the Commission for a term expiring in 1959, owing to the resignation of Mr. White. The Commission then recommended to the Board of Regents the name of Douglas Orr to fill the vacancy.

The Commission also recommended the reappointment of David E. Finley, Paul Manship, Charles H. Sawyer, and Archibald Wenley, for the usual 4-year period.

The following officers were elected for the ensuing year: Paul Manship, chairman; Robert Woods Bliss, vice chairman; and Leonard Carmichael, secretary.

Dr. Finley, chairman of the executive committee, reported that this committee had not met during the year.

The following were reelected members of the executive committee for the ensuing year: David E. Finley, chairman; Robert Woods Bliss, Gilmore D. Clarke, and George Hewitt Myers. Paul Manship, as chairman of the Commission, and Leonard Carmichael, as secretary, are *ex officio* members.

The Commission recommended acceptance of the following objects:

Oil, *The Dog Trader*, by Richard N. Brooke (1847-1920). Gift of Col. Thomas G. Young, Jr.

Two watercolors, *Emergence and Tulips*, by Andrey Avinoff (1884-1949), were accepted on condition that they be held until eligible for consideration of the accessions committee of the National Gallery of Art. Gift of Mrs. Elizabeth Shoumatoff.

Oil, *Furbelows*, by Albert Sterner, N. A. (1863-1946). Henry Ward Ranger Bequest.

Oil, *Days of Sunshine*, by William Wendt, A. N. A. (1865-1946). Henry Ward Ranger Bequest.

Three etchings, by Carl Oscar Borg (1879-1947): *On the Rim, Grand Canyon, Arizona*; *The Chief's House, Moenkopi, Arizona*; and *Under Western Skies*. Anonymous gift.

Miniature, *Young Gentleman*, by John Alexander MacDougall (1810-1894). Gift of Henry L. Milmore.

A collection of 59 fans, 18th and 19th centuries, mostly French and English. Gift of Henry L. Milmore.

A 19th-century copy of the *Portland Vase*, by Wedgwood, England. Gift of Paul A. Straub.

The following 59 paintings, as bequeathed by Mabel Johnson Langhorne (oils on canvas unless otherwise indicated):

Madonna, by Biagio di Bindo Albertinelli (1474-1515). (Tempera on wood.)

Large Landscape, by Thomas Barker (1769-1847).

Small Landscape, by Thomas Barker (1769-1847). (Oil on wood.)

Duke of Sussex, by Sir William Beechey (1753-1839).

Dutch Gentleman, by Ferdinand Bol (1616-1680).

Christ Addressing the People, by Bonifazio Veronese (1490/1-1540).

Small Landscape, by Richard Parkes Bonington (1801-1828).

Landscape, by John Constable (1776-1837).

Small Landscape, by John Constable (1776-1837).

Windmill, by John Constable (1776-1837).

Small Landscape, by John Crome (Old Crome) (1768-1821).

Edmund Waller (1606-1687), by William Dobson (1610-1646).

Young Girl, by Willem Drost (16??-16??).

Landscape, by Thomas Gainsborough (1727-1788).

Small Landscape, by Thomas Gainsborough (1727-1788).

Head of Christ, by follower of Giorgione (1477/8-1510/1). (Tempera on wood.)

Scene in Venice, by Francesco de Guardi (1712-1793).

Venetian Scene, by Francesco de Guardi (1712-1793).

Small Landscape, by Francesco de Guardi (1712-1793). (Oil on wood.)

Irish Gentleman, by John Hoppner (1758-1810).

Gentleman, by John Jackson (1778-1831).

Prince Henry of Wales, by Cornelius Janssens van Ceulen (1593/4-1662/4).

Portrait of Rubens' Wife, by Jakob (Jacques) Jordaens (1593-1678).

- Gentleman, by Sir Godfrey Kneller (1646-1723).
 Barnyard Scene, by Robert Ladbrooke (1768/70-1842).
 Self-portrait, by Sir Thomas Lawrence (1769-1830).
 Viscountess Hatton, by Sir Peter Lely (1618-1680).
 Festive Scene, by Jan Miense Molenaer (1605/10-1668). (Oil on wood.)
 Ralph Cross Johnson (1843-1923), by Ernest Moore.
 Fishing Boats Beating up to Windward, by Edward Moran (1829-1901).
 Judith van Volbergen, by Paulus Moreelse (1571-1638).
 Small Landscape, by John Francis Murphy (1853-1921).
 Landscape, by John Francis Murphy (1853-1921).
 Portrait of a Boy, by Sir Henry Raeburn (1756-1823).
 Portrait of a Gentleman, by Sir Henry Raeburn (1756-1823).
 Lady in White, by Sir Joshua Reynolds (1723-1792).
 Lord Lifford, by Sir Joshua Reynolds (1723-1792).
 Lord Roth, by Sir Joshua Reynolds (1723-1792).
 Richard Brinsley Cheridan, by Sir Joshua Reynolds (1723-1792).
 Old Man, by Jusepe (Giuseppe) Ribera (1588/90-1652/6).
 Interior of New College, Oxford, by David Roberts (1796-1864).
 Rouen Cathedral, by David Roberts (1796-1864). (Oil on wood.)
 The Doctor's Visit, by Jan Havicksz Steen (1626?-1679).
 Landscape with Figures, by Jacobus van Strij (1756-1815).
 Mrs. Price, by Sir James Thornhill (1675-1734).
 Baptism of Christ, School of Giovanni Battista Tiepolo (1693/6-1770).
 (Oil on wood.)
 Woman Taken in Adultery, School of Giovanni Battista Tiepolo (1693/6-1770).
 Head of an Old Man, attributed to Benvenuto di Piero Tisi (called Garofalo) (1481-1559), formerly attributed to Leonardo da Vinci (1452-1519).
 (Tempera on wood.)
 Sir William Boothby, by undetermined artist (formerly attributed to Sir Joshua Reynolds).
 Mrs. Lloyd, by undetermined artist, after Reynolds.
 Marine, by undetermined artist.
 Virgin and Child with Apple, by undetermined artist. (Tempera on wood.)
 Adoration of the Kings, by Bernard Van Orley (1485/93-1542). (Tempera on wood.)
 Landscape by John Varley, Sr. (1778-1842). (Watercolor on paper.)
 Small Landscape, by John Varley, Sr. (1778-1842). (Watercolor on paper.)
 Entombment, by Rogier van der Weyden (1399/1400-1464). (Tempera on wood.)
 Italian Landscape, by Richard Wilson (1714-1782).
 Italian Landscape, by Richard Wilson (1714-1782).
 Landscape, by Richard Wilson (1714-1782).

A bronze bust of Gen. Winfield Scott Hancock, by James Wilson Alexander MacDonald (1824-1908), declined for the National Collection of Fine Arts, was recommended for acceptance by the United States National Museum, to be assigned to the Division of Military History for possible use in the new Museum of History and Technology. Offered by Mrs. Griffin de Mauduit through Mrs. James L. Collins, Jr.

THE CATHERINE WALDEN MYER FUND

Six miniatures, watercolor on ivory, were acquired from the fund established through the bequest of the late Catherine Walden Myer as follows:

106. David McClellan (1773-1820), attributed to Benjamin Trott (ca.1770-ca.1841).

107. Christopher Burdick (1789-1833), by undetermined artist.

108. Mrs. Christopher Burdick, née Lydia Easton (1796-1881), by undetermined artist.

Nos. 106 through 108 were acquired from Mrs. Janet W. Yates, Washington, D. C.

109. Unknown Gentleman, by George W. Newcombe (1799-1845).

110. TS in Blue Coat, by undetermined artist.

Nos. 109 and 110 were acquired from Mr. A. C. Mayer, Washington, D. C.

111. Col. Josiah Parker (1751-1810), by Charles Willson Peale (1741-1799); from Mrs. Sue C. Bunch, Washington, D. C.

WITHDRAWAL BY OWNERS

Oil, Maid of the Mist, by Thomas Cole, lent October 6, 1942, by Mrs. L. T. Gager, Washington, D. C., was withdrawn by the owner.

Oil, George Washington, by Charles Willson Peale, returned as a loan December 4, 1956, by the estate of Mrs. John S. Beck, was withdrawn by order of Oscar J. See, the executor, on March 28, 1957.

ART WORKS LENT

The following art works, oil paintings on canvas unless otherwise noted, were lent for varying periods:

To the Bureau of the Budget, Washington, D. C.:

August 7, 1956----- Huichol Indian, by Anton Sario.

In the Studio, by Arnoldo Tamburini.

September 21, 1956----- The Wanderluster's Rest, by William H. Holmes.
The South Strand, by Emil Carlsen.

January 23, 1957----- The Wain Team, by George Elmer Browne.
President John Tyler, by G. P. A. Healy.

Fisher Girl of Picardy, by Elizabeth Nourse.

Linlithgan Bridge, by Richard M. Stevenson.

March 19, 1957----- George Catlin, by William Fisk.

Daniel Chester French, by Evelyn Beatrice Longman. (Bronze bas relief.)

To the U. S. Court of Military Appeals, Washington, D. C.:

August 10, 1956----- Summer, by Charles Harold Davis.

Abraham Lincoln, by Henry Kirke Bush-Brown.
(Bronzed plaster bust and pedestal.)

February 6, 1957----- Evening Tide, California, by William Ritschel.

Gen. Winfield Scott Hancock, by James W. A. MacDonald. (Bronze bust and pedestal.)

April 18, 1957----- The First Gun at Fort Sumter, by Alban Jasper Conant.

To The White House, Washington, D. C. :

- August 15, 1956----- Roseate Spoonbills, by Abbott H. Thayer.
Male Wood Duck, by Richard S. Meryman.
- January 14, 1957----- Early Summer, by Charlotte B. Coman. (Returned
January 30, 1957.)
Evening Tide, California, by William Ritschel.
(Returned January 30, 1957.)

To the Department of State, Washington, D. C. :

- August 15, 1956----- Tomb of "Mahomet the Gentleman" at Broussa, by
Osman Edhem Hamdy Bey.
- November 19, 1956----- View of Constantinople from Pera, by an unde-
termined artist.
- January 22, 1957----- Spring, Navesink Highlands, by Childe Hassam.
End of Winter, by John Henry Twachtman.
- March 14, 1957----- The Torrent, by John Henry Twachtman.
Niagara, by George Inness.
Autumn at Arkville, by Alexander H. Wyant.
- March 21, 1957----- The Blockmaker, by Edgar Melville Ward.

To the Dallas Museum of Fine Arts, Dallas, Tex., for an "Exhibition of Presidents":

- September 5, 1956----- U. S. Grant, by Thomas LeClear.
William Howard Taft, by Alyn Williams. (Miniature,
watercolor on ivory.)
John Tyler, by George P. A. Healy.
George Washington, by Henry Bounetheau, after
Stuart. (Miniature, watercolor on ivory.)
George Washington, by Henry Bounetheau, after
Trumbull. (Miniature, watercolor on ivory.)
Woodrow Wilson, by Edmund Tarbell.
(All were returned December 13, 1956.)

To the National Air Museum, Washington, D. C., portraits (sanguine chalk on paper unless otherwise noted) of members of the Lafayette Escadrille, by John Elliott (1858-1925) :

- October 16, 1956----- Victor Emmanuel Chapman.
Richard Stevens Conover, 2d.
Hamilton Coolidge.
Elliott Christopher Cowden.
Edmond Charles Clinton Genet.
Bert Hall.
Gervais Raoul Lufbery.
James R. McConnell.
Richard Norton.
Paul Pavelka.
Norman Prince.
Philip Rhineland.
Quentin Roosevelt.
Alan Seeger.
William Thaw.
Georges Thenault.
Raynal Cawthorne Bolling.*
William Halsall Cheney.*
Richard McCall Elliott, Jr.*
Kiffin Yates Rockwell.*

*Sepia prints.

To the Department of Justice, Washington, D. C.:

October 18, 1956----- William C. Preston, by George P. A. Healy.
New Year's Shooter, by George Luks.
Henry Ward Ranger, by Albert Neuhuys.
Thomas McKean, by Charles Willson Peale.
La Vachère, by Theodore Robinson.
The Inn, Germany, by Walter Shirlaw.
Infant Christ with Cross and Torch, by undetermined artist.

February 14, 1957----- Early Summer, by Charlotte Buell Coman.
Un Brave—French Soldier, by Lucie Louise Fery.
The Watering Place, by Louis Paul Dessar.
Rev. George Heaton, M. A., by Edward Heaton.
Self Portrait, by Will H. Low.
Musa Regina, by Henry Oliver Walker.
Manifest Destiny—Buffalo, by Edward Kemeys.
(Bronzed plaster.)
Grizzly Bear, Seated, by Edward Kemeys.
(Bronzed plaster.)

May 23, 1957----- Life Saving Patrol, by Edward Moran.

To the National Gallery of Art, Washington, D. C., for photographing:

October 29, 1956----- Thomas Hopkinson, by Robert Feke. (Returned
October 31, 1956.)

To the Interstate Commerce Commission, Washington, D. C.:

November 6, 1956----- Early Spring, by Alexander T. Van Laer.
Idle Hours, by Harry S. Mowbray.
Study Head, Madam Capri, by Walter Shirlaw.
Among the Old Poets, by Walter Shirlaw.
Walter Shirlaw, by Frank Duveneck.

January 7, 1957----- November, by Jervis McEntee.
Adieu, by Salvatti Aly.

To the Department of the Interior, Washington, D. C.:

November 7, 1956----- A Pool in the Forest, by Benjamin Rutherford
Fitz. (Returned June 13, 1957.)
Housatonic Valley, by Alexander Wyant. (Re-
turned June 13, 1957.)

To the Corcoran Gallery of Art, Washington, D. C., for the 25th Biennial Exhibition of Contemporary American Oil Paintings, January 13 through March 10, 1957:

January 3, 1957----- Caresse Infantine, by Mary Cassatt. (Returned
May 23, 1957.)
The Island, by Edward W. Redfield. (Included
with exhibition shown at the Toledo Museum of
Art, April 1-30, 1957, and to be circulated by the
American Federation of Arts through September
30, 1958.)

To the Corcoran Gallery of Art, Washington, D. C., for an exhibition of Presidential Portraits, March 19 to September 1, 1957:

March 13, 1957----- Self Portrait, by George P. A. Healy.

To the Virginia Museum of Fine Arts, Richmond, Va., for an exhibition, "The Tastemakers," January 18 through February 24, 1957:

January 4, 1957----- Fired On, by Frederic Remington. (Returned
March 5, 1957.)

To the Pan American Union, Washington, D. C.:

January 15, 1957----- African Elephant Scenting Danger, by Eli Harvey.
(Bronze.) (Returned January 23, 1957.)

To the Federal Communications Commission, Washington, D. C.:

April 26, 1957----- Beach of Bass Rocks, Gloucester, Massachusetts,
by Frank K. M. Rehn.
The White Parasol, by Robert Reid.
Furbelows, by Albert Sterner.

To the United States District Court for the District of Columbia, Washington,
D. C.:

May 16, 1957----- Henry B. Fuller, by George Fuller.
The Villa Malta, by Sanford R. Gifford.
The Gathering Storm, by Louis Gabriel Eugène
Isabey.

May 31, 1957----- Captain John Ericsson, by Arvid Nyholm.
Gathering Mists, by Charles Warren Eaton.
An Abbess, by Govaert Camphuysen.
Eucalyptus Tree, by A. Ames.
Pepper Tree, by A. Ames.
A Bodhisattva, Cave 4, Bagh, by Sarkis Katcha-
dourian. (Watercolor.)
Bear Standing on a High Rock, by Edward Kemeys.
(Bronzed plaster.)

To Conrad V. Morton, Department of Botany, U. S. National Museum, for display
at the Arts Club:

June 19, 1957----- Unknown Man, by Henry Dexter. (Plaster.)
(Returned June 26, 1957.)

To the Civil Service Commission, Washington, D. C.:

June 21, 1957----- A Pool in the Forest, by Benjamin Rutherford Fitz.
Housatonic Valley, by Alexander H. Wyant.

LOANS RETURNED

Table, French, 18th century (P. 220), lent August 21, 1953, to the
American Institute of Architects, was returned December 6, 1956.

Oil, Capt. John Ericsson, by Arvid Nyholm, lent March 3, 1950, to
the House Judiciary Committee, was returned December 28, 1956.

Two oils, Cliffs of the Upper Colorado River, Wyoming Territory,
by Thomas Moran, and Mary Abigail Willing Coale, by Thomas
Sully, lent December 6, 1955, to the Smithsonian Traveling Exhibi-
tion Service to be included in an exhibition "Pennsylvania Painters,"
were returned January 30, 1957.

Oil, The Continentals, by Frank B. Mayer, lent October 28, 1953,
to the Department of State, was returned May 8, 1957.

SMITHSONIAN LENDING COLLECTION

Six oils, Building the United Nations, by Harold Weston (1894-),
gift of the Committee of the Weston United Nations Paintings, Mrs.
William S. Ladd, Chairman, were accepted December 6, 1955, with a
fund of \$2,500. The paintings were lent to the Corcoran Gallery of
Art on April 9, 1956, and were returned October 8, 1956.

Oil, Episode of the Siege of Lille, 1792, by Gaston Melingue (1840-1914), gift of Thomas G. Young, Jr., was added December 4, 1956.

Oil, Shapes of Fear, by Maynard Dixon (1875-1946), No. 98 in the Henry Ward Ranger Bequest, was added December 4, 1956, with the consent of the National Academy of Design.

Miniature, watercolor on ivory, copy of the Head of the Virgin from Raphael's "The Virgin with the Goldfinch," gift of Henry L. Milmore, was added December 4, 1956.

Tapestry, 17th century, Flemish verdure, gift of John B. Turner, was added December 4, 1956.

Two paintings, by Edwin Scott, Porte St. Martin et Enterrement, and Ship at Anchor, Cherbourg, No. 2, lent February 18, 1953, to the United States District Court for the District of Columbia, were returned May 31, 1957.

The following paintings, oil on canvas unless otherwise noted, were lent for varying periods:

To The White House, Washington, D. C.:

July 27, 1956----- Grand Canyon, by Carl Oscar Borg. (Returned August 15, 1956.)
Guard, by J. Echenal. (Watercolor.)
Moonlight on the Sea, by Frank W. Stokes.
Lady of Light, by undetermined artist.

To the Bureau of the Budget, Washington, D. C.:

August 7, 1956----- Street in the Pueblo of Zuñi, New Mexico, by De Lancey Gill. (Watercolor.)
October 24, 1956----- Grand Canyon, by Carl Oscar Borg.

To the Department of Justice, Washington, D. C.:

February 14, 1957----- Musketeer, by G. Camfri. (Watercolor.)

To the Federal Communications Commission, Washington, D. C.:

April 26, 1957----- Pueblo Bonita Ruin, by De Lancey Gill. (Watercolor.)
Italian Woman at the Foot of the Stairs, by Edwin Scott.
Smoke from the City, by Robert Burns Wilson. (Watercolor.)

To the United States District Court for the District of Columbia, Washington, D. C.:

May 16, 1957----- Tiger Lily, by Florence Koehler. (Gouache.)
May 31, 1957----- Piazza San Marco, by Henry Bacon. (Watercolor.)
George Bernard Shaw, by Alice Pike Barney. (Pastel.)
Alice (Alice Pike Barney), by L. A. Malempre. (Marble bust.)

ALICE PIKE BARNEY MEMORIAL FUND

Additions to the principal during the year amounting to \$662.30 have increased the total invested sums in this fund to \$37,090.52.

A gift of \$1,500 was received from Mrs. Laura Dreyfus-Barney in partial defrayment of the cost of printing a booklet, "Alice Pike

Barney: Paintings in Oil and Pastel," consisting of reproductions from the Lending Collection, given in memory of Alice Pike Barney.

THE HENRY WARD RANGER FUND

No. 36, *Midsummer*, by William S. Robinson, N. A. (1861-1945), purchased by the Council of the National Academy of Design April 7, 1924, was reassigned by the Academy to George Washington University, Washington, D. C., on March 1, 1956.

According to a provision in the Ranger bequest that paintings purchased by the Council of the National Academy of Design from the fund provided by the Henry Ward Ranger Bequest, and assigned to American art institutions, may be claimed during the 5-year period beginning 10 years after the death of the artist represented, the following four paintings were recalled for action of the Smithsonian Art Commission at its meeting December 4, 1956:

No. 59, *Days of Sunshine*, by William Wendt, A. N. A. (1865-1946), assigned to the Malden Public Library, Malden, Mass., in 1926, was accepted to become a permanent accession.

No. 72, *The Golden Hour*, by George Elmer Browne, N. A. (1871-1946), was returned to the Michigan State College of Agriculture and Applied Science, East Lansing, Mich., where it was originally assigned in 1929.

No. 98, *Shapes of Fear*, by Maynard Dixon (1875-1946), assigned to the Brooklyn Institute of Arts and Sciences, The Brooklyn Museum, Brooklyn, N. Y., in 1932, was reassigned, with permission of the National Academy of Design, to the Smithsonian Lending Collection.

No. 119, *Furbelows*, by Albert Sterner, N. A. (1863-1946), assigned to St. Gregory College, Shawnee, Okla., in 1942, was accepted to become a permanent accession.

The following paintings, purchased by the Council of the National Academy of Design since the last report, have been assigned as follows:

| <i>Title and Artist</i> | <i>Assignment</i> |
|---|---|
| 180. <i>Mansion in Dutchess County</i> , by Hobson Pittman, N. A. (1900-) | Museum of Cranbrook Academy of Art, Bloomfield Hills, Mich. |
| 181. <i>Attic Windows</i> , by Charles Taylor (1911-) | Montclair Art Museum, Montclair, N. J. |
| 182. <i>Demolition</i> , by Harry Leith Ross, N. A. (1886-) | Pennsylvania Academy of Fine Arts, Philadelphia, Pa. |
| 183. <i>Picnic Along the Brook</i> , by John E. Costigan, N. A. (1888-) | Agnes Scott College, Decatur, Ga. |
| 184. <i>Ruined Cathedral (watercolor)</i> , by Ralph Hulett (1915-) | The Andrew Dickson White Museum of Art, Cornell University, Ithaca, N. Y. |
| 185. <i>At Home (watercolor)</i> , by Walter Biggs, N. A. (1886-) | Oklahoma Art Center, Oklahoma City, Okla. |
| 186. <i>Quince Street (watercolor)</i> , by W. Emerton Heitland, N. A. (1893-) | (Not yet assigned.) |
| 187. <i>Toward Evening</i> , by Junius Allen, N. A. (1898-) | Columbia Museum of Art, Columbia, S. C. |

SMITHSONIAN TRAVELING EXHIBITION SERVICE

Eighty-six exhibitions were circulated and shown in 198 museums and galleries during the past season, 81 in the United States and 5 abroad, as follows:

UNITED STATES

Paintings and Drawings

| <i>Title</i> | <i>Source</i> |
|--|--|
| American Indian Painting----- | Philbrook Art Center, Tulsa, Okla. |
| A Century and a Half of Painting in Argentina. | Government of Argentina; Argentine Embassy; private collectors. |
| Argentine Children as Illustrators-- | Editorial Guillermo Kraft Ltd., Buenos Aires; Argentine Embassy. |
| As I See Myself----- | <i>Arts & Activities Magazine</i> ; Galerie St. Étienne. |
| Art in Opera----- | Metropolitan Opera Guild. |
| California Painting----- | Long Beach Museum of Art, Long Beach, Calif. |
| Canadian Abstract Paintings----- | National Gallery of Canada, Embassy of Canada. |
| Children's Paintings from Forty- five Countries IV. | } Embassy of Denmark; Friendship Among Children and Youth Organization. |
| Children's Paintings from Forty- five Countries V. | |
| Children's Paintings from Forty- five Countries VI. | |
| Children's Paintings from Japan--- | |
| Dutch Art 1945-55 (and sculpture) _ | United Nations Educational, Scientific, and Cultural Organization. Dr. W. Sandberg, Stedelijk Museum; Mr. E. L. de Wilde, Van Abbe Museum; Mr. A. M. Hammacher, Kröller-Müller State Museum; Embassy of the Neth- erlands. |
| Ethiopian Paintings----- | George Washington University; Mr. Bruce Howe; Embassy of Ethiopia. |
| A Frenchman in America, Charles Alexandre Lesueur. | Museum of Le Havre; American Em- bassy in Paris. |
| Six Japanese Painters----- | National Museum of Modern Art, Tokyo; artists. |
| Kokoschka's Magic Flute----- | Minneapolis Institute of Arts; artist; Embassy of Austria. |
| Pennsylvania Painters----- | Pennsylvania State University, State College; museums; private collectors. |
| Plant Portraits----- | University of Colorado Museum, Boulder. |
| Work by Rudy Pozzatti (and prints). | Print Club of Cleveland; Cleveland Mu- seum of Art; dealers; private col- lectors. |
| Sargent Watercolors----- | Museum of Fine Arts, Boston. |
| Seal Islands----- | Cleveland Museum of Natural History. |
| Watercolor Today----- | Toledo Museum of Art; dealers; artists. |
| Contemporary Swedish Paintings---- | National Museum, Stockholm; Swedish Embassy. |

Paintings and Drawings—Continued

| <i>Title</i> | <i>Source</i> |
|-----------------------------------|--|
| Swedish Children's Paintings----- | National Museum, Stockholm; Swedish Embassy. |
| Paintings by Tessai----- | Kokusai Bunka Shinkokai; National Museum of Modern Art, Tokyo; Ki-yoshi Kojin Temple in Takarazuka; Rev. Bishop Kojo Sakamoto. |

Graphic Arts

| | |
|-------------------------------------|---|
| American Printmakers----- | University of Illinois, Urbana; artists. |
| George Bellows Prints and Drawings. | National Gallery of Art; Boston Public Library; Library of Congress; Fogg Art Museum of Harvard University. |
| Recent British Lithographs----- | British Arts Council; British Embassy. |
| Contemporary German Prints----- | National Gallery of Art. |
| Japanese Fish Prints----- | Dr. Yoshio Hiyama; Kokusai Bunka Shinkokai; Japanese Embassy; American Museum of Natural History. |
| Japanese Woodcuts I----- | United Nations Educational, Scientific, and Cultural Organization; Japanese National Commission. |
| Japanese Woodcuts II----- | |

Architecture

| | |
|--|--|
| A Half-Century of Architectural Education. | School of Architecture, Georgia Institute of Technology. |
| Architectural Photography I----- | American Institute of Architects; Architectural Photographers Association; George Eastman House. |
| Architectural Photography II----- | |
| Contemporary Danish Architecture... | Prof. Kay Fisker, Royal Academy of Copenhagen; Embassy of Denmark. |
| Contemporary Finnish Architecture... | Finnish American Society; Association of Finnish Architects; Embassy of Finland. |
| German Architecture Today----- | Bund Deutscher Architekten; German Embassy. |
| Landscape Architecture Today----- | California Redwood Association. |
| New Libraries----- | American Institute of Architects. |
| San Francisco Bay Region Architecture. | California Redwood Association; Northern California Chapter, American Institute of Architects. |
| Venetian Villas I----- | Soprintendenza ai Monumenti Medievali e Moderni, Venice; Embassy of Italy. |
| Venetian Villas II----- | |

Design

| | |
|---|--|
| American Craftsmen, 1957----- | Mr. Robert von Neumann; University of Illinois, Urbana; artists. |
| American Craftsmen II----- | University of Illinois, Urbana; artists. |
| Contemporary American Glass----- | Corning Museum of Glass. |
| American Jewelry and Related Objects I. | Huntington Galleries, Huntington, W. Va.; artists; Hickok Co. |

Design—Continued

| <i>Title</i> | <i>Source</i> |
|--|--|
| American Jewelry and Related Objects II. | Rochester Memorial Art Gallery, Rochester, N. Y.; artists; Hickok Co. |
| Recent Work by Harry Bertoià_____ | Knoll Associates; artist. |
| Contemporary European Tapestry__ | Contemporary Arts Association, Houston, Tex.; artists; private collectors; museums. |
| Dutch Arts and Crafts_____ | Ministry of Education, Arts and Sciences in The Hague; Netherlands Embassy. |
| European Glass Design_____ | Georg Jensen, Inc.; designers. |
| Fifty Years of Danish Silver_____ | Georg Jensen, Inc.; Danish Embassy. |
| Finnish Crafts_____ | Waertsila-Arabia and other Finnish Manufacturers; Finnish-American Society, Helsinki; Finnish Embassy; artists, Tapio Wirkkala and Rut Bryk. |
| Italian Arts and Crafts_____ | Compagnia Nazionale Artigiana, Rome; Italian Embassy. |
| Midwest Designer-Craftsmen_____ | Art Institute of Chicago; artists. |
| New England Crafts_____ | Worcester Art Museum; Junior League of Worcester, Inc.; The Craft Center, Worcester, Mass. |
| Good Design in Switzerland_____ | Schweizer Werkbund; Embassy of Switzerland. |

Books

| | |
|-------------------------------------|---|
| German Art Books_____ | Association of German Booksellers; German Embassy. |
| International Children's Books_____ | Washington Post Times-Herald Book Fair; embassies. |
| Sixty Swedish Books_____ | Dr. Uno Willers, Royal Library of Stockholm; Embassy of Sweden. |
| A World of Children's Books_____ | Washington Post Times-Herald Book Fair; embassies. |

Oriental Art

| | |
|--|-----------------------------|
| Chinese Ivories from the Collection of Sir Victor Sassoon. | Sir Victor Sassoon, London. |
|--|-----------------------------|

Folk Art

| | |
|---------------------------------------|--|
| Americana_____ | Index of American Design, National Gallery of Art. |
| Early American Woodcarving_____ | Index of American Design, National Gallery of Art. |
| Eskimo Art III_____ | Eskimo Art, Inc.; Canadian Handicrafts Guild. |
| Popular Art in the United States_____ | Index of American Design, National Gallery of Art. |
| Punch and Judy_____ | Index of American Design, National Gallery of Art. |
| Scrimshaw Exhibition_____ | Colonel Leslie Buswell. |

Folk Art—Continued

| <i>Title</i> | <i>Source</i> |
|--|---|
| Swiss Peasant Art..... | R. Hanhart, Director, Museum, St. Gall; Pro Helvetia Foundation; Embassy of Switzerland. |
| Ansel Adams Photographs 1933- 1953. | Artist; George Eastman House, Roches- ter. |
| Birds in Color, by Eliot Porter..... | Artist; American Museum of Natural History. |
| Japan I, by Werner Bischof..... | Magnum Photos, Inc. |
| Japan II, by Werner Bischof..... | Magnum Photos, Inc. |
| Perceptions..... | Mrs. Dody Warren Weston and Donald Ross; San Francisco Museum of Art; photographers. |
| This is the American Earth..... | Ansel Adams; Nancy Newhall; National Park Service; California Academy of Sciences; Sierra Club. |
| The World of Edward Weston..... | Beaumont and Nancy Newhall; artist; George Eastman House. |
| Young Germans Behind the Camera... | Dr. L. Fritz Gruber, Photokina, Cologne; German Embassy. |

Anthropology

| | |
|--|---|
| Carl Bodmer Paints the Indian Frontier. | Karl Viktor, Prinz zu Wied; German Embassy. |
| A. J. Miller Watercolors..... | Walters Art Gallery, Baltimore, Md. |
| Swedish Rock Carvings..... | Dr. Per Nyström, Governor of the Province of Göteborg and Bohus, Em- bassy of Sweden. |

EXHIBITIONS CIRCULATED ABROAD

John Marin.

This is the American Earth (4 copies).

INFORMATION SERVICE AND STAFF ACTIVITIES

In addition to the many requests for information received by mail and telephone, inquiries made in person at the office numbered 2,293. Examination was made of 836 works of art submitted for identification.

An illustrated and descriptive catalog, by Paul Vickers Gardner, entitled "Meissen and Other German Porcelain in the Alfred Duane Pell Collection," was published in July 1956.

An illustrated booklet, "Alice Pike Barney: Paintings in Oil and Pastel," with foreword by Thomas M. Beggs, was published in May 1957.

Special catalogs were published for the following 11 exhibitions: A Half-Century of Architectural Education; Contemporary Danish Architecture; Dutch Art 1945-1955; George Bellows Prints and Drawings; German Architecture Today; Sixty Swedish Books;

Swedish Rock Carvings; Canadian Abstract Paintings; German Art Books; Good Design in Switzerland, and Paintings by Tessai. The last four contained acknowledgments written by Mrs. Annemarie H. Pope, chief, Smithsonian Traveling Exhibition Service. Special acknowledgment for the Bellows catalog was written by Miss Jo Ann Sukel, research assistant.

Mr. Beggs gave a talk on 18th-Century Paintings before the Alexandria Woman's Club, and served on the juries of three local shows and one in Virginia. He was elected to the Board of Trustees of the Barney Neighborhood House.

Mr. Gardner gave illustrated lectures and conducted discussion groups on 18th-Century European and China-Trade Porcelains; European Porcelain for Colonial Tables; and Porcelain, Mirror of Fashion, at the Sulgrave and Senior Congressional Clubs in Washington, D. C., and at the Richmond Antiquarian Society and the Alexandria Association in Virginia. His review of "Ceramics for the Archeologist," by Anna O. Shephard, appeared in the May 1957 issue of the *Scientific Monthly*.

Between August 17, 1956, and March 29, 1957, Mrs. Pope represented the Traveling Exhibition Service on a visit to museums and galleries in Seattle, Wash.; Honolulu, T. H.; Tokyo, Kyoto, Nara, Japan; Taipei, Taichung, Taiwan; Hong Kong; Saigon, Viet-Nam; Phnom Penh, Siem-Réap (Angkor), Cambodia; Singapore; Djakarta, Djokjakarta, Surabaya, Indonesia; Bangkok, Chiangmai, Thailand; Rangoon, Burma; Calcutta, India; Frankfurt, Germany; Amsterdam, Holland; and London, England.

Mr. Lyon represented the National Collection of Fine Arts at a seminar on "Resinous Surface Coatings," held at Oberlin College, Oberlin, Ohio, under the auspices of the Intermuseum Conservation Association. He discussed the organization of art clubs, the planning of stimulating art meetings, and group art trips, for the Petworth Women's Club and the Port Tobacco Art Guild of Southern Maryland. He also judged two local exhibitions and one held at the Fairfax County Court House. On June 28, he left on a 2-month trip through western Europe, expecting to visit British, French, Italian, and Spanish Museums.

Fifty-five paintings in oil on canvas from the permanent collection were cleaned and revarnished, and 66 picture frames were repaired and refinished. Three plaster casts, one sculpture in wood, and one Italian chair were repaired.

The canvases of 9 paintings from the Smithsonian Lending Collection were cleaned, restored, and revarnished, and 12 frames were repaired and refinished.

Six paintings by George Catlin were cleaned, repaired, and revarnished, and two picture frames were refinished for the United States National Museum.

Under special contract, Glenn J. Martin began the cleaning and restoring of 12 paintings in the permanent collection.

SPECIAL EXHIBITIONS

Fifteen special exhibitions were held during the year:

August 23 through September 21, 1956.—The Second Biennial Exhibition of Creative Crafts, sponsored by the Ceramic Guild of Bethesda; Clay Pigeons of Kensington; Cherry Tree Designers; Designer-Weavers, and The Kiln Club of Washington, consisting of 113 pieces. Craft demonstrations were given twice daily. A catalog was privately printed.

October 7 through 28, 1956.—The Sixty-fourth Annual Exhibition of The Society of Washington Artists, consisting of 32 paintings and 18 pieces of sculpture. A catalog was privately printed.

November 3 through 25, 1956.—The Nineteenth Metropolitan State Art Contest, held under the auspices of the D. C. Chapter, American Artists Professional League, assisted by the Entre Nous Club, consisting of 203 paintings, sculpture, prints, ceramics, and metalcrafts. A catalog was privately printed.

December 2 through 24, 1956.—Paintings of Life in Greece, Spain, and the United States, by Demetrios J. Kokotsis, sponsored by His Excellency, The Ambassador of Greece, George V. Melas, consisting of 71 oil paintings and 65 sketches. A catalog was mimeographed.

December 9 through 24, 1956.—Contemporary Persian Miniature Paintings of Selected Quatrains of the Rubaiyat of Omar Khayyam, by Hossein Behzad, sponsored by His Excellency, the Ambassador of Iran and Madame Amini, consisting of 50 paintings.

January 6 through 27, 1957.—Twenty-first Exhibition of the Society of Washington Printmakers, consisting of 208 works in the graphic media. A catalog was privately printed.

February 5 through 28, 1957.—In cooperation with the Department of History, an exhibition, "Portraits in Plaster," consisting of 38 life and death masks and 9 busts of famous European and American statesmen, artists, musicians, and poets, mostly of the 18th and 19th centuries, from a collection assembled in 1929 by Henry C. McComas and presented to the United States National Museum. A mimeographed list was supplied.

March 10 through 29, 1957.—The Thirteenth Annual Exhibition of the Artists Guild of Washington, consisting of 50 paintings and 3 pieces of sculpture. A catalog was privately printed.

March 10 through 29, 1957.—The Tenth Annual Exhibition of the Washington Sculptors Group, consisting of 58 pieces of sculpture. A catalog was privately printed.

April 7 through 28, 1957.—Exhibition of Contemporary Paintings of Life in Pakistan, by Zainul Abedin under the sponsorship of His Excellency, the Ambassador of Pakistan and Begum Ali, consisting of 52 paintings. A catalog was privately printed.

April 14 through 28, 1957.—Exhibition of 115 color renderings, "500 Years of Turkish Tiles," by Captain Izzet Çetin; 14 photographs showing interiors and exteriors of buildings in Turkey which contained the tile of which the renderings

were made; three books of descriptive materials on Persian and Turkish tiles, and 15 tiles and 1 plate by a modern ceramist, Fureya, was held under the sponsorship of the Turkish Embassy. A leaflet was privately published.

May 5 through June 2, 1957.—The Sixtieth Annual Exhibition of the Washington Water Color Club, consisting of 157 watercolors, pastels, prints, and drawings. A catalog was privately printed.

May 5 through June 2, 1957.—The Twenty-fourth Annual Exhibition of the Miniature Painters, Sculptors, and Gravers Society of Washington, D. C., consisting of 183 examples. A catalog was privately printed.

June 8 through July 7, 1957.—Exhibition of 69 photographs of the Appalachian Trail and its activities, by members of the Potomac Appalachian Trail Club.

June 30 through July 7, 1957.—Exhibition of 33 Contemporary Paintings of Indonesia, by Derachman, sponsored by His Excellency, Moekarto Notowidigdo, Ambassador of the Republic of Indonesia. A catalog was privately printed.

Respectfully submitted.

THOMAS M. BEGGS, *Director.*

Dr. LEONARD CARMICHAEL,
Secretary, Smithsonian Institution.

Report on the Freer Gallery of Art

SIR: I have the honor to submit the thirty-seventh annual report on the Freer Gallery of Art, for the year ended June 30, 1957.

THE COLLECTIONS

Thirty-nine objects were added to the collections by purchase as follows:

BRONZE

- 56.15. Chinese, Han dynasty (207 B. C.—A. D. 220). Square ceremonial vessel of the type *hu*; decorated with human figures in hunting and legendary scenes cast in relief. 0.369 x 0.225.
- 56.19. Chinese, Shang dynasty (ca. 12th century B. C.). Ceremonial tripod of the type *chüeh* decorated with casting in relief; inscription of one character. 0.197 x 0.167.
- 56.26. Chinese, Shang dynasty. Ceremonial vessel of the type *p'an* decorated with casting in relief; inscription of one character. 0.121 x 0.325. (Illustrated.)
- 56.29. Chinese (Ordos), Han dynasty. Openwork plaque showing two fighting animals cast in relief and with incised decoration. 0.115 x 0.069.
- 56.31. Chinese, Shang dynasty. Battleax with decorations cast in low relief. 0.182 x 0.060.
- 57.12. Chinese, Sung dynasty (A. D. 960–1279). Eight-lobed mirror with silvery surface; decorated with phoenixes and cosmic symbols cast in relief; inscription of 40 characters. Diameter: 0.224.

GOLD

- 57.3. Persian, 11th–12th century. Ring decorated with turquoises, pearls, and designs in niello. 0.037 x 0.020.

JADE

- 56.16. Chinese, Early Chou dynasty (ca. 11th century B. C.). Large ceremonial perforated disk of the type *pi*; mottled green and brown nephrite. Diameter: 0.458.

LACQUER

- 57.8. Japanese, Kamakura period (A. D. 1192–1333). Seated image of Dai Nichi Niorai carved in wood and covered with gold lacquer, with gilt bronze crown, crystal eyes and *urna*, lotus throne. Overall: 0.735 x 0.505.

MANUSCRIPT

- 56.11. Armenian, 13th century. Gospel of 294 parchment leaves by the priest, Thoros, Monastery of Grner, Cilicia, A. D. 1263; black and gold text and 13 full-page paintings; modern binding. Average page: 0.204 x 0.150.

- 57.13. Iraq (Baghdad ?), second half 14th century. Leaf of a copy of Qazwini's 'Ajā'ib al Makhlūqāt ("Wonders of Creation"); miniature showing wild cattle. 0.327 x 0.230.
- 56.14. Persian, 16th century. Hātifi's *Haft Manzar* written by Mir 'Ali on 104 paper leaves of various colors; red leather binding with gold decoration. Overall: 0.262 x 0.168.

PAINTING

- 56.22. Chinese, Yüan dynasty (1260-1368). Bamboo in the snow, in ink on paper; by T'an Chih-jui; one inscription and one seal on painting. 0.314 x 0.206.
- 56.27. Chinese, Ch'ing dynasty (1644-1912). Landscape in ink and full color on paper; by Wang Chien; dated in correspondence with A. D. 1688; 1 inscription and 15 seals on painting. 1.355 x 0.625.
- 56.28. Chinese, Ming dynasty (1368-1644). Landscape in ink and color on paper; by Shen Chou; dated in correspondence with A. D. 1491; one inscription and five seals on painting. 1.125 x 0.598.
- 57.4. Chinese, Ch'ing dynasty (1644-1912). Landscape, "Peach-blossom Spring," after a story by T'ao Ch'ien; in ink and colors on paper; by Tao-chi; poem by the artist and one inscription on painting. 0.250 x 1.578.
- 57.14. Chinese, Yüan dynasty (1260-1368). Scroll in ink and colors on paper showing Yang Kuei-fei mounting a horse; by Ch'ien-hsüan (13th century); inscription and 14 seals on painting. 0.295 x 1.170.
- 56.12. Indian, Mughal, first half of the 17th century. Leaf from the "Jahāngir Album"; recto: landscape with elephant, mahout, and servant; verso: a quatrain in *nasta'liq* on illuminated ground. Overall: 0.425 x 0.265. (Illustrated.)
- 56.8- Japanese, Ashikaga period (1333-1568). Set of three landscapes in ink
- 56.10. on paper; each bears a seal purporting to be that of Kano Motonobu (1476-1559). Each 0.992 x 0.494.
- 56.17- Japanese, Momoyama period (1568-1615). Pair of six-fold screens painted
- 56.18. in ink and color on paper; landscape with birds and flowers; attributed to Kano Sanraku. 1.645 x 3.733.
- 56.20- Japanese, Edo period (1615-1868). Pair of six-fold screens painted in
- 56.21. color on paper with gold ground; two groups of walking cranes; by Kōrin (1658-1716). 1.660 x 3.710.
- 57.2. Japanese, Edo period, Ukiyoe school. Woman and child walking in the rain; ink and color on silk; by Kubo Shunman (1757-1820); signature, poem, and seal on painting. 0.842 x 0.280.
- 57.5. Japanese, Edo period, Ukiyoe school. Two courtesans under a tree; ink and color on silk; by Eishi (1756-1829); signature and one seal. 0.983 x 0.375.
- 57.6. Japanese, Edo period, Ukiyoe school. Two courtesans and a willow tree; in full color on silk; by Eishi (1756-1829); signature and one seal. 0.984 x 0.378.
- 57.7. Japanese, Edo period, Ukiyoe school. Three courtesans under a cherry tree; ink and color on silk; by Eishi (1756-1829); signature and one seal. 0.983 x 0.377.
- 57.9. Japanese, Fujiwara period (897-1185). Image of Fudō-son in ink and slight color on silk; attributed to Ichigyo. 1.675 x 1.175.
- 57.11. Japanese, Ashikaga period (1392-1568). Album of 8 paintings in ink on paper and 8 pages of calligraphy; by Sōami (d. 1525); 16 seals. Average page: 0.280 x 0.514-40.

POTTERY

- 56.23. Chinese, Sung dynasty (960-1279). Shallow dish of *Tz'u-chou* type; buff stoneware covered with white slip; decorated with green and red enamels over the glaze. 0.032 x 0.130.
- 56.24. Chinese, Sung dynasty (960-1279). Tea bowl of *Ohien* type; coarse buff stoneware with thick blackish-brown glaze. 0.055 x 0.110.
- 56.25. Chinese, Ming dynasty, Hsüan-te period (1426-1435). Bottle-shaped vase of gray stoneware covered with thick, even, sea-green celadon glaze; six-character mark of the period incised under glaze on base. 0.257 x 0.139.
- 56.30. Chinese, Six Dynasties (265-589). Ewer of coarse gray stoneware covered with thick, oily, blackish-brown glaze; *Yüeh* ware of *Te-ch'ing* type. 0.235 x 0.116.
- 56.32. Chinese, Ming dynasty (1368-1644). Plain white porcelain vase in form of a faceted cube with cylindrical neck, two loop handles, high flaring base; four characters *ssü-nien-shih-yang* in underglaze blue under base; early 15th century. 0.240 x 0.131.
- 56.13. Japanese, 17th century, Kakiemon ware. Large white porcelain jar decorated in colored enamels over the glaze. 0.404 x 0.310. (Illustrated.)
- 57.1. Japanese, 18th century, Imari ware. Large white porcelain dish decorated in underglaze blue and enamel colors and gold. 0.555 x 0.077.
- 57.10. Japanese, 18th century, Kutani ware. White porcelain octagonal dish on high round foot; decorated in underglaze blue and enamel colors; character *fuku* in underglaze blue under base. 0.087 x 0.228.

REPAIRS TO THE COLLECTIONS

Thirty-two Chinese and Japanese objects were restored, repaired, or remounted by T. Sugiura. In addition to this work on the collections, Mr. Sugiura completed *t'ao* for 26 Chinese books. Assisted by his son Atsushi, he also mounted a large wall map, which was hung in the office. One Chinese painting was repaired for Dumbarton Oaks Library and Collections, and one page of calligraphy was mounted for the United States Department of State.

CHANGES IN EXHIBITIONS

Changes in exhibitions amounted to 1,603. This unusually large number is accounted for by the air-conditioning of the building, re-decoration of exhibition galleries, and reinstallation of exhibitions. The changes were as follows:

| | |
|---------------------------|-----|
| American art: | |
| Oil paintings..... | 132 |
| Pastels and drawings..... | 34 |
| Watercolors..... | 32 |
| Chinese art: | |
| Bronze..... | 179 |
| Gold..... | 11 |
| Jade..... | 177 |
| Manuscripts..... | 2 |

| | |
|-----------------------|-----|
| Chinese art—Continued | |
| Marble..... | 3 |
| Metalwork..... | 26 |
| Paintings..... | 135 |
| Pottery..... | 292 |
| Stone sculpture..... | 26 |
| Christian art: | |
| Crystal..... | 2 |
| Glass..... | 4 |
| Gold..... | 18 |
| Manuscripts..... | 18 |
| Paintings..... | 8 |
| Stone sculpture..... | 2 |
| Indian art: | |
| Bronze..... | 2 |
| Manuscripts..... | 12 |
| Paintings..... | 26 |
| Stone sculpture..... | 8 |
| Japanese art: | |
| Bronze..... | 2 |
| Lacquer..... | 34 |
| Paintings..... | 130 |
| Pottery..... | 44 |
| Wood sculpture..... | 6 |
| Korean art: | |
| Bronze..... | 2 |
| Pottery..... | 36 |
| Near Eastern art: | |
| Bookbindings..... | 10 |
| Crystal..... | 2 |
| Glass..... | 8 |
| Manuscripts..... | 16 |
| Metalwork..... | 36 |
| Paintings..... | 86 |
| Pottery..... | 36 |
| Stone sculpture..... | 2 |
| Tibetan art: | |
| Paintings..... | 4 |

LIBRARY

The specialized museum library must combine many services. It must be a research unit for the staff and graduate students for documenting the gallery's objects and its possible acquisitions; it must serve the high-school, college, and university students, and all those studying the Oriental arts.

The reference service of the library is the most difficult to measure statistically. Each request answered requires immeasurable time, ingenuity, and imagination. The number of scholars from all parts of the world who used the library nearly doubled in number during the year. One visiting scholar, Miss Wellesz, was very grateful when the librarian was able to give her the name of the library in Washington

that had the rare book she had been searching for in Berlin, the British Museum, and the Library of Congress.

With the decataloging of material not in the Freer library subject field it is planned that the future acquisitions adhere to the policy of the library—to supplement the objects of art in the collections. Limited stack space is another governing control.

The most important acquisitions to the library in the past year were 784 books, pamphlets, and periodicals. Of these, 452 were welcome gifts from individuals and exchanges from other institutions. Outstanding among the purchases were *Art and art industry in Siam*, published in two elephant-sized folios, which describe and illustrate the technique of Siamese black-and-gold lacquer work; *Materiaux pour un corpus inscriptionum arabicarum*, issued in three parts in seven tomes of sixteen fascicles and as a part of the *Mémoires* published by the members of the Mission Archéologique Française au Caire; and the first three volumes of Dr. Sirén's work on *Chinese painting, leading masters and principles*. James Michener presented the library with the large folio of *Ukiyoe hanga senshu* (Selected masterpieces of Ukiyoe prints). Microfilms were purchased of the out-of-print books to round out some of the reference materials.

Many bibliographies were compiled; some for publication, a few for replies to letters, and many others for the objects of art in the collections.

PUBLICATIONS

There were no publications issued during the year. *Ars Orientalis* II was in press at the close of the year.

REPRODUCTIONS

The photographic laboratory made 2,510 items during the year as follows: 1,924 prints, 291 negatives, 1,255 color transparencies, and 40 black-and-white slides. Total negatives on hand, 11,308; lantern slides, 10,000; 121 reproductions in the round of Freer Gallery objects were sold.

BUILDING

The general condition of the building is good. Minor repairs were made when necessary throughout the year, and broken and damaged skylights were replaced and waterproofed. Paint was removed from the flagpole and two new coats applied.

Installation of air-conditioning equipment in the building, begun on August 6, 1956, was continued. A cooling tower was installed on the north side of the roof to work in conjunction with the air-conditioning equipment in the subbasement, and other major changes throughout the entire building were made.



56.26

Recent addition to the collections of the Freer Gallery of Art.



56.12



56.13

Recent additions to the collections of the Freer Gallery of Art.

Sections of the terrazzo floors in Galleries 13 and 17 were laid or reground and polished. A vinyl tile floor was installed in the technical laboratory.

The work of making exhibition cases for the galleries continued in the cabinet shop, and miscellaneous odd jobs related to storage, exhibition, restoration, crating, and maintenance of office and Gallery equipment were carried on as usual. Much time was given to various jobs arising as air conditioning of the building progressed, such as dustproofing all grills throughout the entire gallery floor, offices, and storage rooms.

In the court all plantings appear to be doing well. A few replacements were made in the azalea bed, and one American boxwood and one *Ligustrum* were set out to fill in the southeast corner of the court. The fountain was drained, cleaned, repointed, and waterproofed, and drainage around the fountain was corrected. To provide adequate watering, four 20-foot sprinklers were installed in the four corners of the court.

ATTENDANCE

The Gallery was open to the public from 9 to 4:30 every day except Christmas Day. The total number of visitors to come in the main entrance was 112,443. The highest monthly attendance was in April, 14,452, and the lowest was in January, 4,124.

Even while undergoing a major building change of air-conditioning, the office handled 1,948 visitors for the following purposes:

| | |
|--|-----|
| General information..... | 861 |
| To submit objects for examination..... | 370 |
| To see staff members..... | 173 |
| To take photographs in court or exhibition galleries..... | 121 |
| To study in library..... | 252 |
| To see building and installations..... | 25 |
| To examine or borrow slides..... | 12 |
| To sketch in galleries..... | 21 |
| To use Herzfeld Archive..... | 1 |
| To see objects in storage: | |
| American art..... | 19 |
| Armenian, Byzantine, Greek MSS., etc..... | 3 |
| Christian art (Washington MSS.)..... | 18 |
| Far Eastern jade, lacquer, wood, ivory, textiles, etc..... | 11 |
| Far Eastern metalwork..... | 12 |
| Far Eastern paintings..... | 83 |
| Far Eastern pottery..... | 48 |
| Near Eastern glass, bookbindings, etc..... | 13 |
| Near Eastern metalwork..... | 8 |
| Near Eastern paintings..... | 21 |
| Near Eastern pottery..... | 9 |

AUDITORIUM

The series of illustrated lectures was continued as follows:

1956

- October 16. Dr. Richard Edwards, Washington University (St. Louis). "Unique Aspects of Chinese Painting." Attendance, 119.
 November 13. George N. Kates, "The Imperial Lakes of the Forbidden City, Peking." Attendance, 208.

1957

- January 15. Dr. Carl H. Kraeling, Oriental Institute, University of Chicago. "Recent Explorations in Libya." Attendance, 63.
 February 12. James F. Cahill, Freer Fellow. "Painting—Albums in China and Japan." Attendance, 119.
 March 19. E. Arthur Lane, Keeper of Department of Ceramics, Victoria and Albert Museum, London. "Islamic Pottery, XIV-XVIII Centuries." Attendance, 116.
 April 16. Dr. Alexander Soper, Bryn Mawr College. "The Southern Contribution to Early Buddhist Art in China." Attendance, 71.

Three outside organizations used the auditorium, as follows:

1956

- November 27, 28. The United States Department of Agriculture held meetings for field staff members of the Federal Extension Service. Attendance, 78 and 95, respectively.

1957

- February 5. Under the auspices of the Turkish Embassy, Prof. Nureddin Sevin, Ankara State Conservatory, Ankara, Turkey, lectured on "Turkish Art Through the Centuries." (Illustrated.) Attendance, 163.
 February 25. The Agriculture Extension Wives Group held a conference. Attendance, 14.

Four other meetings were held in the building by the Board of Governors, Washington Society, Archaeological Institute of America, Rutherford J. Gettens, president, as follows:

| | |
|------------------------|----------------|
| July 11, 1956..... | Attendance, 8 |
| October 1, 1956..... | Attendance, 9 |
| February 28, 1957..... | Attendance, 8 |
| May 20, 1957..... | Attendance, 10 |

STAFF ACTIVITIES

The work of the staff members has been devoted to the study of new accessions, of objects contemplated for purchase, and of objects submitted for examination, as well as to individual research projects in the fields represented by the collections of Chinese, Japanese, Persian, Arabic, and Indian materials. Reports, oral or written, and exclusive of those made by the technical laboratory (listed below) were made on 3,660 objects as follows: For private individuals, 1,603; for

dealers, 787; for other museums, 1,270. In all, 1,850 photographs were examined, and 563 Oriental language inscriptions were translated for outside individuals and institutions. By request, 16 groups totaling 314 persons met in the exhibition galleries for docent service by staff members. Two groups totaling 25 persons were given docent service in the storage rooms by staff members.

Among the visitors were 57 distinguished foreign scholars or persons holding official positions in their own countries who came here under the auspices of the State Department to study museum administration and practices in this country.

In the technical laboratory 51 objects from the Freer collections and 46 from outside sources were examined. The following project was begun:

1. Collection of specimens and information on various efflorescences on objects in museum cases.

The following projects were continued:

1. X-ray diffraction studies on jade objects in the Freer collections.
2. Collection of further specimens and information about the occurrence and distribution of smalt (cobalt blue glass pigment) in the Near and Far East.
3. Collection of further specimens and information about Maya blue pigment from Central American sources.
4. Collection of further specimens and information on the red pigment vermilion on ancient Chinese objects.
5. Examination of specimens of wall paintings from the ancient Christian church of the Chora in Istanbul in cooperation with Dumbarton Oaks Research Library and Collection.

The following projects were completed:

1. Development of technique of mounting paint cross sections in cold-setting polyester resin for microscopic identification.
2. Preparation of a selected bibliography on the conservation of ancient bronzes.
3. Conservation and treatment of several Freer objects, including bronzes, pottery, stone reliefs, and wooden sculptures.
4. Collection of about 400 quantitative chemical analyses of ancient bronzes reported in the literature.

During the year, 7 written reports were made and 37 verbal reports given on objects examined in the technical laboratory.

In August, Dr. Pope began a 7-month trip to the Far East and Southeast Asia to study museums, private collections, and kilnsites in connection with his research in various phases of Far Eastern ceramics. After brief visits to the museums in Seattle and Honolulu, he spent 2 months in Japan, 2 weeks in Formosa, 10 days in Hong Kong, 5 days in Saigon, 3 days in Phnom Penh, 6 days at Angkor, and a week in Singapore. Then followed 17 days in Java, 2 weeks in Sarawak, a month in Thailand, 3 days in Rangoon, a week in Calcutta, and 2 weeks

in London to see further collections and consult with colleagues en route home.

By invitation the following lectures (illustrated unless otherwise noted) were given outside the Gallery by staff members:

1956

- July 9. Dr. Ettinghausen, at the opening of an exhibition of Islamic art sponsored by the Summer Institute of Middle Eastern Studies of Ohio State University at the Ohio State Historical Museum, on "Islamic Art." Attendance, 175.
- September 24. Dr. Pope, at the American Embassy, Tokyo, Japan, on "Chinese Ceramics in the Freer Gallery of Art." Attendance, 40.
- October 16. Dr. Pope, at Jimbun Kagaku Kenkyusho (Institute for Humanistic Studies), Kyoto, Japan, on "Chinese Porcelains from the Ardebil Shrine." Attendance, 100.
- November 9. Dr. Ettinghausen, in Baltimore, to the Women's Committee, Baltimore Museum of Art, on "Persian Miniature Painting." Attendance, 196.
- November 14. Mr. Gettens, in Bethesda, Md., at the Abracadabra Club, on "The Van Meegeran Art Forgery Case and Trial." (Illustrated with his own photographs.) Attendance, 25.

1957

- January 7. Mr. Stern, at the University of Maryland, on "Japanese Wood-block Prints" at the opening of an exhibition of Ukiyoe wood-block printing. Attendance, 50.
- February 12. Mr. Gettens, at the Broadmoor Hotel, Washington, D. C., to the American Ceramic Society, Baltimore-Washington Section, on "The Early Use of Cobalt Minerals in the Coloring of Smalt, Glass and Pottery Glaze." Attendance, 30.
- February 13. Mr. Stern, at the opening of the exhibition of the Hauge Collection, American University, Washington, D. C., on "Japanese Art." Attendance, 60. This was recorded for future broadcasts by the Voice of America, television and radio.
- February 14. Mr. Gettens, at the Presbyterian Church, Falls Church, Va., to the Women's Group, on "Some Personal Experiences with the Dead Sea Scrolls." Attendance, 140.
- February 25. Dr. Pope, at the Siam Society, Bangkok, on "The Smithsonian Institution and the Freer Gallery of Art." Attendance, 50.
- March 20. Dr. Pope, at the Oriental Ceramic Society, London, on "Things of Interest Seen on My Trip." Attendance, 125.
- April 29. Dr. Pope, at the Cosmos Club, Washington, D. C., on "Art in the Orient." Attendance, 275.
- June 22. Mr. Gettens, at the Presbyterian Church, Mooers, N. Y., Sesquicentennial Celebration, on "Some Personal Experiences with the Dead Sea Scrolls." Attendance, 125.

Members of the staff traveled outside Washington on official business as follows:

1956

- July 17-20. Mr. Gettens, in Cambridge, Mass., Fogg Art Museum, consulted the Conservation, Oriental, and Photography Departments about old records and photographs on smalt. Sampled three Fogg objects in connection with this technical problem.
- July 21-22. Dr. Ettinghausen, in Cincinnati, Ohio, the Cincinnati Museum of Art, to study Near Eastern and Indian collections.
- August 2-6. Dr. Ettinghausen, in Ann Arbor, at the University of Michigan, discussed *Ars Orientalis* III. Also visited the Kelsey Museum of Archaeology to see a Coptic exhibition.
- August 7. Dr. Ettinghausen, in Detroit, to see the Near Eastern collection at the Detroit Institute of Arts.
- August 11. Dr. Ettinghausen, in Corning, N. Y., examined objects at the Corning Museum of Glass and discussed research problems with their staff.
- August 24. Dr. Ettinghausen, in Cambridge, Fogg Art Museum, saw an exhibition of Islamic art and studied their photographic collection. Examined objects at the Center of Middle Eastern Studies and in two private collections.
- August 28. Dr. Ettinghausen, in Cambridge, examined Russian publications on Near Eastern archeology in the Semitic Museum, Harvard University. In Boston, examined objects at the Isabella Stewart Gardner Museum and the Museum of Fine Arts.
- September 4. Mr. Stern, in New York, examined objects at dealers.
- September 5. Miss Elisabeth West, in Toronto, Canada, at the Royal Ontario Museum of Archaeology, visited their laboratory where she examined objects and obtained samples of early Chinese blue glass for the Freer Gallery technical laboratory.
- September 6-7. Mr. Gettens, in Corning, N. Y., examined objects at the Corning Museum of Glass and watched the processing and etching of glass.
- September 20. Mr. Gettens, in Atlantic City, N. J., read a paper entitled "On the Origin of Smalt and the Early Use of Cobalt in Blue Glass and Pottery Glazes" at a symposium held by the American Chemical Society on "Ancient Chemistry." Attendance, 30.
- October 5. Mr. Wenley and Mr. Stern, in Philadelphia, attended the opening of the exhibition of the Caspary Collection at the Philadelphia Museum of Art.
- October 9. Dr. Ettinghausen, in Baltimore, examined objects at the Walters Art Gallery and the Baltimore Museum of Art.
- October 28-30. Mr. Wenley, in Ann Arbor, attended a meeting of the Freer Fund Committee and conferred with staff members about *Ars Orientalis*.

1956

- November 9-10. Mr. Stern, in New York, examined objects at the Willard Gallery and the Oriental Art Gallery.
- November 23-26. Mr. Gettens, in New York, examined objects at dealers and in one private collection. Conferred with the Director of the Metropolitan Museum of Art about a Rembrandt painting.
- November 30. Mr. Gettens and Miss Elisabeth West, in Baltimore, examined paintings in the Walters Art Gallery and obtained paint samples from Flemish and Florentine paintings.
- December 3-7. Dr. Ettinghausen, in New York, examined objects belonging to dealers.
- December 28-29. Mr. Gettens, in Philadelphia, attended the annual meeting of the Archaeological Institute of America; examined objects in the Pennsylvania Academy of Fine Arts and the University of Pennsylvania Museum, and also observed the restoration work in progress in Independence Hall.

1957

- January 10-13. Mr. Stern, in New York, examined objects at dealers and in the Metropolitan Museum of Art.
- January 24. Dr. Ettinghausen, in New York, examined objects at dealers and in one private collection.
- February 1. Dr. Ettinghausen, in Baltimore, examined objects at the Baltimore Museum of Art.
- February 2. Dr. Ettinghausen, in Baltimore, examined objects at the Walters Art Gallery.
- March 8-9. Dr. Ettinghausen, in Chicago, attended a conference on the composition of a manual for the teaching of Islamic civilization sponsored by the University of Chicago and the Rockefeller Foundation. Examined photographs at the Oriental Institute.
- March 11. Dr. Ettinghausen, in Minneapolis, examined objects at the Minneapolis Institute of Art.
- March 12. Dr. Ettinghausen, in Chicago, examined objects at the Art Institute of Chicago.
- March 11-13. Mr. Gettens, in Chicago, attended a Conference on Archaeological Identification and the Cooperation of Specialists in Related Disciplines at the Oriental Institute, University of Chicago, under the auspices of the National Research Foundation. He read a paper entitled "Problems in Archaeological Identifications: the Identification of Materials of Cultural Remains." Attendance, 40.
- April 2-5. Mr. Gettens, in Oberlin, Ohio, attended a seminar on "Resinous Surface Coatings" at Oberlin College under the auspices of the Intermuseum Conservation Association. He read a paper entitled "Summary of the History of Resinous Surface Coatings." Attendance, 50.
- April 2-6. Mr. Wenley, in Boston, attended the sessions of the Ninth Annual Meeting of the Association for Asian Studies (formerly the Far Eastern Association, Inc.), the Far Eastern Ceramic Group, and the Far Eastern Ceramic Group Council.
- April 11-12. Mr. Wenley, in Ann Arbor, attended a meeting of the Freer Fund Committee at the University of Michigan.

1957

- April 23-25. Mr. Wenley, in Princeton, N. J., attended sessions of the American Oriental Society, and in the absence of Dr. Schuyler Cammann, presided as chairman at the meeting of the Far Eastern Section.
- April 26. Mr. Wenley and Dr. Ettinghausen, in New York, examined objects at dealers. Attended the dinner and formal opening of the Kevorkian Gallery of Ancient Near Eastern Art at the Brooklyn Museum of Art.
- April 27. Mr. Wenley and Dr. Ettinghausen, in New York, examined objects at dealers.
- May 21. Mrs. Lnor O. West, in Chicago, attended the Museum Store Association meeting at the Art Institute of Chicago.
- May 25-26. Mr. Wenley, in St. Louis, Mo., attended the Association of Art Museum Directors meetings at the City Art Museum.
- June 3-5. Mr. Gettens, in Winterthur, Del., attended the symposium on Museum Operation and Connoisseurship and participated in the round-table discussion on "Case Study, Identifying and Interpreting an Object" at the Henry Francis du Pont Winterthur Museum.
- June 24-26. Mrs. Bertha M. Usilton, at Kansas City, Mo., attended the annual meeting and Art Reference Round Table of the American Library Association.
- June 25-28. Mr. Gettens, in Boston, examined objects at the Fogg Art Museum in connection with his technical projects.

Members of the staff held honorary posts, received recognition, and undertook additional duties outside the Gallery as follows:

- Mr. Wenley :** Research Professor of Oriental Art, Department of Fine Arts, University of Michigan.
Member, Visiting Committee, Board of Overseers of Dumbarton Oaks Research Library and Collection.
Member, Smithsonian Art Commission.
Member, Advisory Committee on Exchange in the Arts, Department of State, United States Advisory Commission on Educational Exchanges.
Member, Smithsonian Institution Sub-Committee on Research Programs.
Chairman, Louise Wallace Hackney Scholarship Committee of the American Oriental Society.
Vice President, Textile Museum, Washington, D. C.
Vice President, Cosmos Club, Washington, D. C.
- Dr. Pope :** Member, Visiting Committee, Board of Overseers of Harvard College to the Department of Far Eastern Civilizations.
Member, Editorial Board, *Archives* of the Chinese Art Society of America.
President, Far Eastern Ceramic Group.
Made three tape recordings for Radio Sarawak, Kuching:
(1) An interview with Tom Harrisson, Curator, Sarawak Museum, about Dr. Pope's interest in the ancient Chinese porcelain trade; (2) an interview by Mr. Harrisson on Dr. Pope's impressions of the excavations made by Mr. Harrisson in the Santubong delta; (3) a talk on Charles Lang Freer and the Freer Gallery of Art.

- Dr. Pope:** While going through the Freer exhibition galleries, made a tape recording in French in reply to questions by Mme. Fevrier for Voice of America broadcasts.
- Dr. Ettinghausen:** Organized an exhibition of Islamic art at the Ohio State Historical Museum, Columbus, Ohio, for the Summer Program on the Middle East at Ohio State University. Discussed the Freer Gallery of Art and its collections in Persian with Mahmoud Danishvar of Tehran. This was tape recorded for use on Voice of America broadcasts. Translated into Persian his "Foreword, An Exhibition of Illustrations to Fifty Quatrains by Omar Khayyam by the Contemporary Iranian Painter, Hossein Behzad" to be used on Voice of America broadcasts in Iran by Morteza K. Yahyavi. Made a tape recording in German for Voice of America broadcasts in Vienna, Austria, on "The Freer Gallery of Art and Its Collections." The interviewer was Oliver Bryk.
- Mr. Gettens:** Chairman, Art Committee, Cosmos Club. Member, Ad Hoc Committee on Restoration of Catlin Paintings, Smithsonian Institution. President, Washington Society, Archaeological Institute of America.
- Mrs. Usilton:** Member, Council of the District of Columbia, Library Association, as Publicity Chairman. Advisor and critic of the schedules for 700's (Fine Arts) of the Dewey Decimal Classification, 16th edition.

Respectfully submitted.

A. G. WENLEY, *Director.*

DR. LEONARD CARMICHAEL,
Secretary, Smithsonian Institution.

Report on the National Air Museum

SIR: I have the honor to submit the following report on the activities of the National Air Museum for the fiscal year ended June 30, 1957:

The occurrence of greatest importance to the National Air Museum during the fiscal year 1957 was the introduction in Congress of a bill proposing the reservation of a definite site on the Mall, in Washington, for the National Air Museum building. Introduced in the Senate on May 2, 1957, by the Honorable Clinton P. Anderson, this bill, S. 1985, would reserve for this Museum an area directly across the Mall from the National Gallery of Art. The site is bounded on the north by Jefferson Drive, on the east by Fourth Street, on the south by Independence Avenue, and on the west by Seventh Street, and would provide space for a building with a base of approximately 300,000 square feet. It has been approved for the Museum by the National Capital Planning Commission.

Great progress was made in establishing a shop for the restoration of aircraft that have long been in storage. The exhibition area remains the same as in former years, but rearrangements were made to give more space to individual exhibits. Important accessions were received. The number of sources from which specimens were obtained compares favorably with other years, while the number of specimens acquired is greater than in any previous year owing to an important transfer of aeronautical instruments and similar material from the National Bureau of Standards.

The fame of the National Air Museum as a depository for evidence of aeronautical history and progress is constantly increasing. More and more time is required from the staff to furnish information to visitors and correspondents. Many demands for facts are received by phone from Government agencies. It is increasingly apparent that the aircraft industry and persons engaged in aeronautical research depend on the Museum for this service. Accurate replies should be given promptly, but the present curatorial staff can no longer keep abreast of the increased demand. Two additional curatorial positions have been authorized, and it is hoped that qualified persons can be obtained to fill them.

ADVISORY BOARD

Two meetings of the Advisory Board of the National Air Museum were held, at which progress was reported and plans discussed.

Two changes occurred in the membership of the Board. Maj. Gen. John P. Doyle, who retired from the Air Force, was succeeded by Maj. Gen. Reuben C. Hood, Jr., as representative of the Chief of Staff of the Air Force. The vacancy created by the death in 1956 of William B. Stout was filled by the Presidential appointment of Lt. Gen. James H. Doolittle. The other members of the Board, Dr. Leonard Carmichael, chairman; Rear Adm. James S. Russell, representing the Chief of Naval Operations; and Grover Loening, Presidential appointee, continued their service on this Board.

At the meeting of the Board on December 14, 1956, all members were present. The chairman summarized the history of the National Air Museum; described progress in the care of stored aircraft; and again acknowledged the generous gift from the Aircraft Industries Association and the Air Transport Association of \$25,000, used for an architectural study of a National Air Museum building. Mr. Loening advocated the division of the Museum into two parts: a monumental exhibition building for outstanding specimens, and a secondary facility in suburban Washington for the study collections. Dr. Carmichael outlined the difficulties encountered during efforts to obtain a preferred site for the exhibition building. Because of prospects of expansion, the appointment of a director for the Museum was urged. Cooperation with the new Air Force Central Museum recently established at Wright-Patterson Air Force Base in Ohio was discussed. A letter affirming Air Force policy was presented by General Hood, in which it was stated that aeronautical specimens held by the Air Force that were primarily of national importance would be transferred to the National Air Museum whenever space becomes available for their display. A progress report was presented on the sculpturing and casting of the William Mitchell statue. The Board resolved that it be accepted and an appropriate ceremony be scheduled for its presentation. Following a discussion of several aircraft believed to be available to the Museum, and a statement by Admiral Russell regarding the problems experienced by the Navy in recording and storing specimens being preserved for the Museum, the meeting adjourned.

The next meeting of the Advisory Board was held on May 24, 1957, following the news of the bill introduced in Congress to reserve a site on the Mall for the National Air Museum. All members attended the meeting and enthusiastically discussed the advantages of this site and plans for the building. It was pointed out that details of building construction and exhibition arrangements studied during the planning of buildings for other proposed sites could be utilized in determining the form of structure and interior arrangements for this latest project. It was agreed that the next step would be to obtain authorization by the Congress for the construction of the building and funds for the preparation of plans.

A written report of curatorial activities since the previous meeting was submitted; the need for additional staff, including a director, was considered; and activities of other aeronautical museums were discussed in terms of relation to and cooperation by and with the National Air Museum. Particular attention was given to progress with the William Mitchell statue project.

STEPHENSON BEQUEST

Previous annual reports have included details regarding the authorization by Congress for the Secretary of the Smithsonian Institution to accept as a gift from the late George H. Stephenson of Philadelphia a statue of Brig. Gen. William Mitchell. The sculpturing by Bruce Moore progressed during the year to the completion of the full-sized plaster cast and its delivery to the foundry for casting in bronze. The granite base is being cut. The full-length figure, in World War I uniform, mounted on its base will be about 10 feet in height and, pending completion of the Aeronautical Hall of Fame in the proposed new building, will be placed in the Arts and Industries Building adjacent to Air Force displays. The formal presentation ceremony is scheduled for December 17, 1957, as a climactic feature of the year that celebrates the 50th Anniversary of the United States Air Force.

SPECIAL EVENTS AND DISPLAYS

The year 1956 was celebrated in Denmark as the 50th anniversary of the first flight there by James Christian Ellehammer, which occurred September 12, 1906. A reproduction of his airplane of 1906 was constructed in Denmark, and a copy of his 1909 airplane was flown there. Another feature of the anniversary year occurred on December 11, 1956, when a model of the 1906 aircraft was presented to the Secretary of the Smithsonian Institution for the National Air Museum by His Excellency, the Ambassador of Denmark, Henrik Kauffmann, in the Regents' room of the Smithsonian Building, and in the presence of a distinguished group of officials, aeronautical historians, and Smithsonian personnel. The model is constructed to a scale of 1:14 and reflects Ellehammer's earlier interest in kites in the diamond shape of its principal surface. A miniature reproduction of the engine that Ellehammer made is mounted at the front, and the 3-wheeled chassis and tethering connection illustrates how the aircraft was guided over its circular path and rose for a flight of about 140 feet at a height of about 18 inches, with Ellehammer on a bicycle seat just behind the engine.

For the annual meeting of the Regents of the Smithsonian Institution on January 18, 1957, the National Air Museum displayed a series of scale models illustrating development of United States naval air-

planes. This display was particularly timely because the Vought F8U-1 "Crusader" Navy fighter plane had recently established a new national speed record of 1,015.4 miles an hour. Contrasted with a model of that jet-powered swept-winged fighter was a similarly scaled 1:16-size reproduction of the Navy's first seaplane of 1911, which flew at about 50 miles an hour, and of models of Navy planes used in World Wars I and II.

The National Air Museum was represented by the head curator at the National Air Races held at Oklahoma City on Labor Day; at the directors meeting of the National Aeronautic Association, held in Washington on October 2, on the Brewer Trophy Committee to choose the person most prominent in 1956 in the field of aviation education for youth; at the Wright Brothers Banquet of the Aero Club of Washington, on the 53d anniversary of the first flight, December 17, 1956; and at the American Helicopter Society Forum held in Washington on May 10, 1957. At the model airplane exhibition held at Cleveland on February 22, the head curator served as chief judge, selecting three outstanding models for the Museum collections. For the First National Conference on Aviation Education, organized by the National Aviation Education Council and held in Washington March 7-8, 1957, the National Air Museum was represented by both the head curator and the associate curator, the former as speaker on "Aviation as a Vocation and Avocation" and the latter as consultant on Aviation Curriculum Enrichment. Among the 23 lectures given on various aspects of flight during the year by the head curator, two were presented to aeronautical groups at universities, three to units of the Institute of Aeronautical Sciences, and three to military units. Six lecture tours of the aeronautical exhibits were given, five to military units, and the other to a group of progressive youths sponsored by Representative Peter Mack of Illinois.

The Museum participated in three television programs on aeronautical history during the year; the head curator spoke on three radio programs and made sound tapes for two others, all relative to the functions and exhibits of this Museum. Numerous persons preparing broadcast programs consulted the Museum for facts.

IMPROVEMENTS IN EXHIBITS

Many of the displays maintained in the Aircraft Building and in the Aeronautical Hall of the Arts and Industries Building were improved during the year. Several specimens were added to the Robert J. Collier Trophy display illustrating annual awards "for the greatest achievement in aviation in America, the value of which has been thoroughly demonstrated by actual use during the preceding year." The display of the Klemin Plaque awarded annually by the American

Helicopter Society to outstanding personages in that field; the case containing mementos of Wiley Post and his two world flights; the Postal Aviation exhibit featuring models of historic airmail planes; the Amelia Earhart Memorial Collection; and the aeronautical instrument collection were improved. A series of paintings of jet-powered aircraft by the noted artist Charles Hubbell was added to the exhibition of the Whittle jet engine. The case containing noted aeronautical awards, including the Curtiss Marine, Pulitzer, Harmon, Brewer, and Wright brothers trophies, was rearranged and labels were rewritten. The case containing model aircraft of the first World War and the commercial models exhibit were rearranged, and the impressive series of models illustrating types developed by the Wright brothers and their company was improved by the addition of several models, prints, and structural specimens. A seasonal exhibit of kites attracted attention from the younger visitors and from aeronautical historians who recognize the kite as the fundamental manmade aircraft. Some of these early types of kites embody the genesis of important aerodynamic features.

The 40-year-old prefabricated steel Aircraft Building, actually a World War I airplane hangar, was provided with a new skirting around its lower edge, extending over the concrete curbing so that rain will drain outward instead of seeping inward. The sloping wall was painted.

The Smithsonian Print Shop prepared a number of labels to replace the former temporary ones, greatly improving appearance and legibility. All the suspended airplanes in the Arts and Industries Building were cleaned, and several fabric repairs were made. The Wright Military and Curtiss Pusher airplanes were provided with glass screens at their wing tips to protect them from handling by visitors. The Langley quarter-size model aerodrome was re-covered; the large display case containing airplane models of the pre-World War I period was disassembled, moved from the Arts and Industries Building and re-erected in the Aircraft Building, and the models reinstalled; and exhibits of relics associated with the first transcontinental flight and the First Aero Squadron of World War I were improved.

The Air Force Central Museum at Wright-Patterson Field transferred to this Museum a 3-unit wall case in which scale models showing the progress in design of Air Force planes have been installed. This new case is provided with shielded lighting and illuminated label frames and is a great improvement over the floor case formerly used.

Many of the new accessions listed at the end of this report were prepared for exhibition during this year; others must be held in storage until the new building is completed.

RESTORATION OF STORED AIRCRAFT

At the end of the previous fiscal year all the buildings at the National Air Museum Restoration Facility in the Suitland, Md., building area had been erected; a force consisting of a foreman, two aircraft mechanics, a vehicular mechanic, and an aide had been engaged, and they were setting up a shop in the largest building. In that shop the stored aircraft, principally those World War II planes that had been transferred from the Air Force by order of Gen. H. H. Arnold, will be prepared for eventual exhibition and study.

That large building, known as No. 10, and measuring 200 by 180 feet, was improved by the addition of a concrete ramp in front; installation of gas heat in one of its 60-foot-wide sections, involving the erection of a 200-foot partition to confine the heat to that area; and insulation of the ceiling and walls. Electric service was increased and extended to the newly installed power tools and equipment, including a metal-cutting band saw, punch press, belt and disk sanders, air compressor, plastic-heating oven, drill press, and other devices for the fabrication and repair of aircraft parts. This shop area is becoming a well-organized and efficient unit of the Museum. Using scrap material for the most part, the facility personnel have constructed a tool crib, sheet-metal rack, scrap boxes, parts bins, welding area, and benches for special tools.

Because many of these aircraft were stored at Park Ridge, Ill., for a long time in the open, and then subjected to the hazards of overland shipment, they must be removed from their boxes and cared for as quickly as possible in order to arrest deterioration. During the year seven airplanes and seven rotorcraft were unboxed, inspected, and corrective work started. One aircraft, the World War I De Havilland-4, was completely restored. This entailed splicing the broken longerons; cleaning and repairing the transverse frame of the fuselage; re-covering the control surfaces, with assistance from the fabric shop at Bolling Air Force Base; cleaning and redoping the wings; cleaning the engine; and making numerous repairs to equipment. This airplane is now ready for exhibition. In connection with the work on other aircraft a number of pieces of shop equipment have been made, including fuselage and wing cradles, engine covers, and handling gear. Some special tools had to be fabricated from raw stock.

In response to a request from the Department of Justice all the autogiros in the facility were moved to Building 10, unboxed, and partly assembled for examination in connection with investigation of patent claims against the Government. The information thus obtained was helpful in studying details of the case. The DC-3 transport airplane, given to the Museum in 1953 by Eastern Airlines

and flown into the Washington Airport, was disassembled there by Museum personnel with help of the airline crew and hauled by truck to Suitland, the fuselage being towed on its own wheels. The German V-1 buzz bomb of World War II was assembled and painted, with the assistance of Andrews Air Force Base mechanics. At the close of the year preparations were being made to set up our own paint-spraying booth.

In Building 1 a shop for maintenance of vehicular and handling equipment has been organized. Because much of the equipment for lifting heavy loads was obtained from Government surplus stock, it has required reconditioning. Repairs have been conducted during the year on five forklifts, a crane, truck, and bulldozer, and the associated slings, dollies, jacks, hoists, and other material. Some repairs have been made to the roads connecting the buildings.

The four large aircraft that remain stored in the open at Andrews Air Force Base, and which suffered from vandalism and exposure until Museum personnel could be engaged to care for them, were the first to receive preservative attention from the Museum crew. All openings on these aircraft were sealed; control surfaces, propellers, and tires removed; engines cleaned and sprayed; landing gears shored; and the wings and fuselages securely tied down.

Final projects of the year were the unloading of the Bell VTOL aircraft, and the removal of two airplanes from exhibition for repair.

ASSISTANCE TO GOVERNMENT DEPARTMENTS

During the fiscal year it was acknowledged by the Court of Claims that the Curtiss Army racing airplane of 1925, preserved here since 1927, embodies wing details that enabled the Government successfully to defend itself against a claim involving nearly half a million dollars. That amount alone is several times the annual appropriation for this Museum. In addition, the Justice Department was furnished information and shown material relative to claims pertaining to rotorcraft, airplane control devices, and parachute releases. The fact that this information was readily made available to the investigators saved time and expense to the Justice Department. If the related specimens had not been preserved the Government's cause would certainly have been weakened.

Many offices within the Government requested and received assistance and information from the Museum during the year. Among these were the U. S. Information Agency; the Office of Military History; the Air Force Information Service; the Department of Defense, Office of Public Information, and the same Department's Office of Scientific Information; the Air Force Research Unit; the Air Research and Development Command; the State Department, Office of

Dependent Area Affairs; the Voice of America; and the Government-published magazine *America Illustrated*. Subjects included the history of jet aircraft and guided missiles, identification of persons in photographs, the story of skywriting, flight clothing and uniforms, addresses of companies and persons, the history of transatlantic flying, lives of aeronautical pioneers, data on famous aircraft and some obscure ones, first instances of structural details and accessories in aircraft, air-sea rescue devices, and many others. The Department of the Interior asked about early uses of airplanes in Alaska, the Air Force Museum was supplied with photographs for its displays, the Coast Guard received help with an exhibit on antarctic flying, the National Advisory Committee for Aeronautics was aided in locating data on a helicopter pioneer, and the Geological Survey was interested in maps used by Charles Lindbergh when he flew across the Atlantic in 1927. The Civil Aeronautics Administration was helped with facts about airmail history, in identifying an obsolete "flying wing" aircraft, and pioneer flyers. Speech writers in the Navy Department requested help in assembling facts for talks to be given by their head officers; at the beginning of the Naval project, which culminated in establishing a new altitude record for balloons, the Museum was asked to furnish information about earlier attempts to reach record heights; and the Navy's Hydrographic Laboratory, experimenting with hydrofoils, was informed about earlier experiments with water vanes. Several times during the year the Navy was assisted in preparation of a film illustrating the development of Naval aviation as recalled by the pilots and engineers who helped to make that history. Such assistance with important projects admittedly saved time for the research workers, and prevented duplication of work already accomplished and a search for details proved or rejected. From the offices of a number of Congressmen requests were received for information needed by constituents, and in every case help was given to the extent possible by the limited staff and facilities of the Museum.

PUBLIC INFORMATIONAL SERVICE

As stated in the opening paragraphs of this report, furnishing information to the public is a function most demanding on the time of the staff. This service occupies a large portion of each Museum day, but space permits only a few highlights to be given here.

General Dynamics Corporation's Convair Aircraft, preparing a history of its third of a century in aircraft production, used the National Air Museum's reference files and photographic prints to prepare the background, and Capital Airlines found useful information here for its historic review. Many aeronautical organizations found

Museum records to be helpful: the Aero Club of Washington selected its honor guests for the annual banquet on the basis of accomplishments determined in part from information furnished by the Museum; the Air Force Association used the Museum's files in planning its convention; the OX-5 Club, formed of pilots who flew behind the worthy engine of that name, was aided in preparing its meetings; and the reunion of the World War I 20th Squadron was made more enjoyable because of help from the Museum. The Early Birds, an organization of those who flew solo during the first 13 years of human flight, continue to ask the Museum to help in arranging meetings, recalling historic events, and preserving their treasures associated with early flying.

The city of Philadelphia was assisted in celebrating the 45th anniversary of a "race" between Lincoln Beachey, Hugh Robinson, and Eugene Ely, flying from Governors Island, N. Y., to Philadelphia in Curtiss pusher airplanes. The Art Center at Kalamazoo, Mich., was helped in preparing a display of artistic and aerodynamic kites. Artists were aided in preparing authentic paintings of World War aircraft, airmail planes, and Zeppelins. Many reporters consulted the Museum for details, especially at the time when the Presidential helicopters landed on the White House lawn, and newspapermen wanted to know of previous instances when landings had been made there. The Museum told them about Harry Atwood making a Presidential visit in his Wright-B airplane in 1911 and James Ray piloting an autogiro to land beside President Hoover in 1931.

Among the many publications that checked their articles from Museum facts were the *National Geographic Magazine* inquiring about airplane control, and Air Force history; *Reader's Digest* asking about Sikorsky's helicopters and Lindbergh's flight to Paris; *Life*, needing details on polar flying; the *Saturday Evening Post* to get the story of the first transcontinental flight; Fairchild Aircraft's *Pegasus* to obtain photographs and to learn about the military demonstration flights at Fort Myer, Va., in 1909; *Coronet* asking about the pioneer of rocketry, Robert Goddard; and the World Book Encyclopedia to receive help with biographies of noted flyers.

Many schoolteachers received help in planning their aviation courses, and numerous students appealed to the Museum for answers; the newly established school at Cedar Rapids, named for the Wright brothers, obtained from the Museum a series of photographs of Wright aircraft to decorate its halls; while college students used Museum facts in preparing their theses.

Several of the aviation motion pictures that were shown during the year had utilized Museum records in their preparation, notably, the "Spirit of St. Louis." Aeronautical books reflected the work of their

authors who came to the Museum for assistance. Persons constructing full-sized reproductions of famous aircraft in which to recapture the romance of flying of the early days, and modelmakers enjoying the hobby of building noted aircraft in miniature, wrote or came to the Museum for help.

REFERENCE MATERIAL

The National Air Museum library, reference files, and documents form an indispensable supplement to the knowledge of the staff and are of great value to researchers who come to the Museum. These records are used when labels are written, catalogs compiled, letters answered, and statements require authentication. Realizing that all this constitutes a valuable public service, a number of other aeronautical historians and collectors have deposited their reference material with the Museum, where it continues to be available to themselves and also serves others. The cooperation of the following persons and organizations is sincerely appreciated:

- BERLINER, HENRY A., Washington, D. C. : Two scrapbooks assembled by his father, Emile Berliner, recording experiments by father and son with helicopters, airplanes, and aircraft engines from 1903 to 1925.
- BODINE, JOHN W., West Trenton, N. J. : Selection of aeronautical periodicals to aid in completing Museum volumes.
- BOWEN, TREVOR, Burry Port, Wales : Photographs of the monument commemorating the arrival of Amelia Earhart at the end of her first transatlantic flight in the Fokker *Friendship*, with Wilmer Stutz and Louis Gordon, June 8, 1928.
- CLINE, CAPT. JOSEPH, Coronado, Calif. : Photograph album illustrating activities of the First Aeronautic Detachment, U. S. Navy, in World War I (loan).
- FIFE, RAY, Coronado, Calif. : File of newspaper articles pertaining to the airplane *Spirit of St. Louis* and reference items on Convair aircraft.
- FIRST MARINE AVIATION FORCE VETERANS ASSOCIATION, through J. E. Nicholson, Adjutant, Baltimore, Md. : Photographs of U. S. Marine aircraft and personnel operating in France during World War I (loan).
- FRANKLIN INSTITUTE, Philadelphia, Pa., through Director A. C. Carlton and Capt. Ralph Barnaby, U. S. N. (Ret.) : A scrapbook and a selection of aviation prints collected by the late S. S. Jerwan, pioneer flyer in Moisant airplanes, 1910, and later an instructor in flying.
- GREGG, RICHARD, Kalamazoo, Mich. : Photographs and slides of a special display of kites assembled by him at the Art Center (loan).
- HAMILTON STANDARD, Windsor Locks, Conn. : A motion-picture film, "Keep 'Em Flying," describing the operation and servicing of a hydromatic propeller.
- JABRETT, COL. BURLING, Aberdeen, Md. : A motion-picture film compiled by himself and Maj. Kimbrough Brown, describing the life and flight of the German World War I Ace, Baron Manfred Von Richthofen (loan).
- JONES, MRS. ERNEST L., Clifton, Va. : Original manuscript of the chronology compiled by her late husband, Col. E. L. Jones, comprising a detailed listing of events in aeronautical history. A very valuable reference work.
- KIRK, PRESTON, North Platte, Nebr. : An original booklet describing aircraft engines developed by Charles Lawrance.
- LEVER, HARRY (Estate of), Washington, D. C. : Two aeronautical dictionaries used by him while aviation editor of the *Washington Star*.

- LIBRARY OF CONGRESS**, Washington, D. C.: Charts showing details of aeronautical equipment, drawings of German aircraft, World War I recognition posters of German airplanes, 21 photographs of historic aircraft, and, through Dr. Robert Multhauf, a copy of *Locomotion Aérienne* by D'Amecourt, 1864.
- LINCOLN PRESS**, Washington, D. C.: Copies of Jane's "All the World's Aircraft" (loan); bound volumes of the magazine *Aero Digest*, and a quantity of back issues of this magazine (gift).
- MANDRAKE, CHARLES G.**, and **LONGO, ROBERT**, Wichita, Kans.; Copy of "The Gee Bee Story," a history of Granville brothers' racing planes, 1920-1939.
- NAVY, DEPARTMENT OF THE**, Washington, D. C.: A reprint of the log of the Navy's first airplane, the Curtiss A-1 of 1911; drawings of the N-9 training plane and of the F5L patrol plane of World War I.
- NICEWARNER, MRS. R. J.**, Bethesda, Md.: Album of photographs assembled by her father, Capt. Kenneth Whiting, U. S. N., illustrating his experiences as a pioneer in naval aviation and in the development of the aircraft carrier (loan).
- NIETO, JOSEPH**, San Antonio, Tex.: Drawings of World War I airplanes and of commercial planes of the 1930's (purchased). Motion-picture films of notable flights (gift).
- NIPPON AERO CLUB**, Tokyo, Japan, through S. Sonoda: Recent Japanese aviation periodicals.
- PRUDENTIAL INSURANCE CO. OF AMERICA**, Newark, N. J.: Motion-picture film of the "You Are There" television program "Benjamin Franklin and His Kite."
- READ, ROBERT E.**, Alexandria, Va.: A contemporary poster of the editorial in the *New York Sun*, May 21, 1927, "Lindbergh Flies Alone."
- SEELEY, R. D.**, Fort Meade, Md.: A collection of photographs of foreign aircraft and engines, principally German and Italian types of World War II (loan).
- SHARP, JOHN R.**, Sioux Falls, S. Dak.: Book by this author listing Aces of World War I.
- UNITED AIRCRAFT CORPORATION**, East Hartford, Conn.: With the assistance of Harvey Lippincott, a file of the Corporation magazine *Bee Hive*, copies of the publication *Aerosphere*, and a selection of texts describing Pratt & Whitney aircraft engines.
- VERVILLE, ALFRED**, Washington, D. C.: Drawings and texts describing the Verville "Messenger" airplane, 1920.

ACCESSIONS

Additions to the National Aeronautical Collections received and recorded this year total 1,050 specimens in 33 separate accessions from 30 sources. Those from Government departments are entered as transfers; others were received as gifts except as noted.

- AIR FORCE, DEPARTMENT OF THE**, Washington, D. C.: Twin floats devised and constructed in 1907 by Orville and Wilbur Wright and tested on the Miami River, Dayton, Ohio, during experiments to develop a seaplane intended to be flown over the assembled world fleets at Hampton Roads, Va., during the Jamestown Exposition of that year, and a drawing illustrating that experiment (N. A. M. 945). Two dioramas, first received of a series illustrating the history of the United States Air Force. One diorama depicts a scene during the Civil War: the inflation of a captive balloon, piloted by T. S. C. Lowe and used for military observation of Confederate operations; the other diorama illustrates an important operation during World War II, after the capture of Finschafen, New Guinea, when a landing and takeoff strip had been prepared for use of Lockheed P-38 Lightning fighter planes (N. A. M. 946).

- ATCHISON, JOS. ANTHONY**, Washington, D. C.: Two paintings for an exhibit on Natural Flight, showing the extinct pterodactyl and the dragonfly (N. A. M. 918, purchased).
- BELL AIRCRAFT Co.**, Buffalo, N. Y.: VTOL aircraft (Vertical Take Off and Landing), developed by Lawrence Bell and associates in 1954. Fairchild J-44 engines, located each side of the fuselage, were pivoted into vertical position for direct upward takeoff, and after gaining altitude were rotated to horizontal position for forward thrust. A conventional wing provided lift for forward flight, and a French Palouste compressor provided air blasts at the wing tips and empennage for reaction control. Landings were made either by descending gradually during forward flight, or by pivoting the Fairchild engines into upright position and descending vertically (N. A. M. 943).
- BERLINER, COL. HENRY**, Washington, D. C.: Two wing ribs from the Wright brothers' airplane of 1908 which was the first to be demonstrated to Government officials at Fort Myer, Va., those demonstrations being suspended by the unfortunate accident of September 17, 1908; an Erco propeller blade of about 1945 formed of impregnated wood and plastic; and a portrait photograph of the donor's father, Emile Berliner, who, beginning about 1890, and continuing later with the assistance of his son, experimented with rocket-powered model airplanes, full-scale helicopters, and engines. The donor developed helicopters that achieved vertical lift, successful airplanes, and aeronautical equipment (N. A. M. 937).
- BOEING AIRPLANE Co.**, Seattle, Wash.: A scale model, 1:48 size, of the Boeing B-52 Air Force bomber which was the subject for the 1955 award of the Robert J. Collier Trophy (N. A. M. 933).
- BOLAND, JOSEPH, Frederick**, Md.: A scale model, constructed by himself, of the Boland Tailless Pusher airplane developed by him and his brothers at Rahway, N. J., 1909. It incorporates a unique "jib" control and was flown most notably by Frank Boland in Venezuela and Trinidad, 1912, it being the first aircraft to fly in those places (N. A. M. 917).
- BYRD, MRS. THOMAS, Boyce**, Va.: Plaster cast of the Congressional Medal awarded posthumously to Brig. Gen. William Mitchell, August 8, 1946, "for outstanding pioneer service and foresight in field of American military aviation." Sculptured by Erwin Springweiler (N. A. M. 927).
- CESSNA AIRCRAFT Co.**, Wichita, Kans.: Models, scale 1:36, of three airplanes: the Comet of 1911 developed by Clyde V. Cessna during the pioneer days of aeronautics; the Type 180, 4-seated high-wing monoplane introduced in 1953; and the Type 182, which is a 1956 improvement of the Type 180 having smoother flight characteristics (N. A. M. 936).
- COMMERCE, U. S. DEPARTMENT OF, NATIONAL BUREAU OF STANDARDS**, Washington, D. C.: A large and valuable collection of instruments dating back to the practical beginnings of aircraft instrumentation, including some types used with early lighter-than-air craft, compasses, engine instruments, navigation devices, fuel regulators, flight performance instruments, bombsights, and other equipment, both American and foreign. This material has been collected over the past 40 years or more in connection with the testing work of the Bureau's laboratories. The assistance of Dr. W. G. Brombacher in listing and identifying this collection is gratefully acknowledged (N. A. M. 924).
- GARBER, PAUL EDWARD**, Washington, D. C.: A Japanese "cricket" kite, embodying pouches and dihedral angles for stability made in 1956 (N.A.M. 915); a sculptured portrait of Dr. Samuel Pierpont Langley, third Secretary of the Smithsonian Institution, renowned astronomer, scientist, and pioneer of aviation; sculptured head by Joseph Anthony Atchison, 1957 (N. A. M. 939).

- GRUMMAN AIRCRAFT ENGINEERING CORPORATION, Bethpage, L. I., N. Y.: Two scale models, 1:16 size, of the Grumman F11F-1 "Tiger" airplane in current use as a Navy fighter. One of these models is shown with the Robert J. Collier Trophy, it being the first airplane to embody the Area Rule principle developed at the National Advisory Committee for Aeronautics laboratories by Richard Whitcomb who was recipient of that Trophy for the year 1954. The other model is in the series illustrating naval aircraft (N. A. M. 935).
- HAVEN, GILBERT P., Glastonbury, Conn.: Two load calculators, resembling a slide rule and used in determining the amount and dispositions of fuel, cargo, and other load factors to insure safe operation of aircraft. These are for B-17 and B-29 airplanes (N. A. M. 938).
- HUBBELL, CHARLES H., Cleveland, Ohio: Scale model, 1:16 size, of the Morane-Saulnier monoplane of 1914, one of the first fighter airplanes used by the French in World War I (N. A. M. 922, purchased).
- JERWAN, S. S., Philadelphia, Pa.: An autographed photograph of Admiral Richard E. Byrd, inscribed to the donor, who was a pioneer pilot of Moisant airplanes in 1910 (N. A. M. 931).
- KIRK, PRESTON, North Platte, Nebr.: Three aircraft engines, a British Bentley BR-2, rotary engine used in World War I pursuit planes; an American Lawrence 2-cylinder opposed A-3 used in training airplanes of the same period; and an American Irwin 4-cylinder radial developed in 1926 for light airplanes (N. A. M. 929).
- LEVER, HARRY, Washington, D. C.: A propeller blade from a Curtiss electric propeller, 13 feet diameter, made for a Convair CV240 transport plane, and an airplane bomb casing used for practice during World War II (N. A. M. 920).
- MARTIN Co., Baltimore, Md.: An oil painting by Charles Baskerville of Glenn L. Martin, the renowned aviation pioneer who died December 4, 1955 (N. A. M. 932).
- MCDONNELL AIRCRAFT CORP., St. Louis, Mo.: A scale model, 1:16 size, of the McDonnell F3H-2N "Demon" swept-wing single-place, all-weather jet fighter in current use by the U. S. Navy (N. A. M. 923).
- NATIONAL COLLECTION OF FINE ARTS, Smithsonian Institution, Washington, D. C.: A group of 16 framed portraits in chalk by John Elliott and four photographic prints of portraits by the same artist of members of the Lafayette Escadrille, a renowned group of American flyers who fought with the French in World War I (N. A. M. 921, loan).
- NAVY, DEPARTMENT OF THE, Washington, D. C.: The original insigne of the Naval Aircraft Factory, Philadelphia, Pa., organized during World War I, where many notable aircraft were developed and manufactured (N. A. M. 916). A Kaman K-225 helicopter, developed in 1948 and adopted the following year by the Navy as a utility type. Its rotor assembly is of the twin-intermeshing type, and its power was supplied by the Boeing 175-hp. YT-50 gas-turbine engine. The assistance of the Kaman Aircraft Corporation in conditioning this helicopter for Museum preservation is gratefully acknowledged (N. A. M. 940).
- NORTH AMERICAN AVIATION, INC., Columbus, Ohio: A scale model, 1:16 size, of the FJ-4 "Fury," naval fighter; the first aircraft developed by this division of this company, produced 1955. This airplane incorporates such advanced features as mechanically drooped leading edge, slotted flaps, and split ailerons (N. A. M. 934).
- PARKER, WILLIAM, Bartlesville, Okla.: The indicating unit of the radio compass used by Wiley Post during his extended substratosphere cross-country flights in the *Winnie Mae*, 1935 (N. A. M. 928).

- POTTER, STANLEY L., Alexandria, Va.: A diamond-celled box kite of the type invented by his father, Samuel Potter, who was a pioneer in the development of cellular kites and their use for meteorological research by the U. S. Weather Bureau (N. A. M. 914).
- ROYAL DANISH AERO CLUB, Copenhagen, Denmark, through His Excellency the Ambassador of Denmark, Henrik Kauffmann, Washington, D. C.: A scale model, 1:14 size, of the airplane designed, constructed, and flown by Jacob Christian Ellehammer on the island of Lindholm, September 12, 1906. The assistance of Erik Hildes-Heim in obtaining this model is gratefully acknowledged (N. A. M. 926).
- RYAN AERONAUTICAL CO., San Diego, Calif.: A scale model, 1:16 size, of the Ryan M-1 mailplane used on commercial postal aviation routes of the mid-1920's and the basic form of high-wing closed-fuselage monoplane from which the *Spirit of St. Louis* was evolved by the same company (N. A. M. 930).
- SPERRY GYROSCOPE CO., Great Neck, N. Y.: A scale model, 1:8 size, of the original "Aerial Torpedo," pilotless guided missile developed by the donors during the first World War (N. A. M. 919).
- TUSTAN, MICHAEL, Cleveland, Ohio: A scale model, 1:16 size, of the Pfalz D-3, German World War I fighter airplane introduced in the spring of 1917 and favored by some of the German Aces because of its maneuverability and strong construction (N. A. M. 941).
- VAGI, ERNEST F., Cleveland, Ohio: A scale model, 1:24 size, of the British F. E. 2B World War I two-seated fighter, developed by the Royal Aircraft Factory. Because its propeller was behind the wings, the gunner in the front seat had a wide angle of fire (N. A. M. 942).
- WHITNEY, CAPT. REGINALD, Baldwin, L. I., N. Y.: A Japanese aviator's flying suit used in World War II (N. A. M. 925).
- WISEMAN, MRS. S. A., Washington, D. C.: Four silver trophy cups awarded to the pioneer aviator Arthur L. Welsh in 1911 and a framed photograph of him and Robert J. Collier seated in a Wright-B airplane. Welsh was taught to fly by Orville Wright and became instructor and test pilot at the Wright School in Dayton. He taught Lt. H. H. Arnold (later General of the Air Force) how to fly. Welsh was killed in the crash of a Wright-C at College Park, Md., in 1912 (N. A. M. 944).

Respectfully submitted.

PAUL EDWARD GARBER, *Head Curator.*

Dr. LEONARD CARMICHAEL,
Secretary, Smithsonian Institution.

Report on the National Zoological Park

SIR: I have the honor to submit the following report on the activities of the National Zoological Park for the fiscal year ended June 30, 1957:

This has been a year of many changes in the administration of the Park, as four men in key positions reached the retirement age. The first to leave, on October 31, 1956, was Dr. William M. Mann, who had been Director of the National Zoological Park since 1925. During his term of office the number of animals in the collection increased from 1,600 to 3,000, much of the increase being due to collecting expeditions he headed. Under his direction three modern exhibition buildings were erected and a new wing was added to the bird house. Also built under his administration were the machine shops, garage, a new restaurant, and the building that houses the police headquarters and public restrooms. Dr. Mann's enthusiasm for his institution endeared him to friends all over the world. He remains in touch with the Zoo as Honorary Research Associate of the Smithsonian Institution. On June 11, 1957, the American Association of Zoological Parks and Aquariums honored Dr. Mann at a luncheon in the Zoo, paying tribute to his many years of leadership in zoological park management. Those attending from out of town were Lee Crandall, formerly Director of the New York Zoological Park; Freeman Shelly, Director of the Philadelphia Zoo; Roger Conant, Curator of Reptiles, Philadelphia Zoo; Clyde Gordon, Director of the Staten Island Zoo; and Roland Lindemann of the Catskill Game Farm, Catskill, N. Y.

The Assistant Director, Ernest P. Walker, retired on December 30, after nearly 27 years with the Zoo. As a mammalogist, especially interested in small mammals and wildlife conservation, his services were invaluable. He developed new diets for animals, and devised new methods of exhibiting them. He is continuing to write about mammals.

On February 28, Frank O. Lowe, head keeper, said farewell to the animal charges he had worked with for 48 years; and on April 2, Peter Hilt, superintendent of maintenance and construction, retired after 36 years with the Zoo. Both of these men were remarkably efficient in their fields and were respected and liked by the men who worked under them.

EXHIBITS

Plans for the future of the Zoo are to maintain a well-balanced zoological collection, with special emphasis on the exhibition and propa-

gation of North American animals, inasmuch as this is the National Zoological Park. The exhibition of exotics will not be neglected, but an attempt will be made to feature such animals as Rocky Mountain goats, Rocky Mountain sheep, prong-horned antelope, and other native species. Variety of species will be emphasized rather than numbers of individuals.

This year, for the first time, an outdoor exhibit of trained birds of prey was started. With the cooperation of local falconers, a red-tailed hawk and a Swainson's hawk were taken from the Zoo's collection and trained to a stoop and to the wrist. A duck hawk, or peregrine falcon, already trained, was presented by a falconer. The public has shown much interest in this new exhibit, where the birds are to be seen at close range and with no bars between them and the visitors.

Albinism, a curious phenomenon, has been prominent in 1957, and an unusual number of birds, mammals, and reptiles have their pink-eyed representatives within the present collection—in fact, to an extent seldom seen in zoos. The mathematical improbabilities of a male and female albino black snake meeting in their natural habitat are staggering, but such might be possible under zoo conditions. It is hoped that some interesting genetic implications may develop from these exhibits.

ACCESSIONS

A number of outstanding additions came to the Zoo this year. The most important was a pair of white or square-lipped rhinoceroses, (pl. 5, fig. 1), purchased from John Seago, an English collector, who had been trying for two years to secure them for the National Zoological Park. They were the first ever to come to this country and are still the only ones in the United States. Another purchase was a pair of snow leopards, commonly considered the most beautiful of the big cats. (Pl. 5, fig. 2.)

The Government of the Belgian Congo, through the Minister of Colonies, presented the National Zoological Park with a fine pair of okapis (pl. 6), the first ever to be exhibited here. They were flown from Leopoldville to Hanover, Germany, for a 60-day quarantine and then to the United States Quarantine Station at Athenia, N. J., for a 30-day quarantine. Upon arrival at the Zoo they were formally presented by Baron Leopold Dhanis, Counsel at the Belgian Embassy in Washington. With their glossy, dark-brown coats and striped legs they form an outstanding exhibit.

An inconspicuous small black bird, with red eyes, which was obtained from an animal dealer, turned out to be an ornithological prize. It is a Colombian red-eyed cowbird (*Tangavius armenti*),

which had not been observed since 1866 and was assumed by scientists to be extinct.

Six poisonous black-and-white-striped sea snakes (*Laticauda colubrina*) were obtained through the efforts of Frederick M. Bayer, of the United States National Museum. These are seldom seen in captivity, as they are difficult to keep. Shortly after their arrival here, one of them laid 15 eggs, attracting a great deal of interest, as most reference books state that sea snakes are viviparous. Disappointingly, none of the eggs hatched.

The United States Army Signal Corps, giving up its homing pigeon loft at Fort Monmouth, N. J., brought two hero pigeons to the Zoo. These birds, known as Anzio Boy and Global Girl, completed, between them, 61 important World War II missions in the Mediterranean area and were given citations by the Army. They have been placed in an outdoor cage, and an account of their military history appears on a large label nearby.

GIFTS

Other gifts of special interest were received from the following:

- | | |
|--|---|
| Ballou, George, New York, N. Y., 19 spiny mice (<i>Acomys</i>). | Kerwin, Charles H., Rockville, Md., Virginia deer. |
| Bonawit, George O., Suitland, Md., white-crested cockatoo. | Lichtenecker, Dr. Karl, Washington, D. C., collection of tropical fish and aquarium plants. |
| Broadhead, William S., Middleburg, Va., Azara's wild dog. | Martin, Mrs. Roy M., Winston-Salem, N. C., ocelot. |
| Brown, Mrs. Helen, Washington, D. C., black spider monkey. | McBride, W. W., Chevy Chase, Md., kinkajou. |
| Cleveland Wild Boar Club, Cleveland, Tenn., wild boar. | Medley, Miss Virginia, Washington, D. C., margay cat. |
| Coalson, H. B., Berryville, Va., spider monkey. | Muddiman, Buddy, Washington, D. C., collection of reptiles. |
| Dennis, Wesley, Warrenton, Va., emu. | Murphy, Robert, Westtown, Pa., duck hawk. |
| DePrato, Mario, Langley Park, Md., 125 hermit crabs, 7 turtles, 23 snakes, 6 frogs, 8 lizards, 1 toad. | National Aquarium Society, Washington, D. C., 2 black angelfish. |
| Du Pont, Irénée, Wilmington, Del., 4 Cuban iguanas. | Operation Deepfreeze, Washington, D. C., through Cmdr. F. Dustin, black swan. |
| Gasch, Manning, Forestville, Va., American bison. | Overton Park Zoo, Memphis, Tenn., 2 aningas. |
| Gianturco, Delio, Washington, D. C., Mexican spider monkey. | Pabst, G., Jr., Washington, D. C., 2 masked lovebirds. |
| Hamlett, George W., New Orleans, La., 3 western rattlesnakes. | Palmer, Miss Gaela, Chevy Chase, Md., macaque. |
| Harbaugh, George, Safeway Warehouse, Washington, D. C., 3 tarantulas and 2 cat-eyed snakes, which had come in on bunches of bananas. | Patuxent Research Refuge, Laurel, Md., through Dr. C. M. Herman, 8 partridges. |
| Hoffman, Irvin, Cabin John, Md., 2 Reeves's pheasants. | |

- | | |
|---|---|
| <p>Pifer, Ray F., Takoma Park, Md., collection of local snakes.</p> <p>Pittman, Miss Irma F., Washington, D. C., Indian hill mynah.</p> <p>Pope, Mrs. Esa B., Berryville, Va., 6 ring-necked pheasants, chukar quail.</p> <p>Rivero, Juan, Mayagüez, Cuba, 6 tree boas.</p> <p>Royal Zoological Society, Amsterdam, Holland, European stork.</p> <p>Sadler, Mrs. W. L., Monrovia, Liberia, golden cat (<i>Felis aurata</i>), and a small-clawed otter.</p> <p>Sand Lake National Wildlife Refuge, Oberon, S. Dak., 6 blue geese.</p> <p>Schmid, Paul F., Bethesda, Md., collection of local snakes.</p> <p>Shearer, Miss Julia, Locust Dale, Va., yellow-thighed caique.</p> <p>Sinsabaugh, Miss Doris, Washington, D. C., white-breasted toucan.</p> <p>Sorensen, H. P., El Paso, Tex., cockatiel.</p> | <p>Stewart, Mrs. Elizabeth, Washington, D. C., Florida gallinule.</p> <p>Sultan, W. E., Baltimore, Md., collection of tropical fish including the recently imported <i>Distichodus sexfasciatus</i>.</p> <p>Turner, William, Washington, D. C., marsh hawk.</p> <p>Wampler, Capt. French, Alexandria, Va., ringed aracari toucanet.</p> <p>Warner, Mrs. C. F., Washington, D. C., collection of reptiles.</p> <p>Welsh, Neal, Rockville, Md., collection of tropical fish.</p> <p>Wheeler, Mrs. T. E., Cheam, Surrey, England, 40 grass parakeets, a superior English strain of birds.</p> <p>Xanten, William R., Jr., Washington, D. C., collection of reptiles and a tarantula.</p> <p>Zoologisk Have, Copenhagen, Denmark, 2 European oystercatchers, 2 ruff shorebirds.</p> |
|---|---|

EXCHANGES

The Zoo often obtains specimens of interest through exchanges with other zoos or with private individuals. Worthy of mention this year are a black-and-white casqued hornbill, obtained from Dr. Lawrence Kilham, Bethesda, Md.; four roadrunners, from the San Antonio Zoo, San Antonio, Tex.; Todd's toucan, from William H. Paul, Washington, D. C.; a collection of Florida reptiles, from Lewis H. Babbitt, Petersham, Mass.; four peafowl from the San Diego Zoological Society, San Diego, Calif.; and an albino black snake, from Allan G. Dillon, Arlington, Va.

PURCHASES

Purchases of special interest not previously mentioned were as follows:

An African elephant, about 2½ years old, named Nancy. The Zoo had lacked the African species since the death of Jumbina.

A young Asiatic elephant, named Dixie, purchased as a companion for the young African elephant.

Seven hoopoes (pl. 7). These attractive European birds had not been in the collection before. They are now mating, and it is hoped some young birds can be raised.

A male hippopotamus, purchased as a mate for the female bought last year.

A hawk eagle, a rare species from Colombia.

| | |
|------------------------|------------------------------|
| Two jacanas. | A young giant anteater. |
| Two oropendolas. | Three red howler monkeys. |
| One Cayenne kite. | Two pygmy cormorants. |
| One blue toucan. | One blossom-headed parakeet. |
| Four giant tortoises. | Two slaty-headed parakeets. |
| Two African wild dogs. | 25 golden frogs. |

BIRTHS AND HATCHINGS

One of the signs that an animal is doing well in captivity is its ability to reproduce its kind and, as the following list shows, the number of mammals, birds, and reptiles born in the National Zoological Park during the year is gratifying:

MAMMALS

| Scientific name | Common name | Number |
|--|--------------------------------------|--------|
| <i>Pan satyrus</i> | Chimpanzee..... | 1 |
| <i>Cercopithecus aethiops sabaeus</i> | Guenon..... | 1 |
| <i>Cercopithecus neglectus</i> | DeBrazza's guenon..... | 1 |
| <i>Hylobates agilis</i> × <i>H. lar pileatus</i> | Hybrid gibbon..... | 1 |
| <i>Hylobates lar</i> | White-handed gibbon..... | 1 |
| <i>Choloepus didactylus</i> | Two-toed sloth..... | 1 |
| <i>Cynomys ludovicianus</i> | Prairie dog..... | 5 |
| <i>Phloeomys cumingi</i> | Slender-tailed cloud rat..... | 1 |
| <i>Hystrix galeata</i> | African porcupine..... | 1 |
| <i>Dasyprocta prymnolopha</i> | Agouti..... | 8 |
| <i>Vulpes fulva</i> | Red fox..... | 5 |
| <i>Atilax paludinosus</i> | Water civet..... | 1 |
| <i>Thalarcos maritimus</i> × <i>Ursus middendorffi</i> | Hybrid bear (second generation)..... | 3 |
| <i>Ursus horribilis</i> | Grizzly bear..... | 2 |
| <i>Felis leo</i> | Lion..... | 3 |
| <i>Equus burchelli boehmi</i> | Grant's zebra..... | 1 |
| <i>Lama glama</i> | Llama..... | 3 |
| <i>Axis axis</i> | Axis deer..... | 2 |
| <i>Cervus canadensis</i> | American elk..... | 1 |
| <i>Cervus elaphus</i> | Red deer..... | 1 |
| <i>Cervus nippon</i> | Sika deer..... | 2 |
| <i>Dama dama</i> | { Brown fallow deer..... | 2 |
| | { White fallow deer..... | 6 |
| <i>Odocoileus virginianus</i> | Virginia deer..... | 4 |
| <i>Odocoileus virginianus costaricensis</i> | Costa Rican deer..... | 1 |
| <i>Giraffa camelopardalis</i> | Nubian giraffe..... | 2 |
| <i>Bibos gaurus</i> | Gaur..... | 1 |
| <i>Anoa depressicornis</i> | Anoa..... | 1 |
| <i>Ammotragus oryia</i> | Aoudad or Barbary sheep..... | 2 |
| <i>Taurotragus oryx</i> | Eland..... | 1 |
| <i>Capra hircus</i> | Common goat..... | 2 |

BIRDS

| | | |
|--------------------------------------|-----------------------------|----|
| <i>Agapornis personata</i> | Masked lovebird..... | 1 |
| <i>Anas platyrhynchos</i> | Mallard duck..... | 12 |
| <i>Branta canadensis</i> | Canada goose..... | 10 |
| <i>Chauna torquata</i> | Crested screamer..... | 1 |
| <i>Chrysolophus pictus</i> | Golden pheasant..... | 5 |
| <i>Columba livia</i> | Pigeon..... | 2 |
| <i>Gennaeus leucomelanus</i> | Nepal kaleege pheasant..... | 1 |
| <i>Larus novaeollandiae</i> | Silver gull..... | 5 |
| <i>Melopsittacus undulatus</i> | Grass parakeet..... | 7 |

BIRDS—continued

| Scientific name | Common name | Number |
|--|--------------------------------|--------|
| <i>Munia oryzivora</i> | Java sparrow..... | 15 |
| <i>Nycticorax nycticorax hoactli</i> | Black-crowned night heron..... | 15 |
| <i>Taeniopygia castanotis</i> | Zebra finch..... | 10 |
| <i>Tigrisoma lineatum</i> | Tiger bittern..... | 2 |

REPTILES

| | | |
|--|------------------------|----|
| <i>Chamaeleon bitaeniatus hoehneli</i> | African chameleon..... | 21 |
| <i>Chelydra serpentina</i> | Snapping turtle..... | 6 |
| <i>Chrysemys picta</i> | Painted turtle..... | 10 |
| <i>Epicrates angulifer</i> | Cuban tree boa..... | 2 |
| <i>Lampropeltis getulus</i> | King snake..... | 2 |
| <i>Natrix sipedon</i> | Water snake..... | 21 |
| <i>Pseudemys scripta</i> | Red-lined turtle..... | 11 |
| <i>Storeria dekayi</i> | DeKay's snake..... | 45 |

The total number of accessions for the year was 1,851. This includes gifts, purchases, exchanges, deposits, births, and hatchings. Space is too limited to list here the numbers of ducks, chickens, and rabbits, usually given to children at Easter time, which eventually find their way to the Zoo, or such pets as monkeys, parakeets, alligators, caimans, and guinea pigs. Many of the common local wild things are found by persons, often children, who, thinking the creatures need help, bring them to the Zoo. They include gray squirrels, cottontail rabbits, opossums, raccoons, foxes, woodchucks, blue jays, robins, sparrows, box turtles, and other less plentiful forms. Some are kept, some are exchanged, and some are liberated.

STATUS OF THE COLLECTION

| Class | Species or subspecies | Individuals |
|---|-----------------------|-------------|
| Mammals..... | 289 | 696 |
| Birds..... | 307 | 1,251 |
| Reptiles..... | 166 | 864 |
| Fish..... | 25 | 97 |
| Arthropods..... | 6 | 149 |
| Mollusks..... | 1 | 100 |
| Total..... | 794 | 3,157 |
| Animals on hand July 1, 1956..... | | 2,965 |
| Accessions during the year..... | | 1,851 |
| Total number of animals in collection during the year..... | | 4,816 |
| Removals for various reasons such as death, exchanges, return of animals on deposit, etc..... | | 1,659 |
| In collection on June 30, 1957..... | | 3,157 |

ANIMALS IN THE COLLECTION ON JUNE 30, 1957

MAMMALS

MONOTREMATA

| Scientific name | Common name | Number |
|-------------------------------------|---------------------------------|--------|
| Tachyglossidae: | | |
| <i>Tachyglossus aculeatus</i> | Echidna, or spiny anteater..... | 2 |

MARSUPIALIA

| | | |
|---|------------------------------|---|
| Didelphiidae: | | |
| <i>Caluromys philander</i> | Woolly opossum..... | 1 |
| <i>Didelphis marsupialis virginiana</i> | Opossum..... | 1 |
| Phalangeridae: | | |
| <i>Petaurus norfolcensis</i> | Lesser flying phalanger..... | 3 |
| <i>Trichosurus vulpecula</i> | Vulpine opossum..... | 1 |
| Phascologyidae: | | |
| <i>Lasiorhinus latifrons</i> | Hairy-nosed wombat..... | 2 |
| <i>Vombatus hirsutus</i> | Mainland wombat..... | 1 |
| Macropodidae: | | |
| <i>Dendrolagus inustus</i> | Tree kangaroo..... | 1 |
| <i>Hypsiprymnodon moschatus</i> | Rat kangaroo..... | 6 |
| <i>Macropus giganteus</i> | Gray kangaroo..... | 2 |
| <i>Macropus rufus</i> | Red kangaroo..... | 1 |
| <i>Protemnodon agilis</i> | Wallaby..... | 1 |
| <i>Protemnodon bicolor</i> | Swamp wallaby..... | 1 |

PRIMATES

| | | |
|---|---|----|
| Lorisidae: | | |
| <i>Galago crassicaudatus</i> | Galago..... | 4 |
| <i>Galago senegalensis</i> | African galago..... | 2 |
| <i>Nycticebus coucang</i> | Slow loris..... | 3 |
| Lemuridae: | | |
| <i>Lemur mongoz</i> | Mongooz lemur..... | 1 |
| Cebidae: | | |
| <i>Aotus trivirgatus</i> | Night monkey..... | 5 |
| <i>Ateles fusciceps robustus</i> | Colombian black spider monkey..... | 1 |
| <i>Ateles geoffroyi geoffroyi</i> or <i>griscens</i> | Spider monkey..... | 3 |
| <i>Ateles geoffroyi vellerosus</i> | Spider monkey..... | 2 |
| <i>Cacajao rubicundus</i> | Red uakari..... | 1 |
| <i>Cebus capucinus</i> | { Brown capuchin monkey..... White-throated capuchin monkey..... Capuchin monkey..... } | 15 |
| <i>Lagothrix pygmaea</i> | Woolly monkey..... | 2 |
| <i>Saimiri sciureus</i> | Squirrel monkey..... | 4 |
| Callithricidae: | | |
| <i>Callithrix</i> sp..... | Red-mantled marmoset..... | 4 |
| <i>Cebuella pygmaea</i> | Pigmy marmoset..... | 1 |
| <i>Leontocebus rosalia</i> | Golden marmoset..... | 1 |
| <i>Mariquina nigricollis</i> | Black and red marmoset..... | 1 |
| Cercopithecidae: | | |
| <i>Allenopithecus nigroviridis</i> | Allen's monkey..... | 3 |
| <i>Cercocebus albigena</i> | Gray-cheeked mangabey..... | 1 |
| <i>Cercocebus aterrimus</i> | Black-crested mangabey..... | 4 |
| <i>Cercocebus aterrimus opdenboschii</i> | Crested mangabey..... | 1 |
| <i>Cercocebus chrysogaster</i> | Golden-bellied mangabey..... | 1 |
| <i>Cercocebus fuliginosus</i> | Sooty mangabey..... | 4 |
| <i>Cercocebus galeritus agilis</i> | Agile mangabey..... | 1 |
| <i>Cercocebus torquatus</i> | Red-crowned mangabey..... | 2 |
| <i>Cercopithecus aethiops sabaesus</i> | Green guenon..... | 8 |
| <i>Cercopithecus aethiops sabaesus</i> × <i>C. a. pygerythrus</i> | Hybrid, green guenon × vervet guenon..... | 2 |
| <i>Cercopithecus cephus</i> | Mustached monkey..... | 3 |
| <i>Cercopithecus diana</i> | Diana monkey..... | 3 |
| <i>Cercopithecus diana roloway</i> | Roloway monkey..... | 1 |

MAMMALS—Continued

PRIMATES—continued

| <i>Scientific name</i> | <i>Common name</i> | <i>Number</i> |
|--|-----------------------------------|---------------|
| Cercopithecidae—Continued | | |
| <i>Cercopithecus neglectus</i> | De Brazza's guenon..... | 3 |
| <i>Cercopithecus nictitans</i> | White-nosed guenon..... | 1 |
| <i>Cercopithecus nictitans petaurista</i> | Lesser white-nosed guenon..... | 1 |
| <i>Cercopithecus preussi</i> | Preussi's guenon..... | 1 |
| <i>Macaca irus mordax</i> | Javan macaque..... | 1 |
| <i>Macaca lasiote</i> | Chinese macaque..... | 1 |
| <i>Macaca maurus</i> | Moor macaque..... | 2 |
| <i>Macaca mulatta</i> | Rhesus monkey..... | 5 |
| <i>Macaca nemestrina</i> | Pig-tailed monkey..... | 1 |
| <i>Macaca philippinensis</i> | Philippine macaque..... | 1 |
| <i>Macaca sinica</i> | Toque or bonnet monkey..... | 2 |
| <i>Macaca speciosa</i> | Red-faced macaque..... | 1 |
| <i>Macaca sylvanus</i> | Barbary ape..... | 9 |
| <i>Mandrillus sphinx</i> | Mandrill..... | 2 |
| <i>Papio comatus</i> | Chacma baboon..... | 1 |
| <i>Papio cynocephalus</i> | Golden baboon..... | 2 |
| <i>Papio hamadryas</i> | Hamadryas baboon..... | 1 |
| <i>Presbytis phayrei</i> | Spectacled langur..... | 1 |
| <i>Theropithecus gelada</i> | Gelada baboon..... | 1 |
| Pongidae: | | |
| <i>Gorilla gorilla</i> | Gorilla..... | 2 |
| <i>Hylobates agilis</i> × <i>H. lar pileatus</i> | Hybrid gibbon..... | 1 |
| <i>Hylobates hoolock</i> | Hoolock..... | 1 |
| <i>Hylobates lar</i> | White-handed gibbon..... | 6 |
| <i>Hylobates moloch</i> | Wau-wau gibbon..... | 1 |
| <i>Pan satyrus</i> | Chimpanzee..... | 12 |
| <i>Pongo pygmaeus abelii</i> | Bornean orangutan..... | 1 |
| <i>Pongo pygmaeus pygmaeus</i> | Sumatran orangutan..... | 2 |
| EDENTATA | | |
| Myrmecophagidae: | | |
| <i>Myrmecophaga tridactyla</i> | Giant anteater..... | 2 |
| Bradypodidae: | | |
| <i>Choloepus didactylus</i> | Two-toed sloth..... | 5 |
| Dasypodidae: | | |
| <i>Dasypus novemcinctus</i> | Nine-banded armadillo..... | 1 |
| LAGOMORPHA | | |
| Leporidae: | | |
| <i>Oryctolagus cuniculus</i> | Domestic rabbit..... | 12 |
| <i>Sylvilagus floridanus</i> | Cottontail rabbit..... | 2 |
| RODENTIA | | |
| Sciuridae: | | |
| <i>Callosciurus nigrovittatus</i> | Southern Asiatic squirrel..... | 8 |
| <i>Cynomys ludovicianus</i> | Prairie dog..... | 25 |
| <i>Glaucomys volans volans</i> | Eastern flying squirrel..... | 5 |
| <i>Marmota monax</i> | Groundhog..... | 1 |
| <i>Ratufa indica</i> | Giant Indian squirrel..... | 1 |
| <i>Sciurus carolinensis</i> | Gray squirrel, albino..... | 1 |
| <i>Sciurus niger</i> | Fox squirrel..... | 1 |
| <i>Sciurus variegatus</i> | Mexican red-bellied squirrel..... | 1 |
| <i>Tamias striatus</i> | Eastern chipmunk, albino..... | 1 |
| Cricetidae: | | |
| <i>Mesocricetus auratus</i> | Hamster..... | 8 |
| Muridae: | | |
| <i>Acomys cahirinus</i> | Egyptian spiny mouse..... | 16 |
| <i>Cricetomys gambianus</i> | Giant pouched rat..... | 4 |
| <i>Meriones unguiculatus</i> | Mongolian gerbil..... | 2 |
| <i>Phloeomys cumingi</i> | Slender-tailed cloud rat..... | 5 |

MAMMALS—Continued

RODENTIA—continued

| Scientific name | Common name | Number |
|---------------------------------------|----------------------------------|--------|
| Gliridae: | | |
| <i>Graphiurus murinus</i> | Dormouse..... | 1 |
| Hystriidae: | | |
| <i>Acanthion brachyura</i> | Malay porcupine..... | 1 |
| <i>Hystrix galeata</i> | African porcupine..... | 6 |
| Erethizontidae: | | |
| <i>Coendou prehensilis</i> | Prehensile-tailed porcupine..... | 1 |
| Caviidae: | | |
| <i>Cavia porcellus</i> | Guinea-pig..... | 16 |
| Hydrochoeridae: | | |
| <i>Hydrochoerus hydrochoeri</i> | Capybara..... | 3 |
| Dasyproctidae: | | |
| <i>Cuniculus paca</i> | Paca..... | 4 |
| <i>Dasyprocta punctata</i> | Speckled agouti..... | 7 |
| Chinchillidae: | | |
| <i>Chinchilla chinchilla</i> | Chinchilla..... | 3 |
| <i>Lagidium viscaccia</i> | Peruvian viscaccia..... | 1 |
| Capromyidae: | | |
| <i>Myocastor coypus</i> | Coypu..... | 2 |

CARNIVORA

| | | |
|---|------------------------------|----|
| Canidae: | | |
| <i>Canis antarcticus</i> | Dingo..... | 1 |
| <i>Canis lupus nubilus</i> | Timber wolf..... | 4 |
| <i>Canis niger rufus</i> | Red wolf..... | 1 |
| <i>Cerdocyon thous</i> | South American fox..... | 1 |
| <i>Fennecus zerda</i> | Fennee fox..... | 2 |
| <i>Lycaon pictus</i> | African hunting dog..... | 2 |
| <i>Nyctereutes procyonoides</i> | Raccoon dog..... | 6 |
| <i>Otocyon megalotis</i> | Big-eared fox..... | 4 |
| <i>Speothos venaticus</i> | Bush dog..... | 2 |
| <i>Urocyon cinereoargenteus</i> | Gray fox..... | 8 |
| <i>Vulpes fulva</i> | { Red fox..... | 13 |
| | { Platinum fox..... | 3 |
| Ursidae: | | |
| <i>Euarctos americanus</i> | Black bear..... | 2 |
| <i>Helarctos malayanus</i> | Malay sun bear..... | 3 |
| <i>Selenarctos thibetanus</i> | Himalayan bear..... | 2 |
| <i>Selenarctos thibetanus japonicus</i> | Japanese black bear..... | 1 |
| <i>Selenarctos thibetanus ussuricus</i> | Korean bear..... | 2 |
| <i>Thalarctos maritimus</i> | Polar bear..... | 1 |
| <i>Thalarctos maritimus</i> × <i>Ursus middendorffi</i> | Hybrid bear..... | 4 |
| <i>Tremarctos ornatus</i> | Spectacled bear..... | 1 |
| <i>Ursus sp.</i> | Alaskan brown bear..... | 1 |
| <i>Ursus arctos</i> | European brown bear..... | 4 |
| <i>Ursus arctos occidentalis</i> | Syrian brown bear..... | 2 |
| <i>Ursus gyas</i> | Alaskan Peninsula bear..... | 2 |
| <i>Ursus horribilis</i> | Grizzly bear..... | 2 |
| <i>Ursus middendorffi</i> | Kodiak bear..... | 1 |
| <i>Ursus silkensis</i> | Sitka brown bear..... | 2 |
| Procyonidae: | | |
| <i>Ailurus fulgens</i> | Lesser panda..... | 2 |
| <i>Bassaricyon gabbi</i> | Olingo..... | 1 |
| <i>Bassariscus astutus</i> | Ringtail, or cacomistle..... | 1 |
| <i>Nasua narica</i> | Coatimundi..... | 1 |
| <i>Nasua nasua</i> | Red coatimundi..... | 2 |
| <i>Potos flavus</i> | Kinkajou..... | 3 |
| <i>Procyon lotor</i> | Raccoon..... | 13 |
| Mustelidae: | | |
| <i>Lutra cinerea</i> | African clawed otter..... | 1 |
| <i>Mephitis mephitis</i> | Common skunk..... | 1 |
| <i>Mustela eversmanni</i> | Ferret, albino..... | 1 |

MAMMALS—Continued

CARNIVORA—continued

| <i>Scientific name</i> | <i>Common name</i> | <i>Number</i> |
|--|---------------------------------------|---------------|
| Mustelidae—Continued | | |
| <i>Mustela frenata</i> | Weasel..... | 1 |
| <i>Pteronura brasiliensis</i> | South American flat-tailed otter..... | 1 |
| <i>Spilogale phenax</i> | California spotted skunk..... | 3 |
| <i>Taxidea taxus</i> | American badger..... | 1 |
| <i>Tayra barbara</i> | Tayra..... | 1 |
| Cryptoproctidae: | | |
| <i>Cryptoprocta ferox</i> | Fossa..... | 1 |
| Viverridae: | | |
| <i>Arctictis binturong</i> | Binturong..... | 1 |
| <i>Atilax paludinosus</i> | Water civet..... | 3 |
| <i>Genetta genetta</i> | Genet..... | 2 |
| <i>Genetta genetta neumanni</i> | Genet..... | 2 |
| <i>Herpestes ichneumon</i> | African civet..... | 2 |
| <i>Ichneumia albicauda</i> | White-tailed civet..... | 2 |
| <i>Paguma larvata taiwana</i> | Formosan masked civet..... | 1 |
| <i>Viverra zangalunga</i> | Ground civet..... | 1 |
| Hyaenidae: | | |
| <i>Crocuta crocuta germinans</i> | Spotted hyena..... | 2 |
| <i>Hyaena hyaena</i> | Striped hyena..... | 2 |
| Felidae: | | |
| <i>Acinonyx jubata</i> | Cheetah..... | 2 |
| <i>Felis chaus</i> | Jungle cat..... | 2 |
| <i>Felis concolor</i> | Puma..... | 4 |
| <i>Felis leo</i> | Lion..... | 9 |
| <i>Felis onca</i> | Jaguar..... | 3 |
| <i>Felis pajeros</i> | Pampas cat..... | 1 |
| <i>Felis pardalis</i> | Ocelot..... | 2 |
| <i>Felis pardus</i> | { African leopard..... | 3 |
| | { Black leopard..... | 2 |
| <i>Felis serval</i> | Serval cat..... | 1 |
| <i>Felis sylvestris</i> | African wildcat..... | 2 |
| <i>Felis tigrina</i> | Margay cat..... | 2 |
| <i>Felis tigris</i> | Bengal tiger..... | 3 |
| <i>Felis uncia</i> | Snow leopard..... | 2 |
| <i>Lynx canadensis</i> | Lynx..... | 1 |
| <i>Lynx rufus</i> | Bobcat..... | 2 |

PINNIPEDIA

| | | |
|-------------------------------------|--------------------------|---|
| Otariidae: | | |
| <i>Otaria flavescens</i> | Patagonian sea-lion..... | 2 |
| <i>Zalophus californianus</i> | Sea-lion..... | 2 |
| Phocidae: | | |
| <i>Phoca vitulina</i> | Harbor seal..... | 2 |

TUBULIDENTATA

| | | |
|-------------------------------|---------------------------|---|
| Orycteropodidae: | | |
| <i>Orycteropus afer</i> | Antbear, or aardvark..... | 1 |

PROBOSCIDEA

| | | |
|---------------------------------|-----------------------|---|
| Elephantidae: | | |
| <i>Elephas maximus</i> | Indian elephant..... | 3 |
| <i>Loxodonta africana</i> | African elephant..... | 1 |

PERISSODACTYLA

| | | |
|---|---------------------------------|---|
| Equidae: | | |
| <i>Equus asinus</i> | Burro, or donkey..... | 1 |
| <i>Equus burchelli antiquorum</i> | Chapman's zebra..... | 1 |
| <i>Equus burchelli boehmi</i> | Grant's zebra..... | 4 |
| <i>Equus grevy</i> | Grevy's zebra..... | 3 |
| <i>Equus kiang</i> | Asiatic wild ass, or kiang..... | 1 |
| <i>Equus przewalskii</i> | Mongolian wild horse..... | 1 |

MAMMALS—Continued

PERISSODACTYLA—continued

| Scientific name | Common name | Number |
|-----------------------------------|---|--------|
| Tapiridae: | | |
| <i>Acrocodia indica</i> | Indian tapir..... | 1 |
| <i>Tapirus terrestris</i> | Brazilian tapir..... | 1 |
| Rhinocerotidae: | | |
| <i>Ceratotherium simum</i> | White or square-mouth rhinoceros..... | 2 |
| <i>Diceros bicornis</i> | African rhinoceros..... | 2 |
| <i>Rhinoceros unicornis</i> | Great Indian one-horned rhinoceros..... | 1 |

ARTIODACTYLA

| | | |
|---|--------------------------------------|----|
| Suidae: | | |
| <i>Sus scrofa</i> | European wild boar..... | 2 |
| Tayassuidae: | | |
| <i>Pecari tajacu angulatus</i> | Collared peccary..... | 2 |
| Hippopotamidae: | | |
| <i>Choeropsis liberiensis</i> | Pygmy hippopotamus..... | 4 |
| <i>Hippopotamus amphibius</i> | Hippopotamus..... | 4 |
| Camelidae: | | |
| <i>Camelus bactrianus</i> | Bactrian camel..... | 2 |
| <i>Camelus dromedarius</i> | Single-humped camel..... | 1 |
| <i>Lama glama</i> | Llama..... | 6 |
| <i>Lama glama guanicoe</i> | Guanaco..... | 3 |
| <i>Lama pacos</i> | Alpaca..... | 4 |
| Cervidae: | | |
| <i>Axis axis</i> | Axis deer..... | 6 |
| <i>Cervus canadensis</i> | American elk..... | 5 |
| <i>Cervus elaphus</i> | Red deer..... | 2 |
| <i>Cervus nippon</i> | Sika deer..... | 10 |
| <i>Cervus nippon manchuricus</i> | Dybowsky's deer..... | 2 |
| <i>Dama dama</i> | { Brown fallow deer..... | 16 |
| | { White fallow deer..... | 17 |
| <i>Elaphurus davidianus</i> | Père David's deer..... | 2 |
| <i>Hydropotes inermis</i> | Chinese water deer..... | 3 |
| <i>Muntiacus muntjak</i> | Rib-faced deer..... | 1 |
| <i>Odocoileus virginianus</i> | Virginia deer..... | 17 |
| <i>Odocoileus virginianus costaricensis</i> | Costa Rican deer..... | 3 |
| Giraffidae: | | |
| <i>Giraffa camelopardalis</i> | Nubian giraffe..... | 4 |
| <i>Okapia johnstoni</i> | Okapi..... | 2 |
| Antilocapridae: | | |
| <i>Antilocapra americana</i> | Pronghorn antelope..... | 1 |
| Bovidae: | | |
| <i>Ammotragus lervia</i> | Aoudad..... | 14 |
| <i>Anoa depressicornis</i> | Anoa..... | 3 |
| <i>Bibos gaurus</i> | Gaur..... | 4 |
| <i>Bison bison</i> | American bison..... | 8 |
| <i>Bison bonasus</i> | European bison, or wisent..... | 2 |
| <i>Bos indicus</i> | Zebu..... | 2 |
| <i>Bos taurus</i> | { West Highland or Kylee cattle..... | 4 |
| | { British Park cattle..... | 6 |
| <i>Capra aegagrus cretensis</i> | Cretan agrimi goat..... | 1 |
| <i>Capra hircus</i> | Domestic goat..... | 5 |
| <i>Cephalophus nigrifrons</i> | Black-fronted duiker..... | 1 |
| <i>Hemitragus jemtahicus</i> | Tahr..... | 2 |
| <i>Ovis musimon</i> | Mouflon..... | 2 |
| <i>Poephagus grunniens</i> | Yak..... | 5 |
| <i>Pseudois nayaur</i> | Blue sheep..... | 1 |
| <i>Saiga tatarica</i> | Saiga antelope..... | 1 |
| <i>Syncerus caffer</i> | African buffalo..... | 2 |
| <i>Taurotragus oryz</i> | Eland..... | 2 |

BIRDS

STRUTHIONIFORMES

| <i>Scientific name</i> | <i>Common name</i> | <i>Number</i> |
|-------------------------------|--------------------|---------------|
| Struthionidae: | | |
| <i>Struthio camelus</i> | Ostrich..... | 1 |

RHEIFORMES

| | | |
|-----------------------------|-----------|---|
| Rheidae: | | |
| <i>Rhea americana</i> | Rhea..... | 2 |

CASUARIIFORMES

| | | |
|--|----------------------------|---|
| Casuariidae: | | |
| <i>Casuarus unappendiculatus unap-</i> <i>pendiculatus.</i> | One-wattled cassowary..... | 1 |
| Dromiceidae: | | |
| <i>Dromiceius novaehollandiae</i> | Emu..... | 5 |

TINAMIFORMES

| | | |
|----------------------------|------------------------------|---|
| Tinamidae: | | |
| <i>Tinamus major</i> | Chestnut-headed tinamou..... | 1 |

SPHENISCIFORMES

| | | |
|-------------------------------------|-------------------------|---|
| Spheniscidae: | | |
| <i>Aptenodytes patagonica</i> | King penguin..... | 4 |
| <i>Pygoscelis adeliae</i> | Adelie penguin..... | 1 |
| <i>Spheniscus humboldti</i> | Humboldt's penguin..... | 2 |

PELICANIFORMES

| | | |
|--|---------------------------|---|
| Pelecanidae: | | |
| <i>Pelecanus erythrorhynchus</i> | White pelican..... | 7 |
| <i>Pelecanus occidentalis occidentalis</i> ... | Brown pelican..... | 2 |
| <i>Pelecanus onocrotalus</i> | Rose-colored pelican..... | 2 |
| Phalacrocoracidae: | | |
| <i>Phalacrocorax auritus albociliatus</i> ... | Farallon cormorant..... | 1 |

CICONIIFORMES

| | | |
|--|--------------------------------|----|
| Ardeidae: | | |
| <i>Florida caerulea</i> | Blue heron..... | 2 |
| <i>Leucophoyx thula</i> | Snowy egret..... | 2 |
| <i>Notophoyx novaehollandiae</i> | White-faced heron..... | 1 |
| <i>Nycticorax nycticorax hoacili</i> | Black-crowned night heron..... | 24 |
| <i>Tigrisoma lineatum</i> | Tiger bittern..... | 4 |
| Balaenicipitidae: | | |
| <i>Balaeniceps rex</i> | Shoebill..... | 1 |
| Cochleariidae: | | |
| <i>Cochlearius cochlearius</i> | Boat-billed heron..... | 3 |
| Ciconiidae: | | |
| <i>Dissoura episcopus</i> | Woolly-necked stork..... | 1 |
| <i>Leptoptilus crumeniferus</i> | Marabou stork..... | 1 |
| <i>Leptoptilus javanicus</i> | Lesser adjutant..... | 2 |
| Threskiornithidae: | | |
| <i>Ajaja ajaja</i> | Roseate spoonbill..... | 2 |
| <i>Eudocimus alba</i> | White ibis..... | 4 |
| <i>Eudocimus ruber</i> | Scarlet ibis..... | 2 |
| <i>Mycteria americana</i> | Wood ibis..... | 1 |
| <i>Threskiornis melanocephala</i> | Black-headed ibis..... | 1 |
| Phoenicopteridae: | | |
| <i>Phoenicopterus antiquorum</i> | Old World flamingo..... | 1 |
| <i>Phoenicopterus chilensis</i> | Chilean flamingo..... | 2 |
| <i>Phoenicopterus ruber</i> | Cuban flamingo..... | 1 |

BIRDS—Continued

ANSERIFORMES

| Scientific name | Common name | Number |
|--|---|--------|
| Anhimidae: | | |
| <i>Chauna torquata</i> | Crested screamer..... | 4 |
| Anatidae: | | |
| <i>Aix sponsa</i> | Wood duck..... | 9 |
| <i>Aix sponsa</i> × <i>Aythya americana</i> | Hybrid, wood duck × red-headed duck..... | 2 |
| <i>Anas acuta</i> | Pintail duck..... | 4 |
| <i>Anas discors</i> | Blue-winged teal..... | 1 |
| <i>Anas platyrhynchos</i> | Mallard duck..... | 57 |
| | Rouen duck..... | 8 |
| | White mallard duck..... | 1 |
| <i>Anas platyrhynchos</i> × <i>A. acuta</i> | Hybrid, mallard duck × American pintail duck..... | 1 |
| <i>Anas platyrhynchos</i> × <i>A. p. domestica</i> | Hybrid, mallard × Peking duck..... | 20 |
| <i>Anas platyrhynchos domestica</i> | Peking duck..... | 102 |
| <i>Anas poecilorhyncha</i> | Indian spotted-bill duck..... | 1 |
| <i>Anas rubripes</i> | Black duck..... | 1 |
| <i>Anser albifrons</i> | White-fronted goose..... | 3 |
| <i>Anser anser domesticus</i> | Domestic Chinese goose..... | 7 |
| <i>Anseranus semipalmata</i> | Australian pied goose..... | 1 |
| <i>Aythya americana</i> | Red-headed duck..... | 4 |
| <i>Aythya valisineria</i> | Canvasback duck..... | 3 |
| <i>Branta canadensis</i> | Canada goose..... | 40 |
| <i>Branta canadensis canadensis</i> × <i>Chen caerulescens</i> | Hybrid, Canada goose × blue goose..... | 2 |
| <i>Branta canadensis minima</i> | Cackling goose..... | 13 |
| <i>Branta canadensis occidentalis</i> | White-cheeked goose..... | 27 |
| <i>Cairina moschata</i> | Muscovy duck..... | 7 |
| <i>Cereopsis novaehollandiae</i> | Cape Barren goose..... | 1 |
| <i>Chen allantica</i> | Snow goose..... | 7 |
| <i>Chen caerulescens</i> | Blue goose..... | 6 |
| <i>Chen hyperborea</i> | Lesser snow goose..... | 2 |
| <i>Chen rossi</i> | Ross's goose..... | 4 |
| <i>Chenopsis atrata</i> | Black swan..... | 4 |
| <i>Chloephaga leucoptera</i> | Upland goose..... | 1 |
| <i>Cygnus columbianus</i> | Whistling swan..... | 5 |
| <i>Cygnus cygnus</i> | Whooper swan..... | 2 |
| <i>Dendrocygna autumnalis</i> | Black-bellied tree duck..... | 30 |
| <i>Dendronessa galericulata</i> | Mandarin duck..... | 2 |
| <i>Eulabeia indica</i> | Indian bar-headed goose..... | 5 |
| <i>Mareca americana</i> | Baldpate..... | 1 |
| <i>Netta rufina</i> | Red-crested pochard..... | 1 |
| <i>Nyroca affinis</i> | Lesser scaup..... | 1 |
| <i>Philacte canagica</i> | Emperor goose..... | 2 |
| <i>Plectropterus gambensis</i> | Spur-winged goose..... | 1 |
| <i>Sarkidiornis melanota</i> | Comb duck..... | 1 |
| <i>Somateria mollissima</i> | Eider duck..... | 1 |
| <i>Tadorna tadorna</i> | European shell duck..... | 1 |

FALCONIFORMES

| | | |
|---------------------------------------|---------------------------|---|
| Cathartidae: | | |
| <i>Cathartes aura</i> | Turkey vulture..... | 4 |
| <i>Coragyps atratus</i> | Black vulture..... | 6 |
| <i>Gyps rueppelli</i> | Riippell's vulture..... | 2 |
| <i>Pseudogyps africanus</i> | White-backed vulture..... | 1 |
| <i>Sarcoramphus papa</i> | King vulture..... | 1 |
| Sagittariidae: | | |
| <i>Sagittarius serpentarius</i> | Secretarybird..... | 2 |

BIRDS—Continued

FALCONIFORMES—continued

| Scientific name | Common name | Number |
|--|---------------------------------|--------|
| Accipitridae: | | |
| <i>Buteo jamaicensis</i> | Red-tailed hawk..... | 6 |
| <i>Buteo lineatus</i> | Red-shouldered hawk..... | 1 |
| <i>Buteo poecliochrous</i> | Buzzard eagle..... | 1 |
| <i>Butea swainsoni</i> | Swainson's hawk..... | 1 |
| <i>Haliaeetus leucocephalus</i> | Bald eagle..... | 8 |
| <i>Haliaeetus leucogaster</i> | White-breasted sea eagle..... | 1 |
| <i>Haliaastur indus</i> | Brahminy kite..... | 1 |
| <i>Harpia harpyja</i> | Harpy eagle..... | 1 |
| <i>Leptodon cayanensis</i> | Cayenne kite..... | 1 |
| <i>Milvago chimango</i> | Chimango..... | 1 |
| <i>Milvus migrans parasitus</i> | African yellow-billed kite..... | 2 |
| <i>Morphnus guianensis</i> | Guianan crested eagle..... | 1 |
| <i>Pandion haliaeetus carolinensis</i> | Osprey..... | 3 |
| <i>Pithecophagus jefferyi</i> | Monkey-eating eagle..... | 1 |
| <i>Spizaetus ornatus</i> | Manduit's hawk-eagle..... | 1 |
| Falconidae: | | |
| <i>Falco mexicanus</i> | Prairie falcon..... | 1 |
| <i>Falco peregrinus anatum</i> | Duck hawk..... | 1 |
| <i>Falco sparverius</i> | Sparrow hawk..... | 6 |
| <i>Polyborus plancus</i> | South American caracara..... | 3 |

GALLIFORMES

| | | |
|---|-------------------------------------|---|
| Megapodiidae: | | |
| <i>Alectura lathamii</i> | Brush turkey..... | 1 |
| Cracidae: | | |
| <i>Craz alberti</i> | Blue-cered curassow..... | 2 |
| <i>Craz globulosa</i> | Wattled curassow..... | 2 |
| <i>Craz panamensis</i> | Panama curassow..... | 1 |
| Phasianidae: | | |
| <i>Alectornis graeca</i> | Chukar quail..... | 5 |
| <i>Argusianus argus</i> | Argus pheasant..... | 1 |
| <i>Chrysolophus amherstiae</i> | Lady Amherst pheasant..... | 3 |
| <i>Chrysolophus pictus</i> | Golden pheasant..... | 8 |
| <i>Colinus virginianus</i> | { Bobwhite quail..... | 3 |
| | { Red bobwhite quail..... | 1 |
| <i>Crossoptilon auritum</i> | Blue-eared pheasant..... | 1 |
| | { Red junglefowl..... | 3 |
| | { Long-tailed fowl..... | 2 |
| <i>Gallus gallus</i> | { Fighting fowl..... | 2 |
| | { Bantam chicken..... | 7 |
| | { Silky bantam..... | 1 |
| | { Silver-spangled Hamburg fowl..... | 1 |
| <i>Gennaeus leucomelanus</i> | Nepal pheasant..... | 3 |
| <i>Hierophasis swinhoei</i> | Swinhoe's pheasant..... | 1 |
| <i>Lophortyx californica valliscola</i> | California valley quail..... | 1 |
| <i>Lophortyx gambelii</i> | Gambel's quail..... | 1 |
| <i>Pavo cristatus</i> | Peafowl..... | 7 |
| <i>Perdix perdix</i> | Hungarian partridge..... | 4 |
| | { Ring-necked pheasant..... | 7 |
| <i>Phasianus colchicus torquatus</i> | { White ring-necked pheasant..... | 2 |
| | { Reeves's pheasant..... | 2 |
| <i>Syrnaticus reevesi</i> | | |
| Numididae: | | |
| <i>Numida meleagris</i> | White guinea fowl..... | 1 |
| Meleagrididae: | | |
| <i>Meleagris gallopavo</i> | Domestic turkey..... | 1 |

GRUIFORMES

| | | |
|--|---------------------------------|---|
| Gruidae: | | |
| <i>Anthropoides virgo</i> | Demoiselle crane..... | 1 |
| <i>Balearica pavonina</i> | West African crowned crane..... | 1 |
| <i>Balearica regulorum gibbericeps</i> | East African crowned crane..... | 1 |

BIRDS—Continued

GRUIFORMES—continued

| <i>Scientific name</i> | <i>Common name</i> | <i>Number</i> |
|---|------------------------------|---------------|
| Gruidae—Continued | | |
| <i>Grus canadensis</i> | Florida sandhill crane..... | 1 |
| <i>Grus leucogeranus</i> | Siberian crane..... | 1 |
| Psophiidae: | | |
| <i>Psophia crepitans</i> | Gray-backed trumpeter..... | 1 |
| Rallidae: | | |
| <i>Fulica americana</i> | American coot..... | 1 |
| <i>Gallinula chloropus cachinnans</i> | Florida gallinule..... | 3 |
| <i>Laterallus leucopyrrhus</i> | Black-and-white crane..... | 1 |
| <i>Porphyrio poliocephalus</i> | South Pacific swamp hen..... | 1 |
| <i>Rallus limicola limicola</i> | Virginia rail..... | 1 |
| Eurypygidiae: | | |
| <i>Eurypyga helias</i> | Sun bittern..... | 2 |
| Cariamidae: | | |
| <i>Cariama cristata</i> | Cariama, or seriama..... | 1 |
| Otididae: | | |
| <i>Chlamydotis undulata macqueeni</i> | MacQueen's bustard..... | 1 |

CHARADRIIFORMES

| | | |
|---|--------------------------------|----|
| Jacanidae: | | |
| <i>Jacana spinosa hypomelaena</i> | Black jaçana..... | 1 |
| Recurvirostridae: | | |
| <i>Himantopus mexicanus</i> | Black-necked stilt..... | 1 |
| Burhinidae: | | |
| <i>Burhinus bistriatus</i> | South American thick-knee..... | 2 |
| Haematopodidae: | | |
| <i>Haematopus ostralegus</i> | Oystercatcher..... | 4 |
| Charadriidae: | | |
| <i>Belonopterus cayennensis</i> | South American lapwing..... | 2 |
| <i>Charadrius vociferus</i> | Killdeer..... | 1 |
| <i>Philomachus pugnax</i> | Ruff..... | 1 |
| Stercorariidae: | | |
| <i>Catharacta macormicki</i> | MacCormick's skua..... | 5 |
| Laridae: | | |
| <i>Larosterna inca</i> | Inca tern..... | 5 |
| <i>Larus atricilla</i> | Laughing gull..... | 1 |
| <i>Larus delawarensis</i> | Ring-billed gull..... | 2 |
| <i>Larus dominicanus</i> | Kelp gull..... | 2 |
| <i>Larus novaehollandiae</i> | Silver gull..... | 12 |

COLUMBIFORMES

| | | |
|---|----------------------------|----|
| Pteroclididae: | | |
| <i>Pterocles orientalis</i> | Sand grouse..... | 1 |
| Columbidae: | | |
| <i>Columba livia</i> | Homing pigeon..... | 8 |
| <i>Columba nigrirostris</i> | Black-billed pigeon..... | 1 |
| <i>Gallinocolumba luzonica</i> | Bleeding-heart dove..... | 5 |
| <i>Geopelia cuneata</i> | Diamond dove..... | 3 |
| <i>Goura victoria</i> | Crowned pigeon..... | 2 |
| <i>Streptopelia decaocto</i> | Ring-necked dove..... | 32 |
| <i>Streptopelia tranquebarica</i> | Blue-headed ring dove..... | 2 |
| <i>Zenaida asiatica</i> | White-winged dove..... | 2 |
| <i>Zenaidura macroura</i> | Mourning dove..... | 5 |

PSITTACIFORMES

| | | |
|------------------------------------|-------------------------------|---|
| Psittacidae: | | |
| <i>Agapornis fischeri</i> | Yellow-collared lovebird..... | 1 |
| <i>Agapornis personata</i> | Masked lovebird..... | 7 |
| <i>Agapornis roseicollis</i> | Rosy-faced lovebird..... | 1 |
| <i>Amazona aestiva</i> | Blue-fronted parrot..... | 1 |
| <i>Amazona auropalliata</i> | Yellow-naped parrot..... | 2 |
| <i>Amazona finschi</i> | Finsch's parrot..... | 3 |

BIRDS—Continued

PSITTACIFORMES—continued

| <i>Scientific name</i> | <i>Common name</i> | <i>Number</i> |
|---|----------------------------------|---------------|
| Psittacidae—Continued | | |
| <i>Amazona leucocephala</i> | Cuban parrot..... | 1 |
| <i>Amazona ochrocephala</i> | Yellow-headed parrot..... | 1 |
| <i>Amazona oratrix</i> | Double yellow-headed parrot..... | 2 |
| <i>Anodorhynchus hyacinthinus</i> | Hyacinthine macaw..... | 1 |
| <i>Ara ararauna</i> | Yellow-and-blue macaw..... | 3 |
| <i>Ara chloroptera</i> | Red-and-blue macaw..... | 3 |
| <i>Ara macao</i> | Red-blue-and-yellow macaw..... | 4 |
| <i>Aratinga canicularis</i> | Petz's parakeet..... | 1 |
| <i>Aratinga pertinax</i> | Rusty-cheeked parrot..... | 4 |
| <i>Brotogeris jugularis</i> | Tovi parakeet..... | 1 |
| <i>Callocephalon fimbriatum</i> | Gang-gang cockatoo..... | 5 |
| <i>Calyptorhynchus magnificus</i> | Banksian cockatoo..... | 2 |
| <i>Domicella garrula</i> | Red lory..... | 1 |
| <i>Eclectus pectoralis</i> | Eclectus parrot..... | 1 |
| <i>Kakatoe alba</i> | White cockatoo..... | 2 |
| <i>Kakatoe ducrops</i> | Solomon Islands cockatoo..... | 1 |
| <i>Kakatoe galerita</i> | Sulphur-crested cockatoo..... | 6 |
| <i>Kakatoe leadbeateri</i> | Leadbeater's cockatoo..... | 10 |
| <i>Kakatoe moluccensis</i> | Great red-crested cockatoo..... | 1 |
| <i>Kakatoe sanguineus</i> | Bare-eyed cockatoo..... | 5 |
| <i>Melopsittacus undulatus</i> | Grass parakeet..... | 45 |
| <i>Nestor notabilis</i> | Kea parrot..... | 3 |
| <i>Nymphicus hollandicus</i> | Cockatiel..... | 4 |
| <i>Pionus menstruus</i> | Blue-headed conure..... | 1 |
| <i>Platyercus elegans</i> | Pennant's parakeet..... | 3 |
| <i>Platyercus eximius</i> | Rosella parakeet..... | 1 |
| <i>Polytelis swainsoni</i> | Barraband's parakeet..... | 2 |
| <i>Psittacula cyanocephala</i> | Plum-headed parakeet..... | 1 |
| <i>Psittacula eupatria</i> | Red-shouldered parakeet..... | 1 |
| <i>Psittacula fasciata</i> | Moustache parakeet..... | 2 |
| <i>Psittacula krameri</i> | Kramer's parakeet..... | 1 |
| <i>Psittacus erithacus</i> | African gray parrot..... | 1 |

CUCULIFORMES

| | | |
|--------------------------------------|---------------------------|---|
| Cuculidae: | | |
| <i>Eudynamys scolopacea</i> | Koel..... | 1 |
| <i>Geococcyx californianus</i> | Roadrunner..... | 2 |
| Musophagidae: | | |
| <i>Crinifer africanus</i> | Plantain-eater..... | 2 |
| <i>Tauraco corythaix</i> | South African turaco..... | 1 |
| <i>Tauraco persa</i> | Purple turaco..... | 1 |

STRIGIFORMES

| | | |
|--------------------------------------|---------------------------------|----|
| Tytonidae: | | |
| <i>Tyto alba pratincola</i> | Barn owl..... | 2 |
| Strigidae: | | |
| <i>Bubo virginianus</i> | Great horned owl..... | 6 |
| <i>Bubo virginianus elutus</i> | Colombian great horned owl..... | 1 |
| <i>Ketupa ketupu</i> | Malay fishing owl..... | 1 |
| <i>Otus asio</i> | Screech owl..... | 1 |
| <i>Strix varia varia</i> | Barred owl..... | 11 |

TROGONIFORMES

| | | |
|---------------------------------|-------------------|---|
| Trogoniidae: | | |
| <i>Priotelus temnurus</i> | Cuban trogon..... | 2 |

BIRDS—Continued

CORACIIFORMES

| <i>Scientific name</i> | <i>Common name</i> | <i>Number</i> |
|--|---------------------------------------|---------------|
| Alcedinidae: | | |
| <i>Dacelo gigas</i> | Kookaburra..... | 5 |
| Bucerotidae: | | |
| <i>Aceros undulatus</i> | Malayan hornbill..... | 1 |
| <i>Anhracoceros malabaricus</i> | Pied hornbill..... | 1 |
| <i>Buceros bicornis</i> | Concave-casqued hornbill..... | 1 |
| <i>Buceros hydrocorax</i> | Philippine hornbill..... | 1 |
| <i>Bucorvus abyssinicus</i> | Abyssinian ground hornbill..... | 1 |
| <i>Bycanistes subcylindricus</i> | Black-and-white casqued hornbill..... | 3 |
| Momotidae: | | |
| <i>Momotus lessoni</i> | Motmot..... | 2 |
| Upupidae: | | |
| <i>Upupa epops</i> | Hoopoe..... | 5 |

PICIFORMES

| | | |
|---|---------------------------------|---|
| Ramphastidae: | | |
| <i>Andigena hypoglauca</i> | Blue toucan..... | 1 |
| <i>Avlacorhampus albivittatus</i> | White-lined toucanet..... | 2 |
| <i>Pteroglossus torquatus</i> | Ringed toucanet..... | 3 |
| <i>Ramphastos carinatus</i> | Sulphur-breasted toucan..... | 2 |
| <i>Ramphastos culminatus</i> | White-breasted toucan..... | 1 |
| <i>Ramphastos swainsoni</i> | Swainson's toucan..... | 1 |
| <i>Ramphastos toco</i> | Toco toucan..... | 3 |
| Capitonidae: | | |
| <i>Cyanops asiatica</i> | Asiatic red-fronted barbet..... | 1 |
| <i>Megalaima zalonica</i> | Streaked barbet..... | 2 |

PASSERIFORMES

| | | |
|--|-----------------------------------|---|
| Cotingidae: | | |
| <i>Chasmorhynchus nudicollis</i> | Bellbird..... | 1 |
| <i>Rupicola rupicola</i> | Orange cock-of-the-rock..... | 2 |
| <i>Rupicola sanguinolenta</i> | Scarlet cock-of-the-rock..... | 1 |
| Tyrannidae: | | |
| <i>Pitangus sulphuratus</i> | Kiskadee flycatcher..... | 4 |
| Alaudidae: | | |
| <i>Alauda arvensis</i> | Skylark..... | 2 |
| Corvidae: | | |
| <i>Calocitta formosa</i> | Magpie jay..... | 1 |
| <i>Corvus brachyrhynchos</i> | Crow..... | 6 |
| <i>Corvus corax principalis</i> | Raven..... | 1 |
| <i>Corvus insolens</i> | Indian crow..... | 2 |
| <i>Cyanocitta cristata</i> | Blue jay..... | 2 |
| <i>Gymnorhina hypoleuca</i> | White-backed piping crow..... | 1 |
| <i>Pica nuttalli</i> | Yellow-billed magpie..... | 1 |
| <i>Pica pica hudsonica</i> | Magpie..... | 4 |
| <i>Urocissa caerulea</i> | Formosan red-billed pie..... | 1 |
| Ptilonorhynchidae: | | |
| <i>Ptilonorhynchus violaceus</i> | Satin bowerbird..... | 2 |
| Timaliidae: | | |
| <i>Garrulax bicolor</i> | White-headed laughing thrush..... | 1 |
| Pycnonotidae: | | |
| <i>Heterophasia capistrata</i> | Black-headed sibia..... | 1 |
| <i>Pycnonotus cafer</i> | Red-vented bulbul..... | 1 |
| <i>Pycnonotus leucogenys</i> | White-cheeked bulbul..... | 1 |
| Mimidae: | | |
| <i>Mimus polyglottos</i> | Mockingbird..... | 1 |

BIRDS—Continued

PASSERIFORMES—continued

| Scientific name | Common name | Number |
|--|------------------------------------|--------|
| Turdidae: | | |
| <i>Geokichla citrina</i> | Orange-headed ground thrush..... | 1 |
| <i>Thamnolaea cinnemomeiventris</i> | Cliff chat..... | 2 |
| <i>Turdus grayi</i> | Bonaparte's thrush..... | 1 |
| <i>Turdus migratorius</i> | { Robin..... | 1 |
| | { Albino robin..... | 1 |
| Sturnidae: | | |
| <i>Acridotheres tristis</i> | Jungle mynah..... | 1 |
| <i>Gracula religiosa</i> | Hill mynah..... | 2 |
| <i>Gracula religiosa indica</i> | Lesser hill mynah..... | 2 |
| <i>Gracula religiosa robusta</i> | Nias wattled mynah..... | 1 |
| <i>Lamprocolius purpureus</i> | Burchell's glossy starling..... | 3 |
| <i>Pastor roseus</i> | Rose-colored pastor..... | 1 |
| <i>Spreo superbus</i> | Tricolored or superb starling..... | 1 |
| <i>Sturnia malabarica</i> | Gray-headed mynah..... | 1 |
| <i>Sturnus vulgaris</i> | Starling..... | 2 |
| Ploceidae: | | |
| <i>Aidemosyne modesta</i> | Plum-headed finch..... | 1 |
| <i>Amadina fasciata</i> | Cut-throat weaver finch..... | 10 |
| <i>Diatropura procne</i> | Giant whydah..... | 5 |
| <i>Estrilda amandava</i> | Strawberry finch..... | 1 |
| <i>Estrilda angolensis</i> | Cordon bleu finch..... | 6 |
| <i>Estrilda astrild</i> | Red-eared waxbill..... | 1 |
| <i>Estrilda cinerea</i> | Common waxbill..... | 4 |
| <i>Estrilda coerulescens</i> | Lavender finch..... | 2 |
| <i>Estrilda melpoda</i> | Orange-cheeked waxbill..... | 1 |
| <i>Estrilda senegala</i> | Fire finch..... | 2 |
| <i>Euplectes afra</i> | Yellow-crowned bishop weaver..... | 10 |
| <i>Euplectes orix</i> | Red bishop weaver..... | 7 |
| <i>Lonchura maja</i> | White-headed nun..... | 16 |
| <i>Lonchura malacca</i> | Black-throated munia..... | 1 |
| <i>Lonchura punctulata</i> | Spice finch..... | 1 |
| <i>Munia oryzivora</i> | Java finch..... | 30 |
| <i>Ploceipasser mahali</i> | Mahali weaver..... | 1 |
| <i>Ploceus baya</i> | Baya weaver..... | 12 |
| <i>Ploceus vitellinus</i> | Vitelline masked weaver..... | 3 |
| <i>Poephila acuticauda</i> | Shaft-tailed finch..... | 2 |
| <i>Poephila gouldiae</i> | { Gouldian finch..... | 3 |
| | { Black-headed Gouldian finch..... | 2 |
| <i>Poephila guttata castanotis</i> | Zebra finch..... | 47 |
| <i>Poephila ruficauda</i> | Star finch..... | 1 |
| <i>Quelea quelea</i> | Red-billed weaver..... | 1 |
| <i>Steganopleura bichenovii</i> | Bichenov's finch..... | 1 |
| <i>Steganura paradisea</i> | Paradise whydah..... | 11 |
| Icteridae: | | |
| <i>Agelaius icterocephalus</i> | Yellow-headed marshbird..... | 1 |
| <i>Icterus giraudi</i> | Giraud's oriole..... | 1 |
| <i>Icterus icterus</i> | Troupial..... | 1 |
| <i>Molothrus bonariensis</i> | Silky cowbird..... | 1 |
| <i>Psomocolax oryzivora</i> | Rice grackle..... | 1 |
| <i>Quiscalus quiscula</i> | Purple grackle..... | 1 |
| <i>Tangavius armenti</i> | Colombian red-eyed cowbird..... | 1 |
| <i>Xanthocephalus xanthocephalus</i> | Yellow-headed blackbird..... | 1 |
| <i>Xanthornus decumanus</i> | Crested oropendola..... | 1 |
| Thraupidae: | | |
| <i>Calospiza ruficapilla</i> | Brown-headed tanager..... | 1 |
| <i>Psomocolax leveriana</i> | Black-and-white tanager..... | 2 |
| <i>Ramphocelus dimidiatus</i> | Crimson tanager..... | 3 |
| <i>Ramphocelus passerini</i> | Passerini's tanager..... | 6 |
| <i>Thraupis cana</i> | Blue tanager..... | 4 |
| <i>Thraupis leucoptera</i> | White-edged tanager..... | 1 |
| <i>Thraupis palmarum</i> | Black-winged palm tanager..... | 2 |

BIRDS—Continued

PASSERIFORMES—continued

| Scientific name | Common name | Number |
|--|----------------------------------|--------|
| Fringillidae: | | |
| <i>Carduelis carduelis</i> | European goldfinch..... | 6 |
| <i>Carduelis carduelis</i> × <i>Serinus canarius</i> | European goldfinch × canary..... | 1 |
| <i>Carpodacus mexicanus frontalis</i> | House finch..... | 1 |
| <i>Melospiza melodia</i> | Song sparrow..... | 1 |
| <i>Paroaria cucullata</i> | Brazilian cardinal..... | 1 |
| <i>Paroaria gularis nigro-genis</i> | Black-eared cardinal..... | 3 |
| <i>Poospiza torquata</i> | Ringed warbling finch..... | 1 |
| <i>Richmondia cardinalis</i> | Cardinal..... | 1 |
| <i>Saltator maximus</i> | Buff-throated saltator..... | 1 |
| <i>Serinus canarius</i> | Canary..... | 3 |
| <i>Sicalis luteola</i> | Saffron finch..... | 6 |
| <i>Sporophila gutturalis</i> | Yellow-billed finch..... | 32 |

REPTILES

LORICATA

| | | |
|---|-----------------------------|----|
| Crocodylidae: | | |
| <i>Alligator mississippiensis</i> | Alligator..... | 19 |
| <i>Alligator sinensis</i> | Chinese alligator..... | 2 |
| <i>Caiman sclerops</i> | Caiman..... | 16 |
| <i>Crocodylus acutus</i> | American crocodile..... | 2 |
| <i>Crocodylus cataphractus</i> | Narrow-nosed crocodile..... | 1 |
| <i>Crocodylus niloticus</i> | African crocodile..... | 1 |
| <i>Crocodylus porosus</i> | Salt-water crocodile..... | 1 |
| <i>Osteolaemus tetraspis</i> | Broad-nosed crocodile..... | 3 |
| <i>Tomistoma schlegeli</i> | Gavial..... | 1 |

SAURIA

| | | |
|--|-------------------------------|----|
| Gekkonidae: | | |
| <i>Gecko smithi</i> | Giant gecko..... | 1 |
| <i>Tarentola mauritanica</i> | Gecko..... | 1 |
| Gerrhosauridae: | | |
| <i>Gerrhosaurus major</i> | Plated lizard..... | 8 |
| Iguanidae: | | |
| <i>Anolis carolinensis</i> | American anolis..... | 35 |
| <i>Anolis cristatellus</i> | Little crested anolis..... | 5 |
| <i>Anolis krugi</i> | Krug's anolis..... | 5 |
| <i>Anolis stratulus</i> | West Indian anolis..... | 4 |
| <i>Cyclura macleani</i> | Cuban iguana..... | 3 |
| <i>Cyclura stejnegeri</i> | Mona Island iguana..... | 1 |
| <i>Iguana iguana</i> | Common iguana..... | 11 |
| <i>Phrynosoma cornutum</i> | Horned toad..... | 10 |
| <i>Sceloporus undulatus</i> | Fence lizard..... | 8 |
| Helodermatidae: | | |
| <i>Heloderma horridum</i> | Mexican beaded lizard..... | 2 |
| <i>Heloderma suspectum</i> | Gila monster..... | 5 |
| Varanidae: | | |
| <i>Varanus varius</i> | Australian lace monitor..... | 2 |
| Teiidae: | | |
| <i>Tupinambis nigropunctatus</i> | Black tegu..... | 1 |
| Scincidae: | | |
| <i>Chalcides sepoides</i> | Three-fingered skink..... | 2 |
| <i>Egernia luctuosa</i> | Mourning skink..... | 2 |
| <i>Egernia whitei</i> | White's skink..... | 8 |
| <i>Eumeces fasciatus</i> | Greater five-lined skink..... | 5 |
| <i>Scincus officinalis</i> | Sand skink..... | 9 |
| <i>Trachysaurus rugosus</i> | Stump-tailed lizard..... | 1 |
| Anguillidae: | | |
| <i>Ophisaurus ventralis</i> | Glass lizard..... | 1 |
| Chamaeleontidae: | | |
| <i>Chamaeleon dilepis</i> | Flap-necked chameleon..... | 1 |
| <i>Chamaeleon jacksoni</i> | Three-horned chameleon..... | 2 |

REPTILES—Continued

SERPENTES

| Scientific name | Common name | Number |
|---|-------------------------------------|--------|
| Boidae: | | |
| <i>Boa enydris cookii</i> | Cook's tree boa..... | 1 |
| <i>Boa enydris enydris</i> | Tree boa..... | 1 |
| <i>Constrictor constrictor</i> | Boa constrictor..... | 2 |
| <i>Constrictor imperator</i> | Emperor boa..... | 2 |
| <i>Epicrates angulifer</i> | Cuban boa..... | 5 |
| <i>Epicrates cenchria</i> | Rainbow boa..... | 5 |
| <i>Eryx thebaicus</i> | Sharp-tailed sand boa..... | 1 |
| <i>Eunectes murinus</i> | Anaconda..... | 5 |
| <i>Python molurus</i> | Indian rock python..... | 1 |
| <i>Python regius</i> | Ball python..... | 5 |
| <i>Python reticulatus</i> | Regal python..... | 3 |
| <i>Python sebae</i> | African python..... | 2 |
| Colubridae: | | |
| <i>Abastor erythrogrammus</i> | Rainbow snake..... | 1 |
| <i>Boaedon lineatum</i> | African house snake, or musaga..... | 2 |
| <i>Coluber constrictor constrictor</i> | Black racer..... | 1 |
| <i>Diadophis punctatus edwardsi</i> | Ring-necked snake..... | 1 |
| <i>Elaphe obsoleta confinis</i> | Southern pilot black snake..... | 1 |
| <i>Elaphe obsoleta guttata</i> | Corn snake..... | 2 |
| <i>Elaphe obsoleta lindheimeri</i> | Lindheimer's rat snake..... | 3 |
| <i>Elaphe obsoleta obsoleta</i> | { Pilot black snake..... | 10 |
| | { Pilot black snake, albino..... | 2 |
| <i>Elaphe quadrivittata</i> | Chicken snake..... | 8 |
| <i>Farancia abacura</i> | Mud snake..... | 2 |
| <i>Heterodon contortrix</i> | Hog-nosed snake..... | 1 |
| <i>Lampropeltis doliata</i> | Scarlet king snake..... | 1 |
| <i>Lampropeltis getulus californiae</i> | California king snake..... | 2 |
| <i>Lampropeltis getulus getulus</i> | King snake..... | 3 |
| <i>Lampropeltis getulus splendida</i> | Sonoran king snake..... | 1 |
| <i>Lampropeltis rhombomaculata</i> | Mole snake..... | 1 |
| <i>Lampropeltis triangulum</i> | Milk snake..... | 2 |
| <i>Leptodiera annulata</i> | Cat-eyed snake..... | 4 |
| <i>Masticophis flagellum flavigularis</i> | Coachwhip snake..... | 6 |
| <i>Natrix erythrogaster</i> | Red-bellied water snake..... | 3 |
| <i>Natrix fasciata</i> | Southern banded water snake..... | 3 |
| <i>Natrix pictiventris</i> | Florida water snake..... | 11 |
| <i>Natrix septemvittata</i> | Queen water snake..... | 2 |
| <i>Natrix sipedon</i> | Water snake..... | 6 |
| <i>Opheodrys vernalis</i> | Smooth-scaled green snake..... | 2 |
| <i>Pituophis sayi</i> | Bull snake..... | 1 |
| <i>Simocephalus capensis</i> | File snake..... | 1 |
| <i>Storeria dekayi</i> | DeKay's snake..... | 2 |
| <i>Storeria o. occipitomaculata</i> | Red-bellied snake..... | 1 |
| <i>Thamnophis sauritus</i> | Ribbon snake..... | 1 |
| <i>Thamnophis sirtalis</i> | Garter snake..... | 3 |
| <i>Zamenis florulentus</i> | Egyptian racer..... | 1 |
| Elapidae: | | |
| <i>Naja haje</i> | Egyptian cobra..... | 9 |
| <i>Naja hannah</i> | King cobra..... | 1 |
| <i>Naja melanoleuca</i> | Black cobra..... | 1 |
| <i>Naja naja</i> | Indian cobra..... | 5 |
| Crotalidae: | | |
| <i>Ancistrodon contortrix mokeson</i> | Northern copperhead snake..... | 7 |
| <i>Ancistrodon piscivorus</i> | Water moccasin..... | 4 |
| <i>Crotalus atrox</i> | Texas diamondback rattlesnake..... | 6 |
| <i>Crotalus horridus</i> | Timber rattlesnake..... | 1 |
| <i>Crotalus lepidus</i> | Rock rattlesnake..... | 1 |
| <i>Sistrurus miliarius</i> | Pygmy rattlesnake..... | 2 |
| <i>Sistrurus miliarius streckeri</i> | Ground rattlesnake..... | 1 |
| <i>Trimeresurus sp</i> | Korean viper..... | 1 |
| <i>Trimeresurus flavoviridis</i> | Habu..... | 1 |

REPTILES—Continued

TESTUDINATA

| <i>Scientific name</i> | <i>Common name</i> | <i>Number</i> |
|--|--------------------------------------|---------------|
| Chelydidae: | | |
| <i>Batrachemys nasuta</i> | South American side-necked turtle. | 2 |
| <i>Chelodina longicollis</i> | Australian side-necked turtle..... | 3 |
| <i>Hydromedusa tectifera</i> | Small side-necked turtle..... | 2 |
| <i>Phrynops geoffroyana</i> | Geoffroy's side-necked turtle..... | 1 |
| <i>Phrynops hilarii</i> | Large side-necked turtle..... | 15 |
| <i>Platemys platycephala</i> | Flat-headed turtle..... | 5 |
| Kinosternidae: | | |
| <i>Kinosternon cruentatum</i> | South American mud turtle..... | 1 |
| <i>Kinosternon subrubrum</i> | Mud turtle..... | 5 |
| <i>Sternotherus odoratus</i> | Musk turtle..... | 6 |
| Chelydridae: | | |
| <i>Chelydra serpentina</i> | Snapping turtle..... | 12 |
| Emydidae: | | |
| <i>Batagur baska</i> | Indian fresh-water turtle..... | 1 |
| <i>Chrysemys picta</i> | Painted turtle..... | 31 |
| <i>Clemmys guttata</i> | Spotted turtle..... | 2 |
| <i>Clemmys insculpta</i> | Wood turtle..... | 8 |
| <i>Clemmys marmorata marmorata</i> | Pacific pond turtle..... | 1 |
| <i>Cyclemys amboinensis</i> | Kura kura box turtle..... | 1 |
| <i>Emydura krefftii</i> | Krefft's turtle..... | 3 |
| <i>Emydura macquariae</i> | Murray turtle..... | 8 |
| <i>Emys orbicularis</i> | European pond turtle..... | 3 |
| <i>Graptemys barbouri</i> | Barbour's turtle..... | 7 |
| <i>Graptemys geographica</i> | Map turtle..... | 3 |
| <i>Graptemys pseudogeographica</i> | False map turtle..... | 4 |
| <i>Kinixys belliana</i> | Hinge-back turtle..... | 1 |
| <i>Malaclemys terrapin</i> | Diamondback turtle..... | 6 |
| <i>Pseudemys decussata</i> | Cuban water turtle..... | 1 |
| <i>Pseudemys elegans</i> | Mobile turtle..... | 12 |
| <i>Pseudemys floridana</i> | Florida water turtle..... | 10 |
| <i>Pseudemys floridana suwannensis</i> | Suwannee turtle..... | 7 |
| <i>Pseudemys ornata</i> | Central American turtle..... | 2 |
| <i>Pseudemys rubriventris</i> | Red-bellied turtle..... | 6 |
| <i>Pseudemys scripta</i> | Red-lined turtle..... | 12 |
| <i>Pseudemys scripta callirostris</i> | South American red-lined turtle..... | 8 |
| <i>Pseudemys scripta troostii</i> | Cumberland turtle..... | 10 |
| <i>Terrapene bauri</i> | Florida box turtle..... | 1 |
| <i>Terrapene carolina</i> | Box turtle..... | 50 |
| <i>Terrapene carolina triunguis</i> | Three-toed box turtle..... | 3 |
| <i>Terrapene ornata ornata</i> | Western box turtle..... | 2 |
| Pelomedusidae: | | |
| <i>Pelomedusa galeata</i> | African water turtle..... | 1 |
| <i>Pelusios nigricans</i> | African black mud turtle..... | 3 |
| <i>Pelusios sinuatus</i> | African snake-neck turtle..... | 8 |
| <i>Phrynops gibba</i> | South American gibba turtle..... | 3 |
| <i>Podocnemis unifilis</i> | Amazon spotted turtle..... | 13 |
| Testudinidae: | | |
| <i>Testudo elephantina</i> | Giant Aldabra turtle..... | 6 |
| <i>Testudo ephippium</i> | Duncan Island turtle..... | 3 |
| <i>Testudo tabulata</i> | South American turtle..... | 2 |
| <i>Testudo vicina</i> | Galápagos turtle..... | 1 |
| Trionychidae: | | |
| <i>Trionyx ferox</i> | American soft-shelled turtle..... | 7 |
| <i>Trionyx triunguis</i> | African soft-shelled turtle..... | 2 |

AMPHIBIANS

CAUDATA

| <i>Scientific name</i> | <i>Common name</i> | <i>Number</i> |
|--------------------------------------|-------------------------|---------------|
| Ambystomidae: | | |
| <i>Ambystoma opacum</i> | Marbled salamander..... | 1 |
| Salamandridae: | | |
| <i>Diemictylus viridescens</i> | Red-spotted newt..... | 28 |
| <i>Taricha torosa</i> | California newt..... | 1 |
| <i>Triturus pyrrhogaster</i> | Red-bellied newt..... | 21 |
| Amphiumidae: | | |
| <i>Amphiuma means</i> | Congo eel..... | 1 |

SALIENTIA

| | | |
|--------------------------------------|-------------------------------|----|
| Dendrobatidae: | | |
| <i>Dendrobates</i> sp..... | Green poison-arrow frog..... | 1 |
| <i>Dendrobates auratus</i> | Black poison-arrow frog..... | 1 |
| <i>Dendrobates typographus</i> | Yellow poison-arrow frog..... | 7 |
| Bufoidae: | | |
| <i>Bufo americanus</i> | American toad..... | 4 |
| <i>Bufo guttatus</i> | Forest toad..... | 2 |
| <i>Bufo marinus</i> | Giant toad..... | 7 |
| <i>Bufo paracnemis</i> | Rococo toad..... | 1 |
| <i>Bufo peltoccephalus</i> | Cuban toad..... | 6 |
| <i>Bufo viridis</i> | European toad..... | 1 |
| Leptodactylidae: | | |
| <i>Ceratophrys calcarata</i> | Colombian horned frog..... | 2 |
| <i>Ceratophrys ornata</i> | Argentine horned frog..... | 1 |
| Hylidae: | | |
| <i>Acris gryllus</i> | Cricket frog..... | 4 |
| <i>Hyla cinerea</i> | Green tree frog..... | 1 |
| <i>Hyla versicolor</i> | Gray tree frog..... | 4 |
| <i>Hylambates maculatus</i> | African flash tree frog..... | 6 |
| <i>Megalixalus fornasinii</i> | African green frog..... | 1 |
| Microhylidae: | | |
| <i>Microhyla carolinensis</i> | Narrow-mouthed toad..... | 2 |
| Pipidae: | | |
| <i>Pipa pipa</i> | Surinam toad..... | 5 |
| Ranidae: | | |
| <i>Rana adspersa</i> | African bull frog..... | 12 |
| <i>Rana catesbeiana</i> | American bull frog..... | 2 |
| <i>Rana clamitans</i> | Green frog..... | 10 |
| <i>Rana pipiens</i> | Leopard frog..... | 25 |

FISHES

| | | |
|--|------------------------------|----|
| <i>Acanthodoras spinosissimus</i> | Talking catfish..... | 1 |
| <i>Acanthophtalmus semicinctus</i> | Large kuhlii..... | 1 |
| <i>Anabas testudineus</i> | Climbing perch..... | 4 |
| <i>Astronotus ocellatus</i> | Peacock cichlid..... | 4 |
| <i>Barbus everetti</i> | Clown barb..... | 2 |
| <i>Betta</i> sp..... | Fightingfish..... | 1 |
| <i>Brachygobius xanthozonus</i> | Bumblebee-fish..... | 1 |
| <i>Corydoras hastatus</i> | Corydoras..... | 6 |
| <i>Distichodus sexfasciatus</i> | | 1 |
| <i>Electrophorus electricus</i> | Electric eel..... | 1 |
| <i>Gambusia punctatus</i> | Blue gambusia..... | 15 |
| <i>Labeo chrysophekadion</i> | Black sharkfish..... | 2 |
| <i>Lebistes reticulatus</i> | { Guppy..... | 25 |
| | { Flag-tailed guppy..... | 10 |
| <i>Lepidosiren paradoxa</i> | South American lungfish..... | 1 |
| <i>Metynnis</i> sp..... | Metynnis..... | 2 |
| <i>Plecostomus plecostomus</i> | Armored catfish..... | 4 |
| <i>Protopterus annectens</i> | African lungfish..... | 1 |
| <i>Pterophyllum eimekii</i> | Black angelfish..... | 2 |
| <i>Serrasalmus niger</i> | Piranha..... | 1 |

FISHES—Continued

| Scientific name | Common name | Number |
|--|--------------------------------|--------|
| <i>Sternarchella schotti</i> | African knifefish..... | 2 |
| <i>Tanichthys albonubes</i> | White Cloud Mountain fish..... | 1 |
| <i>Trichogaster trichopterus</i> | Pearl gourami..... | 1 |
| <i>Xiphophorus helleri</i> | Green swordtail..... | 4 |
| <i>Xiphophorus maculatus</i> | Platys or moonfish..... | 6 |
| Unidentified..... | Mouthbreeders..... | 2 |

ARTHROPODS

| | | |
|------------------------------------|-------------------------------|-----|
| Crustacea: | | |
| <i>Birgus latro</i> | Coconut crab..... | 1 |
| <i>Coenobita clypeatus</i> | Land hermit crab..... | 35 |
| Arachnida: | | |
| <i>Centruroides gracilis</i> | Florida scorpion..... | 2 |
| <i>Eurypelma</i> sp..... | Tarantula..... | 10 |
| <i>Latrodectus mactans</i> | Black-widow spider..... | 1 |
| Insecta: | | |
| <i>Blaberus craniifer</i> | Tropical giant cockroach..... | 100 |

MOLLUSKS

| | | |
|------------------------|------------------|-----|
| <i>Lymnaea</i> sp..... | Pond snails..... | 100 |
|------------------------|------------------|-----|

FINANCES

The appropriation for the National Zoological Park is carried in the District of Columbia Appropriation Act. In the fiscal year 1957, \$720,000 was appropriated, of which \$545,627 was allotted for salaries, leaving \$174,373 for the operation of the Zoo. Included in this last figure is \$65,000 for animal food, \$29,000 for maintenance and repair, and \$15,000 for the purchase of animals. In addition to animals purchased from appropriated funds, many valuable animals are acquired through judicious exchange.

The estimated net worth of the Zoo is approximately \$4,500,000, which includes the value of the land, buildings, improvements, animals, and the current appropriation.

PERSONNEL

J. Lear Grimmer, formerly Assistant Director of the Lincoln Park Zoo, Chicago, Ill., was appointed Assistant Director of the National Zoological Park on June 3. Mr. Grimmer is a trained zoologist, specializing in herpetology but interested in the entire field. He has had eight years experience in zoological park administration.

Former assistant head keeper Ralph Norris, who has had 25 years experience, has been appointed head keeper.

James M. Darrow, an employee since 1931, was promoted from assistant superintendent of maintenance and construction to superintendent.

There are 137 authorized positions at the Zoo, which at the present time are divided as follows: 12 in the administrative office, 52 in the animal department, 21 police, 47 in the mechanical shop, and 5 in the grounds department.

During this fiscal year \$15,310.87 was utilized for terminal leave payments for retiring personnel. Funds are not appropriated for this purpose. In order to absorb this amount it was necessary to maintain vacancies throughout the year. To meet this unique situation all employees had to put forth extra effort. Their loyalty and devotion to the Zoo and their hard work have been reflected in the excellent health of the animals and the general appearance of the Zoo. Great credit is due the employees for their cooperation during this trying time.

Other personnel items referring to retirements are mentioned at the beginning of this report.

INFORMATION AND EDUCATION

The Zoo continues to handle a large correspondence with persons all over the world who write for information regarding animals. From every part of this country citizens write to the Zoo as a national institution. Telephone calls come in constantly, asking for identification of animals, proper diets, or treatment of disease. Visitors to the office as well as to the animal exhibits are constantly seeking information.

The Acting Director spoke before three civic groups and made one television appearance.

The Assistant Director made one television appearance, in which he showed the feeding and handling of gorillas. On another occasion, the Zoo's three baby lion cubs appeared on television.

Two groups of naval medical officers were taken on a tour of the Zoo, special attention being paid to those animals which are reservoirs of human infection, and those with which they might come in contact at their stations.

Malcolm Davis, assistant head keeper, in charge of birds, continues to contribute notes and observations to ornithological journals and publications. He helped revise "Parrots Exclusively" and assisted in the preparation of "Pet Mynas," both published by All-Pets Magazine.

Mario DePrato, principal keeper in charge of the reptile house, talked before a Navy Research group on poisonous reptiles. On a collecting trip in Florida and another in the Dismal Swamp, Va., Mr. DePrato gathered a number of interesting reptiles, which were added to the collection.

Travis Fauntleroy, administrative assistant, and Ralph Norris, head keeper, were sent to the Cincinnati Zoo for two days to study management problems and animal-handling techniques.

While the Zoo does not conduct a regular research program as such, every effort is made to study the animals, and to improve their health, housing, and diet in any way possible.

VETERINARIAN'S REPORT

The work in this department during the past year has been somewhat curtailed in its professional aspects owing to the promotion of the veterinarian to Acting Director upon the retirement of Dr. William M. Mann. The majority of his time has been absorbed in administrative duties which have, regrettably, necessitated leaving undone much of the routine veterinary work.

Several programs that had been started and that require much time and constant attention have been curtailed. Every effort has been made to see that the health of the animals in the Park is safeguarded, and necessary medications and treatment have been given. Particular emphasis has been placed upon the nutritional aspects of veterinary practice and changes in and additions to the diets have been made. This has meant a great deal of extra work on the part of the veterinarian with rather long hours. He has had to be on duty almost every day of the year to fulfill the dual requirements. With the addition of Mr. Grimmer as Assistant Director, the administrative duties have become less arduous. It is expected that after the first part of the next fiscal year a full-time veterinarian will be in residence, so that the programs already started can be continued, and new and better practices put into effect.

Owing to the intense interest among zoo veterinarians and all zoo people in the aspergillosis infection of birds, particularly penguins, there has been instituted a cooperative study with Dr. William Sladen, an English medical biologist, in residence at Johns Hopkins University on a Rockefeller scholarship, and Dr. Carlton Herman of the United States Fish and Wildlife Research Laboratory at Patuxent, Md., on various aspects of aspergillosis. Studies are being undertaken (1) to determine the best method of artificial infection; (2) to find the mode of natural transmission; (3) to develop a sensitivity test or some other method that will lead to an early diagnosis of this disease; (4) to find the most efficacious method of treatment. In connection with this last problem, several new drugs have been tried out by various routes of administration. So far, the work has been promising and many new facts have been learned about the disease although no definite conclusions have as yet been reached.

Following are the statistics for the mortality rates during the past fiscal year and a table of comparison with the last 5 years:

| <i>Mortality, fiscal year 1957</i> | | <i>Total mortality, past 5 fiscal years</i> | |
|--------------------------------------|------------|---|-----|
| Mammals..... | 159 | 1953..... | 672 |
| Birds..... | 165 | 1954..... | 648 |
| Reptiles..... | 176 | 1955..... | 735 |
| Amphibians..... | 25 | 1956..... | 618 |
| Fishes, arachnids, insects, etc..... | 24 | 1957..... | 549 |
| Total..... | 549 | | |

Many of the losses during the year were natural attrition due to senility. During the war years the normal flow of animals was reduced, and since then political situations in many parts of the world and animal disease conditions (necessitating expensive quarantine) have made replacement of stock difficult. It is extremely gratifying to the veterinarian that this year shows a decrease in the number of deaths in comparison with the increase in total animal population and number of species.

COOPERATION

At all times special efforts are made to maintain friendly contacts with other Government and State agencies, private concerns and individuals, and scientific workers for mutual assistance. As a result the Zoo receives much help and advice, and many valuable specimens, and in turn it furnishes information and, whenever possible, specimens it does not need.

Special acknowledgment is due Howard Fyfe, United States Dispatch Agent in New York City. He is frequently called upon to clear shipments of animals coming from abroad, often at great personal inconvenience. The animals have been forwarded to Washington without the loss of a single specimen.

United States Marshal Carlton G. Beall turned over to the Zoo 800 pounds of whole eggs and 18 cases of crabmeat which had been condemned by the court as unfit for human consumption but was fit for animal feed. The poultry division of the Department of Agriculture gave several thousand day-old chicks, which are good food for many young animals. The National Institutes of Health cooperated in many ways, helping with postmortems, giving valuable advice, and donating surplus laboratory animals, some of which were exhibited and some used as food. Laboratory animals that had served their purpose were also donated by the Army Medical Center and the Navy Medical Center.

The Fish and Wildlife Service donated a pair of whistling swans and an eastern weasel, and placed on exhibition in the Zoo two mallard ducks, named MacMallard and Susie, which they intend to use in promotion work for wildlife conservation, much as "Smoky" the bear has been used by the Forestry Service in fire prevention.

In cooperation with Dr. Ray Erickson of the Fish and Wildlife Service, Department of the Interior, Mr. Davis has worked on the development of a brail for Canada geese. The purpose of this project is to develop a brail that will prevent flying but at a later date may be removed and permit the birds to have full use of their



1. Willie and Lucy, white or square-lipped rhinoceros, were captured for the Zoo in Uganda. They are the first of their species to be exhibited in the United States.

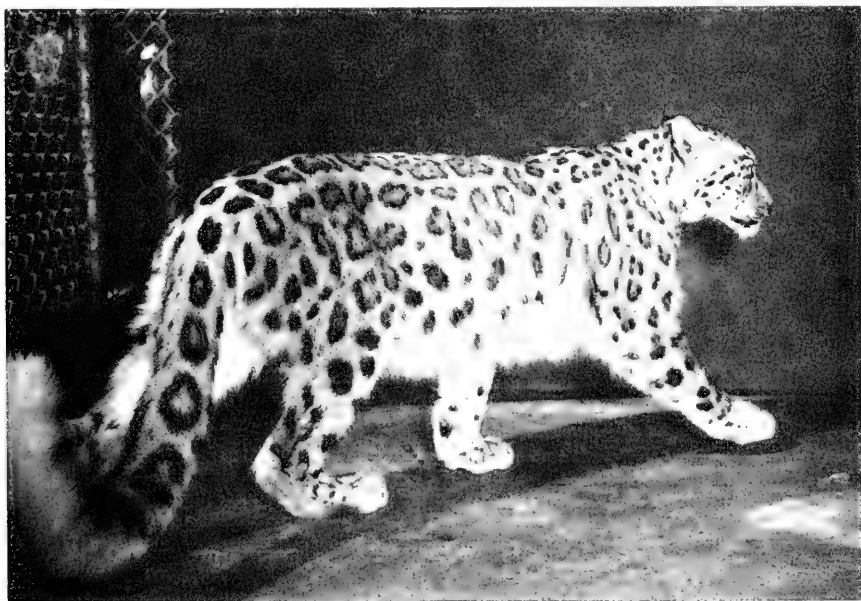

2. The snow leopard, or ounce, inhabits the high altitudes of central Asia. A pair of these beautiful cats was purchased by the Zoo in the late summer of 1956. Photograph by Ernest P. Walker.



Masudi and Hanadi are the first okapis to be exhibited at the National Zoological Park. Gifts of the Belgian Government, they were formally presented on November 28, 1956. Photograph by Rohland, Washington Post and Times-Herald.



Wild-caught hoopoes are too nervous to adapt themselves to captivity. The ones now in the Zoo were taken as nestlings and hand-raised by a collector in Hungary. Photograph by Ernest P. Walker.

wings. It is the desire of the Fish and Wildlife Service to use this brail in establishing flocks of geese in areas that they formerly inhabited, but which they have abandoned owing to hunting pressure and environmental changes.

VISITORS

Attendance at the Zoo this year reached a total of 3,998,546, an all-time high record. In general this figure is based on estimates rather than actual counts.

Estimated number of visitors for fiscal year 1957

| | | | |
|---------------------|----------|---------------|-------------|
| July (1956)----- | 548, 950 | February----- | 206, 850 |
| August----- | 491, 300 | March----- | 315, 900 |
| September----- | 442, 700 | April----- | 403, 346 |
| October----- | 313, 900 | May----- | 468, 200 |
| November----- | 189, 400 | June----- | 389, 300 |
| December----- | 100, 800 | | |
| January (1957)----- | 127, 900 | Total----- | 3, 998, 546 |

Number of groups from schools

| Locality | Number of groups | Number in groups | Locality | Number of groups | Number in groups |
|---------------------------|------------------|------------------|---------------------|------------------|------------------|
| Alabama----- | 21 | 903 | Mississippi----- | 6 | 204 |
| California----- | 1 | 3 | Nebraska----- | 2 | 93 |
| Connecticut----- | 9 | 475 | New Hampshire----- | 1 | 45 |
| Delaware----- | 16 | 730 | New Jersey----- | 20 | 3, 130 |
| District of Columbia----- | 148 | 8, 521 | New York----- | 120 | 6, 154 |
| Florida----- | 14 | 2, 045 | North Carolina----- | 262 | 11, 718 |
| Georgia----- | 55 | 6, 759 | North Dakota----- | 4 | 28 |
| Illinois----- | 7 | 85 | Ohio----- | 52 | 2, 362 |
| Indiana----- | 7 | 491 | Pennsylvania----- | 259 | 14, 644 |
| Iowa----- | 2 | 45 | South Carolina----- | 75 | 2, 589 |
| Kansas----- | 1 | 31 | Tennessee----- | 63 | 2, 622 |
| Kentucky----- | 15 | 667 | Vermont----- | 1 | 35 |
| Louisiana----- | 3 | 125 | Virginia----- | 567 | 38, 266 |
| Maine----- | 17 | 822 | West Virginia----- | 53 | 4, 346 |
| Maryland----- | 549 | 38, 773 | Wisconsin----- | 2 | 167 |
| Massachusetts----- | 17 | 580 | | | |
| Michigan----- | 9 | 496 | Total----- | 2, 388 | 148, 064 |
| Minnesota----- | 8 | 75 | | | |

Other groups, totaling 278 persons, visited the Zoo: two groups from Japan, one from Germany, one from Canada, and three convention groups from the United States.

About 2 p. m. each day the cars then parked in the Zoo are counted and listed according to the State, Territory, or country from which they came. This is, of course, not a census of the cars coming to the Zoo but is valuable in showing the percentage of attendance by States of people in private automobiles. Many District of Columbia, Mary-

land, and Virginia cars come to the Zoo to bring guests from other States. The tabulation for the fiscal year 1957 is as follows:

| | <i>Percent</i> | | <i>Percent</i> |
|---------------------------|----------------|---------------------|----------------|
| Maryland..... | 28.7 | Massachusetts..... | 0.9 |
| Virginia..... | 22.9 | Connecticut..... | .7 |
| District of Columbia..... | 22.1 | Illinois..... | .7 |
| Pennsylvania..... | 4.0 | South Carolina..... | .7 |
| New York..... | 2.7 | Michigan..... | .6 |
| North Carolina..... | 2.2 | California..... | .6 |
| New Jersey..... | 1.6 | Georgia..... | .8 |
| Ohio..... | 1.5 | Tennessee..... | .6 |
| West Virginia..... | 1.3 | Texas..... | .5 |
| Florida..... | 1.1 | | |
| | | | 94.0 |

The remaining 6 percent came from other States, Canada, Alaska, Newfoundland, Okinawa, France, Hawaii, Cuba, Panama, Germany, Mexico, British Columbia, Nova Scotia, England, Guam, South America, Philippine Islands, and Puerto Rico.

On the days of even small attendance there are cars parked in the Zoo from at least 15 States, Territories, the District of Columbia, and foreign countries. On average days there are cars from about 22 States, Territories, the District of Columbia, and foreign countries; and during the periods of greatest attendance the cars represent not less than 34 different States, Territories, and countries.

Parking spaces in the Zoo now accommodate 1,079 cars when the bus parking place is utilized, and 969 cars when it is not used.

GROUNDS, BUILDINGS, AND ENCLOSURES

The National Zoological Park covers an area of 176 acres. There are 3 miles of automobile roads, 3 miles of trails, 7 miles of pedestrian walks, 2 miles of boundary fence, and 8 miles of paddock fence. All told, there are 201 houses: 7 large exhibition buildings; the office; a building that contains police headquarters, public restrooms, and gardener's storeroom; the cafeteria; 19 service buildings, and 172 shelters for animals and equipment. There are 762 animal cages and 16 large outdoor pools.

Also to be considered under maintenance are a central high-pressure heating plant, which includes 1,800 linear feet of conduits, or 3,600 feet of steam lines to the buildings, and six smaller heating plants.

During the year there were extensive replacements, remodeling, and repairs to paddocks, cages, and water lines, with major repairs to the roofs of 12 large animal shelters. A large outdoor pen was remodeled for the African buffalo; the mouflon yard was enlarged by combining two paddocks, and the cage that had formerly housed the

gaur, in the elephant house, was remodeled to make it suitable for the forest-dwelling okapis.

Nine new picnic tables were made in the mechanical shop and set out in various parts of the grounds.

The work of the gardener's force has been mainly that of removing dead trees, which are a menace to both animals and visitors, and replacing them with young trees. The animal department is furnished with forage which is very beneficial for animals. In an exchange with the Park Department of Norfolk, Va., we supplied a few animals for the Zoo there, and received a large shipment of azaleas and camellias, which add greatly to the attractiveness of the Park.

Although the greater part of the Park is kept as natural woodland, there are 22 acres of lawn, which require 128 man-hours to mow, using the present equipment.

The accumulation of trash is still a major problem. After days of heavy attendance, such as Easter Sunday and Monday, 5 to 10 days are required to sweep walks, rake lawns, and make the Park presentable again.

PLANS FOR THE FUTURE

Owing to lack of appropriated funds, no major improvements were undertaken during the fiscal year. The old buildings continue to deteriorate, and even the newest exhibition building is now 20 years old and needs painting and repairs. Ten enclosures, including the pools for exhibition of aquatic mammals, have been abandoned for nearly 10 years. It is hoped that in the near future funds will be appropriated for the following badly needed new construction and improvements:

Buildings.—A building to house antelopes and other hoofed animals that require a heated building. The present structure, built in 1898 for \$3,500 is inadequate, dimly lighted, and poorly ventilated. The rare and beautiful okapis had to be placed here when they arrived last November. The building houses a miscellaneous collection of cats, kangaroos, gaur, the rare agrimi goat, and others. The Zoo has made it a policy not to purchase or accept antelopes, because of the lack of housing for them.

A new administration building to replace the 152-year-old historic landmark, which is still in use as an office building but is not well adapted for the purpose. Termites destroyed the photographic file this year, and most of the Zoo library has now been moved to the second floor of the building to postpone the day when the invaders will attack this valuable collection of scientific books. A thorough examination of the office was made by the District of Columbia Department of Buildings and Grounds, which recommended that unless

extensive repairs are undertaken immediately, the building be condemned as unsafe.

A hospital, which will also serve as a fireproof receiving station for animals shipped in, for quarantining them when necessary and with facilities for caring for those in ill health. This building should also contain an office and laboratory for the veterinarian. There is no structure within the National Zoological Park suitable for conversion into an animal hospital. The building now in use is an ancient stone building, formerly used as a hay barn and storage shed, which was hastily cleaned out and sketchily furnished at the time the veterinarian was appointed in 1955.

Enclosures.—Enclosures and pools for beavers, otters, seals, and nutrias, which cannot be adequately cared for or exhibited under existing conditions.

New paddocks for the exhibition of such animals as deer, sheep, goats, and other hoofed animals, to provide for the exhibition of a greater assortment of these attractive and valuable animals.

Installations.—Extensive remodeling of some of the buildings is needed to bring them up to date with the latest techniques of zoological exhibits, making them more pleasing esthetically for the visitors and ecologically for the animals.

Respectfully submitted.

THEODORE H. REED, *Acting Director.*

DR. LEONARD CARMICHAEL,
Secretary, Smithsonian Institution.

Report on the Canal Zone Biological Area

SIR: It gives me pleasure to present herewith the annual report on the Canal Zone Biological Area for the fiscal year ended June 30, 1957.

SCIENTISTS, STUDENTS, AND OBSERVERS

Anyone with serious interest in tropical wildlife may use the field, laboratory, and living facilities on Barro Colorado Island. These people may stay on the island overnight, or for periods of weeks or months. Some who visit the island carry out technical scientific research, while others come to familiarize themselves with the wildlife and its environment. Most of them are residents of the United States, but some are from the Canal Zone or Europe. Following is a list of the 61 scientists, students, and observers who, during the past year, used the island living facilities and stayed at least one night.

| <i>Name</i> | <i>Principal interest</i> |
|--|---------------------------------|
| Ansley, Dr. and Mrs. H., Johns Hopkins University. | Insect cytology. |
| Banting, Mr. and Mrs. W. L., Amsterdam, Holland. | Wildlife observation. |
| Barbash, Miss B., Swarthmore College. | Wildlife studies. |
| Bartel, Mr. and Mrs. J. N., Pomona, Calif. | Bird observation. |
| Bates, Mr. and Mrs. R. H., Exeter, N. H. | Wildlife observation. |
| Blakely, R. L., Lincoln Park Zoo, Chicago. | Wildlife observation. |
| Burckle, L. H., Army Map Service. | Forest ecology. |
| Burkhart, Mrs. H. H., Sarasota, Fla. | Nature writing. |
| Burroughs, R. P., Board of Directors, Panama Canal. | Wildlife observation. |
| Carson, Dr. and Mrs. H. L., Washington University, St. Louis. | Genetics of <i>Drosophila</i> . |
| Carter, Mr. and Mrs. J. P., Berkeley, Calif. | Wildlife observation. |
| Clark, Dr. W., Eastman Kodak Co. | Photographic tests. |
| Coursen, Mr. and Mrs. B., General Biological Supply House. | Bird observation. |
| Cronin, Mr. and Mrs. W. J., Panama, R. P. | Wildlife observation. |
| Deusing, Murl and Don, Milwaukee Public Museum. | Wildlife photography. |

| <i>Name</i> | <i>Principal interest</i> |
|--|---|
| Eisenmann, Eugene, New York City. | Bird observation. |
| Enders, Dr. R. K., Swarthmore College. | Survey of mammal population. |
| Fast, A. H., Arlington, Va. | Bird observation. |
| Forbes, Dr. and Mrs. A., Milton, Mass. | Wildlife observation. |
| Fouquette, M. J., University of Texas. | Amphibians. |
| Galler, Dr. S. R., Office of Naval Research. | Investigation of laboratory facilities. |
| Graf, J. E., Smithsonian Institution. | Inspection of facilities. |
| Greenewalt, C. H., Wilmington, Del. | High-speed photography of birds. |
| Grégoire, Dr. and Mrs. C., Brussels, Belgium. | Microscopy of insect blood. |
| Groner, Miss D., Los Angeles, Calif. | Bird observation. |
| Hartman, Ziska, Chiriquí, Panama. | Wildlife observation. |
| Heed, Dr. W. B., The Genetics Foundation. | Genetics of <i>Drosophila</i> . |
| Howes, P. G., Bruce Museum, Connecticut. | Wildlife photography. |
| Hughes-Schrader, Dr. S., Columbia University. | Insect cytology. |
| Johnson, Dr. P. T., U. S. Department of Agriculture. | Arthropods. |
| Johnston, H. R., U. S. Forest Service. | Inspection of termite tests. |
| Kellogg, Dr. Remington, Smithsonian Institution. | Inspection of facilities. |
| Kosan, W. M., Margarita, Canal Zone. | Wildlife photography. |
| Lee, Mr. and Mrs. G. E., Balboa, Canal Zone. | Wildlife observation. |
| Marsh, Miss R. E., Margarita, Canal Zone. | Wildlife photography. |
| McHale, J. P., Lincoln Park Zoo, Chicago. | Wildlife observation. |
| McRoberts, Mr. and Mrs. D., Colorado Springs, Colo. | Mammals. |
| Musteric, J. P., Army Map Service. | Forest ecology. |
| Napier, F. C., Frick Park Museum, Pittsburgh. | Wildlife observation. |
| Preston, Dr. and Mrs. F. W., Butler, Pa. | Wildlife observation. |
| Reed, Mr. and Mrs. C. S., Board of Directors, Panama Canal. | Wildlife observation. |
| Rettenmeyer, C. W., University of Kansas. | Army ants. |

| Name | Principal interest |
|--|---|
| Reynolds, Dr. Orr E., Office of Naval Research. | Investigation of laboratory facilities. |
| Schull, Lieut. Gov. and Mrs. H. W., Balboa, Canal Zone. | Wildlife observation. |
| Smith, V. K., U. S. Forest Service. | Inspection of termite tests. |
| Sonneborn, D., Swarthmore College. | Wildlife observation. |
| Soper, Dr. C., Eastman Kodak Tropical Research Laboratory. | Deterioration studies. |
| Stappenbeck, Dr. and Mrs. C., Lake Junaluska, N. C. | Wildlife observation. |
| Stultz, Mrs. O. M., Montebello, Calif. | Bird observation. |
| Sturn, Dr. H., Mainz, Germany. | Plant ecology. |
| Thurman, E. B., National Institutes of Health. | Arthropods. |
| Tryon, Drs. R. M. and A., Missouri Botanical Garden. | Ferns. |
| Usinger, Dr. and Mrs. R. L., University of California. | Insects. |
| Vogel, Dr. S., Mainz, Germany. | Plant ecology. |
| Walch, Miss C., Swarthmore College. | Wildlife observation. |
| Ward, Mr. and Mrs. R., Kennett Square, Pa. | Bird photography. |
| Wasserman, M., The Genetics Foundation. | Genetics of <i>Drosophila</i> . |
| Weatherwax, Dr. and Mrs. P., Indiana University. | Grasses. |
| Weber, Dr. N. A., Swarthmore College. | Fungus-growing ants. |
| Wetmore, Dr. and Mrs. A., Smithsonian Institution. | Bird observation. |
| Wilmar, Mr. and Mrs. H., Walt Disney Productions. | Wildlife photography. |

VISITORS

Visitors for the day were permitted on the island twice a week. Most of these were guided on a walk through the forest by the Resident Naturalist. In all, about 750 visitors, including organized groups of Boy Scouts, Girl Scouts, and military personnel, took advantage of the opportunity to spend a day on the island. This increase of 310 over last year was primarily due to special charges made on an experimental basis to organized groups, particularly Boy and Girl Scouts. The visitors are met in the morning by the launch at Frijoles. Then they are taken to the Island, guided on a 3-hour walk in the forest, provided with lunch, and returned to Frijoles in time for the evening train. In order to aid in accounting for visitors, a system of issuing tickets was introduced.

RAINFALL

During the dry season (January through April) of the calendar year 1956, rains of 0.01 inch or more fell during 55 days (279 hours) and amounted to 12.53 inches, as compared to 10.78 inches during 1955. During the wet season of 1956 (May through December), rains of 0.01 inch or more fell on 215 days (989 hours) and amounted to 101.52 inches, as compared to 103.62 inches during 1955. Total rainfall for the year was 114.05 inches. During 32 years of record the wettest year was 1935, with 143.42 inches, and the driest year was 1930, with only 76.57 inches. February was the driest month of 1956 (2.11 inches) and July the wettest (19.5 inches). The maximum records for short periods were: 5 minutes 1.30 inches; 10 minutes 1.65 inches; 1 hour 4.11 inches; 2 hours 4.81 inches; 24 hours 10.48 inches.

TABLE 1.—Annual rainfall, Barro Colorado Island, C. Z.

| Year | Total inches | Station average | Year | Total inches | Station average |
|------|--------------|-----------------|------|--------------|-----------------|
| 1925 | 104.37 | 113.56 | 1941 | 91.82 | 108.41 |
| 1926 | 118.22 | 114.68 | 1942 | 111.10 | 108.55 |
| 1927 | 116.36 | 111.35 | 1943 | 120.29 | 109.20 |
| 1928 | 101.52 | 106.56 | 1944 | 111.96 | 109.30 |
| 1929 | 87.84 | 101.51 | 1945 | 120.42 | 109.84 |
| 1930 | 76.57 | 123.30 | 1946 | 87.38 | 108.81 |
| 1931 | 123.30 | 113.52 | 1947 | 77.92 | 107.49 |
| 1932 | 113.52 | 105.76 | 1948 | 83.16 | 106.43 |
| 1933 | 101.73 | 107.04 | 1949 | 114.86 | 106.76 |
| 1934 | 122.42 | 110.35 | 1950 | 114.51 | 107.07 |
| 1935 | 143.42 | 108.98 | 1951 | 112.72 | 107.28 |
| 1936 | 93.88 | 110.12 | 1952 | 97.68 | 106.94 |
| 1937 | 124.13 | 110.62 | 1953 | 104.97 | 106.87 |
| 1938 | 117.09 | 110.94 | 1954 | 105.68 | 106.82 |
| 1939 | 115.47 | 109.43 | 1955 | 114.42 | 107.09 |
| 1940 | 86.51 | | 1956 | 114.05 | 107.30 |

TABLE 2.—Comparison of 1955 and 1956 rainfall, Barro Colorado Island (inches)

| Month | Total | | Station average | Years of record | 1956 excess or deficiency | Accumulated excess or deficiency |
|------------|--------|--------|-----------------|-----------------|---------------------------|----------------------------------|
| | 1955 | 1956 | | | | |
| January | 9.05 | 5.57 | 2.19 | 31 | +3.38 | +3.38 |
| February | 0.46 | 2.11 | 1.25 | 31 | +86 | +4.24 |
| March | 0.90 | 2.24 | 1.19 | 31 | +1.05 | +5.29 |
| April | 0.37 | 2.61 | 3.06 | 32 | -0.45 | +4.84 |
| May | 10.58 | 16.55 | 11.01 | 32 | +5.54 | +10.38 |
| June | 13.54 | 6.85 | 11.11 | 32 | -4.26 | +6.12 |
| July | 11.49 | 19.55 | 11.81 | 32 | +7.74 | +13.86 |
| August | 11.36 | 9.48 | 12.18 | 32 | -2.70 | +11.16 |
| September | 9.27 | 11.27 | 9.97 | 32 | +1.30 | +12.46 |
| October | 16.33 | 18.64 | 13.90 | 32 | +4.74 | +17.20 |
| November | 18.35 | 12.37 | 18.81 | 32 | -6.44 | +10.76 |
| December | 12.72 | 6.81 | 10.82 | 32 | -4.01 | +6.75 |
| Year | 114.42 | 114.05 | 107.30 | | | +6.75 |
| Dry season | 10.78 | 12.53 | 7.69 | | | +4.84 |
| Wet season | 103.64 | 101.52 | 99.61 | | | +1.91 |

Evaporation in excess of precipitation is of greater ecological importance than rainfall alone. To measure this quantity a 4-foot-diameter evaporation pan was installed near the laboratory. Water loss in excess of rainfall for the dry season of 1957 was as follows (inches) :

| | |
|----------------|-------------|
| January 3.511 | March 6.629 |
| February 5.344 | April 8.146 |

The dry season was unusually long and rainfall did not exceed evaporation until the last few days of May. For that month the net gain was 0.8 inch.

BUILDINGS, EQUIPMENT, AND IMPROVEMENTS

The major building project of the year was the construction of a 12-by-24-foot above-ground wooden house for use of the workmen living on the island. This house has shower, toilet, and full concrete slab floor at the ground level. The generator house and floor were enlarged, and a third diesel generator was installed in this building. Near Chapman House a new concrete septic tank was built. In order to decrease fire hazard, an isolated gasoline-kerosene storage shed was constructed.

A large part of the work of building a new unloading dock was completed. The project requires bridging of the mouth of Allee Creek, cutting and filling a slope to make a bed for car track and walkway, and extending the unloading dock in front of the generator house. Completion of this work will permit abandonment of the old wooden dock which has been extended again and again because of silting.

Minor construction and maintenance work included building steel and wooden shelves and tables for the darkroom and stockroom in the new laboratory; repairing and painting metal cabinets and shelves which were badly rusted; painting two launches, the aluminum run-about, and several of the old wooden buildings; and replacing all broken screens. All this construction and repair work was done by Mr. Vitola and the regular staff of island laborers.

Among the equipment received on the island was a 14.5-KWA Caterpillar generator. The electric plant now includes three generators, each sufficient for all present electrical needs. Additional electrical apparatus has increased the danger of fire which would cause irreparable loss of the valuable materials on the island. As an added safeguard, 5 CO₂ and 3 water-pump extinguishers were added to the fire-fighting equipment.

Much of the equipment received was for use in the laboratory and in scientific work. This included two window air-conditioners, attic fans, oscillating fans, study lamps, room dehumidifiers, a laboratory refrigerator and freezer, small drying oven, compound and dissecting

microscopes, microscope lamp, binoculars, a spotting telescope, portable typewriter, 4-by-5 Crown Graphic camera, tripod, telephoto lens, exposure meter, photographic enlarger, projection screen, thermograph, hygograph, small and large live-mammal traps, insect nets, and a metal label embosser. Some of this equipment was donated by the General Biological Supply House. Many needed reference books and a subscription to *Ecology* were purchased. To facilitate shoreline exploration, two 12-foot cayucos were acquired.

James Zetek, soon after his retirement, gave to the island most of his extensive biological library. This created the major task of transferring hundreds of books and reprints from the Balboa Office to Barro Colorado Island. With the former island library these publications are now shelved in dehumidified rooms of the new laboratory. One large room of the laboratory is used as a stockroom for supplies which scientists may borrow. Almost the entire present stock of vials, flasks, graduates, and other laboratory glassware, as well as most of the chemicals, was donated by Mr. Zetek. The herbarium, bird skins, and alcoholic collections were also moved to the new laboratory. Now all indoor scientific work may be carried on in this one building, well separated from eating, sleeping, recreational, and other living areas.

The administrative office was moved from Mr. Zetek's house in Balboa to a building in nearby Diablo Heights.

PLANS AND URGENT REQUIREMENTS

Inasmuch as the large wooden water-storage tank near the kitchen may not last even a few more years, the possibility of supplementing stored rainwater with spring water during the dry season has been investigated. A spring was located about 1,000 feet from the concrete water tank at the new laboratory, and 40 feet above the level of this tank. As this spring continued to run throughout the abnormal dry season of early 1957, it should be enclosed and the water piped to the concrete storage tank. It is doubtful, however, that this additional water supply will eliminate the need to replace the wooden water tank. But, with the spring water, a moderate-sized replacement tank may suffice.

The short bridge from the Frijoles dock to the shore must be rebuilt. Materials have been obtained. Most of the ties forming the walkway from this dock to the railroad station need replacement. The trackway from dock to station should be straightened and lengthened, to facilitate the handling of heavy loads. An unloading ramp to aid in carrying gravel, machinery, and other heavy materials from a freight car to the launch is also needed at Frijoles.

Among other projects planned for the coming year on Barro Colorado Island are the following: completion of bridge, trackway, and

unloading area of new dock; overhaul of gasoline winch engine; sheathing the ceiling of the lower floor of the new laboratory, strengthening hallway floor of new laboratory; insulating two rooms of laboratory for efficient air conditioning; construction of clothes-changing rooms at dock level; partitioning the old Zetek office into a separate living apartment and storeroom; construction of drying rooms in the old and new laboratories; addition of dry closets to the Z-M-A and Barbour houses; installation of shower and toilet in Barbour house; installation of shower in Chapman house; rebuilding of dock at Drayton trail-end house; and replacement of termite-eaten timbers of Chapman House.

From the foregoing plans it is apparent that our present labor force of one foreman and two laborers is totally inadequate, considering that these men must also operate the launches, haul supplies, keep the trails clear, guard against poachers, dispose of refuse, and perform other maintenance chores. Ways must be found to augment the labor force with contractual labor, or to increase funds for adding other laborers to our staff. Shortage of labor, especially of skilled type, is the greatest hindrance to proper maintenance and to completion of the construction program.

OTHER ACTIVITIES

The United States Forest Service made final inspection of all termite-resistance tests on the island, with the exception of Drayton trail-end house. Completion of these tests leaves the way clear for the repair or reconstruction of some of the former test houses, if there is demand for their use.

To aid 1-day visitors and naturalists who visit the island, information leaflets were prepared and multilithed for distribution.

More than 1,000 identified plant specimens were mounted on herbarium sheets by women of the Canal Zone College Club, under direction of Mrs. C. B. Koford. These women also bound reprints, sorted publications, and performed other helpful tasks, voluntarily.

To inaugurate population studies on the island many vertebrates were captured, banded or otherwise marked, and released. These animals included more than 100 birds of 31 species, 58 mammals of 11 species, and several reptiles and amphibians. Birds and bats were banded with regulation Fish and Wildlife Service bands.

As part of long-range ecologic studies of forest vegetation, the Naturalist, aided by Joseph Musteric of the Army Map Service, staked out two permanent transects 200 feet in length, plotted the forest profiles, and measured the diameter of the trees. Many more transects should be established, and the vegetation remeasured at intervals of a few years. Many plants, animals, and scenes were photo-

graphed in color for a permanent file of 2-x-2-inch slides. These will be used on the island as orientation and identification aids and as a record of habitat conditions.

The major ornithological event of the year was the discovery in January of a young king vulture (*Sarcoramphus papa*), still largely covered with down, on the forest floor. Heretofore little was known of the nesting and young of this huge spectacular bird. Also of note was the return of the oropendolas (*Zarhynchus wagleri*) to a conspicuous nesting site in the laboratory area. Twenty nests were constructed above the Kodak Test Table Building.

Principally through use of mist nests, the number of species of bats known to occur on Barro Colorado Island was increased from 17 to 28. These bats included two species apparently not previously recorded for Panama (*Centurio senex* and *Micronycteris hirsuta*). Including these, and deleting a few old, unconfirmed, or unnatural reported occurrences, the number of species of mammals known to occur on Barro Colorado Island is 70.

FINANCES

Trust funds for maintenance of the island and its living facilities are obtained by collections from visitors and scientists, by table subscriptions from institutions, and by other donations. The table subscriptions were greatly appreciated as they helped to defray the cost of maintaining the island facilities. Organizations that continued their subscriptions, and the amounts donated, are as follows:

| | |
|----------------------------------|------------|
| Eastman Kodak Co..... | \$1,000.00 |
| New York Zoological Society..... | 300.00 |
| Smithsonian Institution..... | 300.00 |

Donations are also gratefully acknowledged from Blair Coursen, Eugene Eisenmann, C. M. Goethe, Frank Hartman, and F. W. Preston.

ACKNOWLEDGMENTS

The Canal Zone Biological Area can operate only with the excellent cooperation of the Canal Zone Government and the Panama Canal Company. Thanks are due especially to Executive Secretary Paul Runnestrand and his staff, the Customs and Immigration officials, personnel of the Panama Railroad, and the Police Division. The technical advice and assistance provided by P. Alton White, Chief of the Dredging Division, and members of his staff was of invaluable help to the Island.

CARL B. KOFORD, *Resident Naturalist.*

DR. LEONARD CARMICHAEL,
Secretary, Smithsonian Institution.

Report on the International Exchange Service

SIR: I have the honor to submit the following report on the activities of the International Exchange Service for the fiscal year ended June 30, 1957:

The Smithsonian Institution is the official United States agency for the exchange with other nations of governmental, scientific, and literary publications. The International Exchange Service, initiated by the Smithsonian Institution in the early years of its existence for the interchange of scientific publications between learned societies and individuals in the United States and those of foreign countries, serves as a means of developing and executing in part the broad and comprehensive objective, "the diffusion of knowledge." It was later designated by the United States Government as the agency for the transmission of official documents to selected depositories throughout the world, and it continues to execute the exchanges pursuant to conventions, treaties, and other international agreements.

The number of packages of publications received for transmission during the year increased by 43,184 to the yearly total of 1,205,039, and the weight of the packages increased by 24,841 to the yearly total of 827,897 pounds. The average weight of the individual package decreased to 10.99 ounces as compared to the 11.14-ounce average for the fiscal year of 1956.

The publications received from foreign sources for addressees in the United States and from domestic sources for shipment abroad are classified as shown in the following table:

| <i>Classification</i> | <i>Packages</i> | | <i>Weight</i> | |
|--|--------------------|----------------|-----------------|-----------------|
| | <i>Number</i> | <i>Number</i> | <i>Pounds</i> | <i>Pounds</i> |
| United States parliamentary documents sent abroad..... | 686, 446 | | 231, 661 | |
| Publications received in return for parliamentary documents..... | | 8, 264 | | 14, 644 |
| United States departmental documents sent abroad..... | 279, 520 | | 283, 024 | |
| Publications received in return for departmental documents..... | | 6, 377 | | 19, 035 |
| Miscellaneous scientific and literary publications sent abroad..... | 164, 541 | | 177, 552 | |
| Miscellaneous scientific and literary publications received from abroad for distribution in the United States..... | | 59, 891 | | 101, 981 |
| Total..... | 1, 130, 507 | 74, 532 | 692, 237 | 135, 660 |
| Grand total..... | 1, 205, 039 | | 827, 897 | |

The packages of publications are forwarded to the exchange bureaus of foreign countries by freight or, where shipment by such means is impractical, to the foreign addressees by direct mail. Distribution in the United States of the publications received through the foreign exchange bureaus is accomplished primarily by mail, but by other means when more economical. The number of boxes shipped to the foreign exchange bureaus was 3,132, or 58 more than for the previous year. Of these boxes 911 were for depositories of full sets of United States Government documents, these publications being furnished in exchange for the official publications of foreign governments which are received for deposit in the Library of Congress. The number of packages forwarded by mail and by means other than freight was 208,503.

There was allocated to the International Exchange Service for transportation \$40,900. With this amount it was possible to effect the shipment of 859,071 pounds, which was 21,883 pounds more than was shipped in the previous year. However, approximately 10,540 pounds of the full sets of United States Government documents accumulated during the year because the Library of Congress had requested suspension of shipment to certain foreign depositories.

During the year ocean freight rates per cubic foot increased from the June 30, 1956, average of \$1.28 to \$1.464. However, about a fourth of the cost of this increase will be offset by a reduction on June 13, 1957, of approximately 17 percent in the truck rates to the Baltimore piers.

The total outgoing correspondence comprised 2,406 letters, exclusive of information copies.

With the exception of those to Taiwan, no shipments are being made to China, North Korea, Outer Mongolia, Communist-controlled area of Viet-Nam, or Communist-controlled area of Laos.

Shipping arrangements were completed with the newly established Rumanian International Exchange Service and the first postwar shipment was made to Rumania on November 29.

With certain exceptions the regulations of the Bureau of Foreign Commerce, Department of Commerce, provide that each package of publications exported bear a general license symbol and the legend, "Export License Not Required." The International Exchange Service accepts for transmission to foreign destinations only those packages of publications that fall within the exception and those packages of publications to which the general license symbol and legend have been applied by the consignor.

FOREIGN DEPOSITORIES OF GOVERNMENTAL DOCUMENTS

The number of sets of United States official publications received by the Exchange Service for transmission abroad in return for the

official publications sent by foreign governments for deposit in the Library of Congress is now 105 (62 full and 43 partial sets), listed below. Changes that occurred during the year are shown in the footnotes.

DEPOSITORIES OF FULL SETS

- ARGENTINA:** División Biblioteca, Ministerio de Relaciones Exteriores y Culto, Buenos Aires.
- AUSTRALIA:** Commonwealth Parliament and National Library, Canberra.
NEW SOUTH WALES: Public Library of New South Wales, Sydney.
QUEENSLAND: Parliamentary Library, Brisbane.
SOUTH AUSTRALIA: Public Library of South Australia, Adelaide.
TASMANIA: Parliamentary Library, Hobart.
VICTORIA: Public Library of Victoria, Melbourne.
WESTERN AUSTRALIA: Public Library of Western Australia, Perth.
- AUSTRIA:** Administrative Library, Federal Chancellery, Vienna.
- BELGIUM:** Bibliothèque Royale, Bruxelles.
- BRAZIL:** Biblioteca Nacional, Rio de Janeiro.
- BULGARIA:** Bulgarian Bibliographical Institute, Sofia.¹
- BURMA:** Government Book Depot, Rangoon.
- CANADA:** Library of Parliament, Ottawa.
MANITOBA: Provincial Library, Winnipeg.
ONTARIO: Legislative Library, Toronto.
QUEBEC: Library of the Legislature of the Province of Quebec.
- CEYLON:** Department of Information, Government of Ceylon, Colombo.
- CHILE:** Biblioteca Nacional, Santiago.
- CHINA:** National Central Library, Taipei, Taiwan.
 National Chengchi University, Taipei, Taiwan.
- COLOMBIA:** Biblioteca Nacional, Bogotá.
- COSTA RICA:** Biblioteca Nacional, San José.
- CUBA:** Ministerio de Estado, Canje Internacional, Habana.
- CZECHOSLOVAKIA:** National and University Library, Prague.
- DENMARK:** Institut Danois des Échanges Internationaux, Copenhagen.
- EGYPT:** Bureau des Publications, Ministère des Finances, Cairo.
- FINLAND:** Parliamentary Library, Helsinki.
- FRANCE:** Bibliothèque Nationale, Paris.
- GERMANY:** Deutsche Staatsbibliothek, Berlin.
 Free University of Berlin, Berlin.
 Parliamentary Library, Bonn.
- GREAT BRITAIN:**
ENGLAND: British Museum, London.
LONDON: London School of Economics and Political Science. (Depository of the London County Council.)
- HUNGARY:** Library of Parliament, Budapest.¹
- INDIA:** National Library, Calcutta.
 Central Secretariat Library, New Delhi.
- INDONESIA:** Ministry for Foreign Affairs, Djakarta.
- IRELAND:** National Library of Ireland, Dublin.
- ISRAEL:** State Archives and Library, Hakirya, Jerusalem.²
- ITALY:** Ministero della Pubblica Istruzione, Rome.
- JAPAN:** National Diet Library, Tokyo.³

¹ Shipment suspended.

² Changed from Government Archives and Library, Hakirya, Tel Aviv.

³ Receives two sets.

- MEXICO:** Secretaría de Relaciones Exteriores, Departamento de Información para el Extranjero, México, D. F.
- NETHERLANDS:** Royal Library, The Hague.
- NEW ZEALAND:** General Assembly Library, Wellington.
- NORWAY:** Utenriksdepartementets Bibliothek, Oslo.
- PERU:** Sección de Propaganda y Publicaciones, Ministerio de Relaciones Exteriores, Lima.
- PHILIPPINES:** Bureau of Public Libraries, Department of Education, Manila.
- POLAND:** Bibliothèquc Nationale, Warsaw.¹
- PORTUGAL:** Biblioteca Nacional, Lisbon.
- SPAIN:** Biblioteca Nacional, Madrid.
- SWEDEN:** Kungliga Biblioteket, Stockholm.
- SWITZERLAND:** Bibliothèquc Centrale Fédérale, Berne.
- TURKEY:** Department of Printing and Engraving, Ministry of Education, Istanbul.
- UNION OF SOUTH AFRICA:** State Library, Pretoria, Transvaal.
- UNION OF SOVIET SOCIALIST REPUBLICS:** All-Union Lenin Library, Moscow.
- UNITED NATIONS:** Library of the United Nations, Geneva, Switzerland.
- URUGUAY:** Oficina de Canje Internacional de Publicaciones, Montevideo.
- VENEZUELA:** Biblioteca Nacional, Caracas.
- YUGOSLAVIA:** Bibliografski Institut, Belgrade.²

DEPOSITORIES OF PARTIAL SETS

- AFGHANISTAN:** Library of the Afghan Academy, Kabul.
- ANGLO-EGYPTIAN SUDAN:** Gordon Memorial College, Khartoum.
- BOLIVIA:** Biblioteca del Ministerio de Relaciones Exteriores y Culto, La Paz.
- BRAZIL:**
MINAS GERAIS: Directoria Geral de Estatistica em Minas, Belo Horizonte.
- BRITISH GUIANA:** Government Secretary's Office, Georgetown, Demerara.
- CANADA:**
ALBERTA: Provincial Library, Edmonton.
BRITISH COLUMBIA: Provincial Library, Victoria.
NEW BRUNSWICK: Legislative Library, Fredericton.
NEWFOUNDLAND: Department of Provincial Affairs, St. John's.
NOVA SCOTIA: Provincial Secretary of Nova Scotia, Halifax.
SASKATCHEWAN: Legislative Library, Regina.
- DOMINICAN REPUBLIC:** Biblioteca de la Universidad de Santo Domingo, Ciudad Trujillo.
- ECUADOR:** Biblioteca Nacional, Quito.
- EL SALVADOR:**
 Biblioteca Nacional, San Salvador.
 Ministerio de Relaciones Exteriores, San Salvador.
- GREECE:** National Library, Athens.
- GUATEMALA:** Biblioteca Nacional, Guatemala.
- HAITI:** Bibliothèquc Nationale, Port-au-Prince.
- HONDURAS:**
 Biblioteca y Archivo Nacionales, Tegucigalpa.
 Ministerio de Relaciones Exteriores, Tegucigalpa.
- ICELAND:** National Library, Reykjavik.
- INDIA:**
BOMBAY: Secretary to the Government, Bombay.
BIHAR: Revenue Department, Patna.

INDIA—Continued

UTTAR PRADESH:

University of Allahabad, Allahabad.

Secretariat Library, Uttar Pradesh, Lucknow.

WEST BENGAL: Library, West Bengal Legislative Secretariat, Assembly House, Calcutta.

IRAN: Imperial Ministry of Education, Tehran.

IRAQ: Public Library, Baghdad.

JAMAICA:

Colonial Secretary, Kingston.

University College of the West Indies, St. Andrew.

LEBANON: American University of Beirut, Beirut.

LIBERIA: Department of State, Monrovia.

MALAYA: Federal Secretariat, Federation of Malaya, Kuala Lumpur.

MALTA: Minister for the Treasury, Valleta.

NICARAGUA: Ministerio de Relaciones Exteriores, Managua.

PAKISTAN: Central Secretariat Library, Karachi.

PANAMA: Ministerio de Relaciones Exteriores, Panamá.

PARAGUAY: Ministerio de Relaciones Exteriores, Sección Biblioteca, Asunción.

PHILIPPINES: House of Representatives, Manila.⁴

SCOTLAND: National Library of Scotland, Edinburgh.

SIAM: National Library, Bangkok.

SINGAPORE: Chief Secretary, Government Offices, Singapore.

VATICAN CITY: Biblioteca Apostolica Vaticana, Vatican City.

INTERPARLIAMENTARY EXCHANGE OF THE OFFICIAL JOURNAL

There are now being sent abroad 77 copies of the Federal Register and 89 copies of the Congressional Record. This is an increase over the preceding year of 1 copy of the Federal Register and 1 copy of the Congressional Record. The countries to which these journals are being forwarded are given in the following list:

DEPOSITORIES OF CONGRESSIONAL RECORD AND FEDERAL REGISTER

ARGENTINA:

Biblioteca del Poder Judicial, Mendoza.⁵

Boletín Oficial de la República Argentina, Ministerio de Justicia e Instrucción Pública, Buenos Aires.

Cámara de Diputados Oficina de Información Parlamentaria, Buenos Aires.

AUSTRALIA:

Commonwealth Parliament and National Library, Canberra.

NEW SOUTH WALES: Library of Parliament of New South Wales, Sydney.

QUEENSLAND: Chief Secretary's Office, Brisbane.

VICTORIA: Public Library of Victoria, Melbourne.⁵

WESTERN AUSTRALIA: Library of Parliament of Western Australia, Perth.

BRAZIL: Secretaria de Presidencia, Rio de Janeiro.⁶

BRITISH HONDURAS: Colonial Secretary, Belize.

⁴ Added during the year.

⁵ Federal Register only.

⁶ Congressional Record only.

CANADA :

Library of Parliament, Ottawa.
 Clerk of the Senate, Houses of Parliament, Ottawa.

CEYLON : Ceylon Ministry of Defense and External Affairs, Colombo.⁶

CHINA :

Legislative Yuan, Taipei, Taiwan.⁶
 Taiwan Provincial Government, Taipei, Taiwan.

CUBA :

Biblioteca del Capitolio, Habana.
 Biblioteca Pública Panamericana, Habana.⁶

CZECHOSLOVAKIA : Ceskoslovenska Akademie Ved, Prague.^{4 6}

EGYPT : Ministry of Foreign Affairs, Egyptian Government, Cairo.⁶

FRANCE :

Bibliothèque Assemblée Nationale, Paris.
 Bibliothèque Conseil de la République, Paris.
 Library, Organization for European Economic Cooperation, Paris.⁶
 Research Department, Council of Europe, Strasbourg.⁶
 Service de la Documentation Étrangère, Assemblée Nationale, Paris.⁶

GERMANY :

Amerika-Institut der Universität München, München.⁶
 Archiv, Deutscher Bundesrat, Bonn.
 Bibliothek der Instituts für Weltwirtschaft an der Universität Kiel, Kiel-Wik.
 Bibliothek Hessischer Landtag, Wiesbaden.⁶
 Der Bayrische Landtag, Munich.^{6 7}
 Deutschen Institut für Rechtswissenschaft, Potsdam-Babelsberg II.^{4 6}
 Deutscher Bundesrat, Bonn.⁶
 Deutscher Bundestag, Bonn.⁶
 Hamburgisches Welt-Wirtschafts-Archiv, Hamburg.

GHANA : Chief Secretary's Office, Accra.⁶

GREAT BRITAIN :

Department of Printed Books, British Museum, London.
 House of Commons Library, London.⁶
 Printed Library of the Foreign Office, London.
 Royal Institute of International Affairs, London.⁶

GREECE : Bibliothèque, Chambre des Députés Hellénique, Athens.

GUATEMALA : Biblioteca de la Asamblea Legislativa, Guatemala.

HAITI : Bibliothèque Nationale, Port-au-Prince.

HONDURAS ; Biblioteca del Congreso Nacional, Tegucigalpa.

HUNGARY : National Library, Budapest.

INDIA :

Civil Secretariat Library, Lucknow, United Provinces.⁶
 Indian Council of World Affairs, New Delhi.⁶
 Jammu and Kashmir Constituent Assembly, Srinagar.⁶
 Legislative Assembly, Government of Assam, Shillong.⁶
 Legislative Assembly Library, Lucknow, United Provinces.
 Legislative Assembly Library, Trivandrum.⁶
 Madras State Legislature, Madras.⁶
 Parliament Library, New Delhi.
 Servants of India Society, Poona.⁶

⁷ Three copies.

IRELAND : Dail Eireann, Dublin.

ISRAEL : Library of the Knesset, Jerusalem.

ITALY :

Biblioteca Camera dei Deputati, Rome.

Biblioteca del Senato della Republica, Rome.

European Office, Food and Agriculture Organization of the United Nations, Rome.⁵

International Institute for the Unification of Private Law, Rome.⁵

JAPAN :

Library of the National Diet, Tokyo.

Ministry of Finance, Tokyo.

JORDAN : Parliament of the Hashemite Kingdom of Jordan, Amman.⁶

KOREA : Secretary General, National Assembly, Pusan.

LUXEMBOURG : Assemblée Commune de la C. E. C. A., Luxembourg.

MEXICO :

Dirección General Information, Secretaría de Gobernación, México, D. F.

Biblioteca Benjamin Franklin, México, D. F.

AGUASCALIENTES : Gobernador del Estado de Aguascalientes, Aguascalientes.

BAJA CALIFORNIA : Gobernador del Distrito Norte, Mexicali.

CAMPECHE : Gobernador del Estado de Campeche, Campeche.

CHIAPAS : Gobernador del Estado de Chiapas, Tuxtla Guitierrez.

CHIHUAHUA : Gobernador del Estado de Chihuahua, Chihuahua.

COAHUILA : Periódico Oficial del Estado de Coahuila, Palacio de Gobierno, Saltillo.

COLIMA : Gobernador del Estado de Colima, Colima.

GUANAJUATO : Secretaría General de Gobierno del Estado, Guanajuato.⁵

JALISCO : Biblioteca del Estado, Guadalajara.

MÉXICO : Gaceta del Gobierno, Toluca.

MICHOACÁN : Secretaría General de Gobierno del Estado de Michoacán, Morelia.

MORELOS : Palacio de Gobierno, Cuernavaca.

NAYARIT : Gobernador de Nayarit, Tepic.

NUEVO LEÓN : Biblioteca del Estado, Monterrey.

OAXACA : Periódico Oficial, Palacio de Gobierno, Oaxaca.⁵

PUEBLA : Secretaría General de Gobierno, Puebla.

QUERÉTARO : Secretaría General de Gobierno, Sección de Archivo, Querétaro.

SINALOA : Gobernador del Estado de Sinaloa, Culiacán.

SONORA : Gobernador del Estado de Sonora, Hermosillo.

TAMAULIPAS : Secretaría General de Gobierno, Victoria.

VERACRUZ : Gobernador del Estado de Veracruz, Departamento de Gobernación y Justicia, Jalapa.

YUCATÁN : Gobernador del Estado de Yucatán, Mérida.

NETHERLANDS : Koninklijke Bibliotheek, The Hague.⁵

NEW ZEALAND : General Assembly Library, Wellington.

NORWAY : Library of the Norwegian Parliament, Oslo.

PANAMA : Biblioteca Nacional, Panama City.⁵

POLAND : Kancelaria Rady, Panstwa, Biblioteka Sejmowa, Warsaw.⁴

PORTUGUESE TIMOR : Repartição Central de Administração Civil, Dili.⁵

SWITZERLAND: Bibliothèque, Bureau International du Travail, Geneva.⁵
International Labor Office, Geneva.^{5*}
Library, United Nations, Geneva.

UNION OF SOUTH AFRICA:

CAPE OF GOOD HOPE: Library of Parliament, Cape Town.

TRANSVAAL: State Library, Pretoria.

UNION OF SOVIET SOCIALIST REPUBLICS: Fundamental'nii Biblioteka Obschestvennykh Nauk, Moscow.

URUGUAY: Diario Oficial, Florida 1178, Montevideo.

FOREIGN EXCHANGE SERVICES

Exchange publications for addresses in the countries listed below are forwarded by freight to the exchange services of those countries. Exchange publications for addresses in other countries are forwarded directly by mail.

LIST OF EXCHANGE SERVICES

AUSTRIA: Austrian National Library, Vienna.

BELGIUM: Services des Échanges Internationaux, Bibliothèque Royale de Belgique, Bruxelles.

CHINA: National Central Library, Taipei, Taiwan.

CZECHOSLOVAKIA: Bureau of International Exchanges, University Library, Prague.

DENMARK: Institut Danois des Échanges Internationaux, Bibliothèque Royale, Copenhagen.

EGYPT: Government Press, Publications Office, Bulaq, Cairo.

FINLAND: Delegation of the Scientific Societies, Helsinki.

FRANCE: Service des Échanges Internationaux, Bibliothèque Nationale, Paris.

GERMANY (Eastern): Deutsche Staatsbibliothek, Berlin.

GERMANY (Western): Notgemeinschaft der Deutschen Wissenschaft, Bad Godesberg.

HUNGARY: National Library, Széchényi, Budapest.

INDIA: Government Printing and Stationery, Bombay.

INDONESIA: Minister of Education, Djakarta.

ISRAEL: Jewish National and University Library, Jerusalem.

ITALY: Ufficio degli Scambi Internazionali, Ministero della Pubblica Istruzione, Rome.

JAPAN: Division of International Affairs, National Diet Library, Tokyo.

NETHERLANDS: International Exchange Bureau of the Netherlands, Royal Library, The Hague.

NEW SOUTH WALES: Public Library of New South Wales, Sydney.

NEW ZEALAND: General Assembly Library, Wellington.

NORWAY: Service Norvégien des Échanges Internationaux, Bibliothèque de l'Université Royale, Oslo.

PHILIPPINES: Bureau of Public Libraries, Department of Education, Manila.

POLAND: Service Polonais des Échanges Internationaux, Bibliothèque Nationale, Warsaw.

PORTUGAL: Secção de Trocas Internacionais, Biblioteca Nacional, Lisbon.

QUEENSLAND: Bureau of International Exchange of Publications, Chief Secretary's Office, Brisbane.

* Two copies.

RUMANIA: International Exchange Service, Biblioteca Centrala de Stat, Bucharest.

SOUTH AUSTRALIA: South Australian Government Exchanges Bureau, Government Printing and Stationery Office, Adelaide.

SPAIN: Junta de Intercambio y Adquisición de Libros y Revistas para Bibliotecas Públicas, Ministerio de Educación Nacional, Madrid.

SWEDEN: Kungliga Biblioteket, Stockholm.

SWITZERLAND: Service Suisse des Échanges Internationaux, Bibliothèque Centrale Fédérale, Palais Fédéral, Berne.

TASMANIA: Secretary of the Premier, Hobart.

TURKEY: National Library, Ankara.⁹

UNION OF SOUTH AFRICA: Government Printing and Stationery Office, Cape Town.

UNION OF SOVIET SOCIALIST REPUBLICS: Bureau of Book Exchange, State Lenin Library, Moscow.

VICTORIA: Public Library of Victoria, Melbourne.

WESTERN AUSTRALIA: State Library of Western Australia, Perth.¹⁰

YUGOSLAVIA: Bibliografski Institut FNRJ, Belgrade.

Respectfully submitted.

D. G. WILLIAMS, *Chief.*

Dr. LEONARD CARMICHAEL,
Secretary, Smithsonian Institution.

⁹ Changed from Ministry of Education, Istanbul.

¹⁰ Changed from Public Library of Western Australia, Perth.

Report on the National Gallery of Art

SIR: I have the honor to submit, on behalf of the Board of Trustees, the 20th annual report of the National Gallery of Art for the fiscal year ended June 30, 1957. This report is made pursuant to the provisions of section 5 (d) of Public Resolution No. 14, 75th Congress, first session, approved March 24, 1937 (50 Stat. 51).

ORGANIZATION

The statutory members of the Board of Trustees of the National Gallery of Art are the Chief Justice of the United States, the Secretary of State, the Secretary of the Treasury, and the Secretary of the Smithsonian Institution, ex officio. On May 1, 1957, Chester Dale was reelected a general trustee of the National Gallery of Art to serve in that capacity for the term expiring July 1, 1967. Mr. Dale was also reelected by the Board of Trustees on May 2, 1957, to serve as President of the Gallery, and Ferdinand Lamot Belin was reelected Vice President. The four other general trustees continuing in office during the fiscal year ended June 30, 1957, were Ferdinand Lamot Belin, Duncan Phillips, Paul Mellon, and Rush H. Kress.

On September 13, 1956, the Trustees of the Gallery elected Perry B. Cott as Chief Curator and Mrs. Fern R. Shapley as Assistant Chief Curator. At this same meeting the Trustees approved the appointments of William P. Campbell as Curator of Paintings and John E. Pancoast as Registrar.

The executive officers of the Gallery as of June 30, 1957, are as follows:

Huntington Cairns, Secretary-Treasurer.
John Walker, Director.
Ernest R. Feidler, Administrator.

Huntington Cairns, General Counsel.
Perry B. Cott, Chief Curator.
Macgill James, Assistant Director.

On July 1, 1957, Macgill James retired as Assistant Director of the Gallery.

The three standing committees of the Board, as constituted at the annual meeting on May 2, 1957, are as follows:

EXECUTIVE COMMITTEE

Chief Justice of the United States,
Earl Warren, Chairman.
Chester Dale, Vice Chairman.
Ferdinand Lamot Belin.

Secretary of the Smithsonian Institution, Dr. Leonard Carmichael.
Paul Mellon.

FINANCE COMMITTEE

Secretary of the Treasury,
George M. Humphrey, Chairman.
Chester Dale, Vice Chairman.

Secretary of the Smithsonian Institution, Dr. Leonard Carmichael.
Ferdinand Lammot Belin.
Paul Mellon.

ACQUISITIONS COMMITTEE

Ferdinand Lammot Belin, Chairman.
Duncan Phillips.
Chester Dale.

Paul Mellon.
John Walker.

PERSONNEL

On June 30, 1957, full-time Government employees on the staff of the National Gallery of Art numbered 313 as compared with 312 as of June 30, 1956. The United States Civil Service regulations govern the appointment of employees paid from appropriated public funds.

APPROPRIATIONS

For the fiscal year ended June 30, 1957, the Congress of the United States in the regular annual appropriation for the National Gallery of Art provided \$1,505,000 to be used for salaries and expenses in the operation and upkeep of the Gallery, the protection and care of works of art acquired by the Board of Trustees, and all administrative expenses incident thereto, as authorized by Joint Resolution of Congress approved March 24, 1937 (20 U. S. C. 71-75; 50 Stat. 51). Congress also included in a supplemental appropriation act \$30,000 to cover (a) the additional cost of steam for heating and air-conditioning the Gallery, which cost exceeded the original estimate of General Services Administration by \$18,000; (b) the increased cost of electric current (\$3,800), and (c) the increase of salaries of employees whose rates of pay were adjusted as of December 2, 1956, by Wage Board determination under authority of Public Law 763, 83d Congress (\$8,200). The total appropriation for the fiscal year was \$1,535,000. The following expenditures and encumbrances were incurred:

| | |
|--|-------------------|
| Personal services (including \$413,088.28 for guard protection)----- | \$1, 293, 635. 00 |
| Other than personal services----- | 241, 336. 07 |
| Unobligated balance----- | 28. 93 |
| | <hr/> |
| Total----- | 1, 535, 000. 00 |

ATTENDANCE

There were 942,196 visitors to the Gallery during the fiscal year 1957 as compared to an attendance of 1,013,246 for the fiscal year 1956. The average daily number of visitors was 2,596.

ACCESSIONS

There were 650 accessions by the National Gallery of Art as gifts, loans, or deposits during the fiscal year.

GIFTS

During the year, the following gifts or bequests were accepted by the Board of Trustees:

| PAINTINGS | | |
|-------------------------------|-----------------------|--|
| <i>Donor</i> | <i>Artist</i> | <i>Title</i> |
| William Robertson Coe..... | Renoir..... | Girl with a Basket of Fish. |
| William Robertson Coe..... | Renoir..... | Girl with a Basket of Oranges. |
| Lewis Einstein..... | Fragonard..... | Adoration d'un trone. |
| Lewis Einstein..... | School of Antwerp.. | Goosen van Bonhuysen. |
| Lewis Einstein..... | Greco-Egyptian.... | Portrait of a Woman. |
| Howard Sturges..... | Gainsborough..... | Shepherd Boys and Dog Sheltering from Storm. |
| Howard Sturges..... | Guardi..... | Castel Sant' Angelo. |
| Howard Sturges..... | Shee..... | The Earl of Beverley. |
| Howard Sturges..... | Shee..... | The Countess of Beverley. |
| Howard Sturges..... | Hoppner..... | Portrait of a Man. |
| Miss Edith Reynolds..... | Henri..... | Edith Reynolds. |
| Horace Havemeyer..... | Manet..... | Gare Saint-Lazare. |
| Col. and Mrs. E. W. Garbisch. | Buddington..... | Father and Son. |
| Col. and Mrs. E. W. Garbisch. | Chambers..... | The Connecticut River Valley. |
| Col. and Mrs. E. W. Garbisch. | Field..... | Ark of the Covenant. |
| Col. and Mrs. E. W. Garbisch. | Hashagen..... | Ship Arkansas Leaving Havana. |
| Col. and Mrs. E. W. Garbisch. | MacKay..... | Catherine Brower. |
| Col. and Mrs. E. W. Garbisch. | Ropes..... | Mount Vernon. |
| Col. and Mrs. E. W. Garbisch. | Unknown..... | Boy and Girl. |
| Col. and Mrs. E. W. Garbisch. | Unknown..... | Brothers. |
| Col. and Mrs. E. W. Garbisch. | Unknown..... | Miss Daggett. |
| Col. and Mrs. E. W. Garbisch. | Unknown..... | Landscape with Group of Buildings. |
| Col. and Mrs. E. W. Garbisch. | Unknown..... | Woman Taking Footbath. |
| Col. and Mrs. E. W. Garbisch. | Unknown..... | Washington, the Mason. |
| Col. and Mrs. E. W. Garbisch. | Unknown..... | "We Go for the Union." |
| Col. and Mrs. E. W. Garbisch. | Vanderlyn, attr. to.. | Miss Van Alen. |

PAINTINGS—Continued

| <i>Donor</i> | <i>Artist</i> | <i>Title</i> |
|-----------------------------|---------------|--------------------------------------|
| Alexander D. Thayer..... | Harding..... | Charles Carroll of Carrollton. |
| William Nelson Cromwell.. | Goya..... | Victor Guye. |
| George Matthew Adams... | Legros..... | Memory Copy of Holbein's Erasmus. |
| Katharine Husson Horstick.. | Eakins..... | Louis Husson. |
| Katharine Husson Horstick.. | Eakins..... | Mrs. Louis Husson. |
| Albert M. Friend, Jr..... | Neagle..... | George Dodd. |
| Albert M. Friend, Jr..... | Neagle..... | Julia Anne Dodd. |
| Avalon Foundation..... | Harnett..... | My Gems. |
| Curt H. Reisinger..... | Zorn..... | Hugo Reisinger. |
| Curt H. Reisinger..... | Besnard..... | Nude. |
| Curt H. Reisinger..... | Melchers..... | The Sisters. |

SCULPTURE

| | | |
|-------------------------|-------------|------------------|
| George Matthew Adams... | Dalou..... | Alphonse Legros. |
| Miss Syma Busiel..... | Houdon..... | Diana. |

PRINTS AND DRAWINGS

| | | |
|------------------------------|----------------|-------------------------|
| Mellon Collection..... | Bellows..... | 15 lithographs. |
| Mrs. Andrew Carey..... | Various..... | 17 prints and drawings. |
| Herbert and Claiborne Pell.. | Various..... | 8 prints. |
| Mrs. Roger H. Plowden.... | Hazeltine..... | 2 watercolors. |
| Howard Sturges..... | Various..... | 10 drawings. |
| George Matthew Adams... | Legros..... | 24 prints and drawings. |
| William Robertson Coe.... | Various..... | 1 print, 17 books. |
| Lewis Einstein..... | Various..... | 3 drawings. |

WORKS OF ART ON LOAN

The following works of art were received on loan by the Gallery:

| <i>From:</i> | <i>Artist</i> |
|---|---------------|
| The Putnam Foundation, San Diego, Calif.: | |
| View of Volterra..... | Corot. |
| Virgin and Child with St. Elizabeth, the Infant St. John and St. Justine. | Veronese. |
| Christ on the Cross..... | Murillo. |
| Chester Dale, New York, N. Y.: | |
| Portrait of a Little Girl..... | Eigleton (?). |
| Col. and Mrs. Edgar W. Garbisch, New York, N. Y.: | |
| Eighty-two early American paintings. | |
| Peter Jay, Havre de Grace, Md.: | |
| John Jay..... | Stuart. |
| Robert Woods Bliss, Washington, D. C.: | |
| Twenty-two objects of Pre-Columbian art. | |
| Mrs. Eugene Meyer, Washington, D. C.: | |
| Vase of Flowers..... | Cezanne. |
| Portrait of a Sailor..... | Cezanne. |
| Le Chateau Noir..... | Cezanne. |
| Still Life..... | Cezanne. |
| Still Life..... | Dufresne. |
| Still Life..... | Manet. |
| Nude..... | Renoir. |
| Portrait of a Man..... | Renoir. |

WORKS OF ART ON LOAN RETURNED

The following works of art on loan were returned during the fiscal year:

| <i>To:</i> | <i>Artist</i> |
|---|---------------|
| Samuel H. Kress Foundation, New York, N. Y. : | |
| 75 paintings and 2 sculptures. | |
| Mr. and Mrs. C. B. Wrightsman, Palm Beach, Fla. : | |
| Portrait of a Young Girl..... | Vermeer. |
| Claiborne Pell, Washington, D. C. : | |
| The Jolly Flatboatmen..... | Bingham. |
| Mrs. Eugene Meyer, Washington, D. C. : | |
| Vase of Flowers..... | Cezanne. |
| Portrait of a Sailor..... | Cezanne. |
| Le Chateau Noir..... | Cezanne. |
| Still Life..... | Cezanne. |
| Still Life..... | Dufresne. |
| Still Life..... | Manet. |
| Nude..... | Renoir. |
| Portrait of a Man..... | Renoir. |
| Chester Dale, New York, N. Y. : | |
| Head of a Woman..... | Derain. |
| Woman in an Armchair..... | Derain. |
| Woman in a Chemise..... | Derain. |
| The Bathers..... | Tondu. |
| Indian Maiden..... | Wright. |
| Robert Woods Bliss, Washington, D. C. : | |
| Six objects of Pre-Columbian art. | |

WORKS OF ART LENT

During the fiscal year the Gallery lent the following works of art for exhibition purposes:

| <i>To:</i> | <i>Artist</i> |
|--|---------------|
| American Embassy, Paris : | |
| Mary Barry..... | Stuart. |
| Ann Barry..... | Stuart. |
| Two drawings of Classic Ruins..... | Guardi. |
| Blair-Lee House, Washington, D. C. : | |
| General Marshal..... | Stephens. |
| Secretary Forrestal..... | Murray. |
| Corcoran Gallery of Art, Washington, D. C. : | |
| Mending the Harness..... | Ryder. |
| Dallas Museum of Fine Arts, Dallas, Tex. : | |
| Andrew Jackson..... | Earl. |
| Franklin Pierce..... | Healy. |
| William Henry Harrison..... | Lambdin. |
| The Washington Family (engraving)..... | Savage. |
| John Quincy Adams..... | Sully. |
| Andrew Jackson..... | Sully. |
| General Dwight Eisenhower..... | Stephens. |
| George Washington..... | Stuart. |
| Alexander Hamilton Bicentennial Commission, Washington, D. C. : | |
| Alexander Hamilton..... | Trumbull. |

| <i>To:</i> | <i>Artist</i> |
|--|-----------------|
| Toledo Museum of Art, Toledo, Ohio : | |
| Mending the Harness----- | Ryder. |
| Virginia 350th Anniversary, Jamestown Festival, Williams- burg, Va. : | |
| Pocahontas ----- | British School. |
| Wadsworth Atheneum, Hartford, Conn. : | |
| William Rogers----- | Trumbull. |
| Detroit Institute of Arts, Detroit, Mich. : | |
| Siegfried and the Rhine Maidens----- | Ryder. |
| Columbus Gallery of Fine Arts, Columbus, Ohio : | |
| Chester Dale----- | Bellows. |
| Connecticut Historical Society, Hartford, Conn. : | |
| Miss Daggett ----- | Artist unknown. |
| Institute of Contemporary Arts, Washington, D. C. : | |
| Six prints ----- | Canaletto. |
| Four prints----- | Piranesi. |
| Smithsonian Institution Traveling Exhibition Service, Wash- ington, D. C. : | |
| Forty-five modern German prints. | |

EXHIBITIONS

The following exhibitions were held at the National Gallery of Art during the fiscal year 1957 :

- Masterpieces of Graphic Art from the Rosenwald Collection. Reopened May 23, 1956, continuing through July 8, 1956.
- American Paintings from the Collection of the National Gallery of Art. July 13, 1956, through August 12, 1956.
- Prints by the French Impressionists. From the Rosenwald Collection. August 15, 1956, through December 31, 1956.
- A Retrospective Exhibition of the Work of George Bellows. The first one-man show in the history of the National Gallery of Art. January 19, 1957, through February 24, 1957.
- American Primitive Paintings. From the Collection of Edgar William and Berince Chrysler Garbisch (2d exhibition). March 16, 1957, through April 28, 1957.
- "One Hundred Years of Architecture in America." An exhibition celebrating the Centennial of the American Institute of Architects. May 15, 1957, through July 14, 1957.

TRAVELING EXHIBITIONS

Rosenwald Collection.—Special exhibitions of prints from the Rosenwald Collection were circulated to the following places during the fiscal year 1957 :

- Rijks Museum, Amsterdam, Holland :
- Three Rembrandt drawings----- May–October 1956.
- Minneapolis Institute of Arts, Minneapolis,
Minn. :
- Exhibition, "Prints, 1400–1800," three
 prints----- October–November 1956.

- Philadelphia Art Alliance, Philadelphia, Pa. :
 Twenty-nine Rowlandson prints----- October–November 1956.
- Marion Koogler McNay Art Institute, San Antonio, Tex. :
 Twenty-two Rembrandt etchings----- November–December 1956.
- North Carolina Museum of Art, Raleigh, N. C. :
 Exhibition, "Rembrandt and School," 54 prints----- November–December 1956.
- The Baltimore Museum of Art, Baltimore, Md. :
 Exhibition, "4,000 Years of Modern Art," one print----- November 1956–June 1957.
- The Museum of Fine Arts, Houston, Tex. :
 Exhibition, "The Life of Christ," 68 prints----- December 1956–January 1957.
- Art Institute of Chicago, Ill. :
 Exhibition, "Prints, 1400–1800," three prints----- January 1957.
- The University Gallery, University of Minnesota :
 Exhibition, "Musical Exhibition," 33 prints----- January–February 1957.
- Fort Worth Art Center, Fort Worth, Tex. :
 Exhibition, "Horse and Rider," eight prints----- January–March 1957.
- Literature and Fine Arts Gallery, Michigan State University :
 Exhibition, "Impressionist Prints," 30 prints----- February–March 1957.
- Museum of Modern Art, New York, N. Y. :
 Exhibition, "Munch," one print----- February–March 1957.
- Smithsonian Institution Traveling Exhibition Service, Washington, D. C. :
 Exhibition, "Bellows," 19 prints----- March- 1957.
- Grolier Club, New York, N. Y. :
 Exhibition, "Blake," four prints----- April–June 1957.
- Community Arts Program, Munson-Williams-Proctor Institute, Utica, N. Y. :
 Exhibition, "Portraiture: The 19th and 20th Centuries," six prints----- April–December 1957.

Index of American Design.—During the fiscal year 1957, 23 traveling exhibitions (including 804 plates) with 50 bookings were circulated to the following States and Germany :

| State | Number of exhibitions | State | Number of exhibitions |
|----------------------------|-----------------------|----------------------|-----------------------|
| Alabama ----- | 2 | Minnesota ----- | 1 |
| Arkansas ----- | 4 | Missouri ----- | 2 |
| Connecticut ----- | 3 | New Mexico ----- | 1 |
| District of Columbia ----- | 2 | New York ----- | 2 |
| Florida ----- | 1 | North Carolina ----- | 3 |
| Illinois ----- | 1 | Oklahoma ----- | 1 |
| Kentucky ----- | 2 | South Carolina ----- | 3 |
| Maine ----- | 2 | Tennessee ----- | 2 |
| Maryland ----- | 1 | Virginia ----- | 13 |
| Michigan ----- | 3 | Germany ----- | 1 |

CURATORIAL ACTIVITIES

The Curatorial Department accessioned 131 gifts to the Gallery during the fiscal year 1957. Advice was given with respect to 346 works of art brought to the Gallery for expert opinion, and 10 visits to collections were made by members of the staff in connection with offers of gift or for expert opinion. About 1,520 inquiries requiring research were answered verbally and by letter.

William Campbell gave three lectures on American primitive painting at the Cooperstown summer seminars and also spoke to a women's group at Shepherdstown, W. Va. He assisted in the judging of an exhibition of the art work of State Department employees. John Pancoast judged an art contest for AMVETS. Erwin O. Christensen lectured on African Negro sculpture at Howard University, gave a Washington Seminar lecture on the Index of American Design, and held 12 monthly talks for USIA groups on the Index. Miss Elizabeth Mongan lectured at the Detroit Institute of Art, served on a jury for an exhibition in Philadelphia, and spoke to 10 groups visiting Alverthorpe Gallery. Miss Elizabeth Benson spoke to two women's organization meetings. Hereward Lester Cooke assisted in the judging of seven art exhibitions in the Washington area.

Perry B. Cott served as a member of the Board of Governors of the Archaeological Institute of America, Washington Society. Miss Katherine Shepard was secretary of this organization and went as official delegate to its General Meeting in Philadelphia. Miss Mongan was Honorary Vice President of the American Color Print Society, served on the American Jury of Selection of the International Graphic Arts Society and was a director and member of the Executive Committee of the Print Council of America.

RESTORATION

Francis Sullivan, Resident Restorer of the Gallery, made regular and systematic inspection of all works of art at the Gallery, and periodically removed dust and bloom as required. He relined 6 paintings, and gave special treatment to 34 paintings. Nineteen paintings were X-rayed as an aid in research. Experiments were continued with the application of 27H and other synthetic varnishes developed by the National Gallery of Art Fellowship at the Mellon Institute of Industrial Research, Pittsburgh, Pa. Proofs of all color reproductions of Gallery paintings were checked and approved, and technical advice on the conservation of paintings was furnished to the public upon request.

Mr. Sullivan inspected all Gallery paintings on loan in Government buildings in Washington. He also gave advice on and special

treatment to works of art belonging to other Government agencies including the White House, the Freer Gallery of Art, and the Smithsonian Institution.

PUBLICATIONS

The Director's book on *The Feast of the Gods* and related paintings, entitled "Bellini and Titian at Ferrara," appeared during the year. Mrs. Fern R. Shapley was the coauthor of a book "Comparisons in Art," also published by the Phaidon Press. She also prepared the text for the Gallery's Portfolio No. 5, "Masterpieces from the Samuel H. Kress Collection." Mr. Campbell compiled the data for the Bellows and Garbisch exhibition catalogs, and wrote the introduction to the Garbisch catalog. Mr. Christensen prepared a guide to the Chinese porcelains of the Widener Collection, and wrote an article on "An American Primitive Portrait Group" for *Antiques* magazine. Mr. Cooke's research on "Documents Relating to the Fontana di Trevi" was published in the September *Art Bulletin*, and six of his short articles for the *Ladies Home Journal* appeared during the year. Mr. Pancoast reviewed a book on Ghiberti for *The American Scholar*.

During the past fiscal year the Publications Fund published three new 11-x-14-inch color reproductions, and two more were on order. Eleven new color post cards were published; and plates were made for seven new Christmas and Easter folders. Two more large collotype reproductions of paintings on exhibition, distributed by a New York publisher, were placed on sale; 11-x-14-inch reproductions printed on canvas, an entirely new type of item, were also on order.

Two new books of A. W. Mellon Lectures in the Fine Arts, "The Art of Sculpture," by Herbert Read, and "The Nude," by Kenneth Clark, were placed on sale. "American Primitive Paintings," Part II, was made available, and a book "Portrait of Jesus," by Marian King, based on pictures in the National Gallery of Art, was stocked, as well as a paper-bound edition of a booklet, "Favorite Paintings from the National Gallery of Art," by present and former members of the Gallery staff. There was a fourth printing issued of the Gallery's Handbook No. 1, "How to Look at Works of Art; The Search for Line," by Lois A. Bingham.

Catalogs of the George Bellows show and "One Hundred Years of Architecture in America" exhibition were distributed.

A boxed set of ten 2-x-2-inch color slides with text was made available.

EDUCATIONAL PROGRAM

The program of the Educational Office was carried out under the supervision of the Curator in Charge of Educational Work and his staff who lectured and conducted guided tours in the National Gallery of Art on the works of art in its collection.

The attendance for the general tours, Congressional tours, "Tours for the Week," and "Pictures of the Week," totaled 43,954 while that for the 51 auditorium lectures on Sunday afternoons was approximately 11,488 during the fiscal year 1957.

Tours, lectures, and conferences were arranged by special appointment for 322 groups and individuals. The total number of people served in this manner was 7,640. This is an increase over last year of 23 groups and 350 persons. These special appointments were made for such groups as representatives from high schools, universities, museums, governmental agencies, and distinguished visitors.

The program of training volunteer docents was continued during the fiscal year. Fifty-seven ladies were given special instruction under the general supervision of the Curator in Charge of Educational Work and under the specific direction of one of the members of the staff. By arrangement with the school systems of the District of Columbia and surrounding counties of Virginia and Maryland, these ladies assisted in giving guided tours for the children from these schools. In all, 751 classes, with a total of 22,561 children, were given the tours during the fiscal year. This represents an increase over last year of 4,046 children in attendance.

The staff of the Educational Office delivered 20 lectures in the auditorium on Sunday afternoons. Twenty-four lectures were given by guest speakers, and during April and May Dr. Sigfried Giedion delivered the Sixth Annual Series of seven A. W. Mellon Lectures in the Fine Arts on the theme "Constancy and Change in Art and Architecture."

During the past year 205 persons borrowed a total of 6,110 slides from the slide lending collection.

The office completed in May two new slide strip films on paintings in the National Gallery of Art which will be available for sale about July 1, 1957. These are in addition to two other slide strips (one on sculpture, and one on prints) and one strip film, which have been available.

The centers throughout the country that distribute the National Gallery of Art film, "Your National Gallery," report approximately 72,339 persons viewed the film in 310 showings.

Members of the staff prepared leaflets on the works of art in individual galleries; prepared mimeographed material for school tours and to accompany slide loans; and prepared and recorded 33 radio broadcasts for use during intermission periods of the National Gallery concerts.

The printed Calendar of Events announcing all the Gallery's activities was prepared by the Educational Office and distributed monthly to a mailing list of approximately 4,500 names.

LIBRARY

The most important acquisitions to the Library this year were 2,137 books, pamphlets, periodicals, subscriptions, and photographs purchased from private funds, and 53 books, pamphlets, and subscriptions to periodicals purchased from Government funds made available for this purpose. Gifts included 849 books and pamphlets; while 713 books, pamphlets, periodicals, and bulletins were received in exchange from other institutions. More than 420 persons other than Gallery staff spent time in the Library for study or research, and approximately 1,500 telephone reference requests were handled.

The Library is the depository for photographs of works of art in the collections of the National Gallery of Art. A stock of reproductions is maintained for use in research occupations by the curatorial staff and other departments of the Gallery, for the dissemination of knowledge to qualified sources; for exchange with other institutions; for reproduction in scholarly works; and for sale at the request of interested individuals. Approximately 5,000 photographs were added to the Library's stock; 585 mail orders, and 500 direct sales were handled; and 300 permits to reproduce 680 subjects were processed in the Library.

INDEX OF AMERICAN DESIGN

The work of the Index continued as in previous years. The Curator in charge of the Index continued to take part in the orientation program for United States Information Agency personnel with thirteen 50-minute illustrated talks on the background and purpose of the Index and on the folk arts and crafts in the United States.

A new project of printed guide leaflets on the material in the Index was started, as well as a project of 20 color-slide sets which were placed on sale.

The Index cooperated with the USIA in making these slide sets available to their overseas personnel. Approximately 704 persons studied the Index material for purposes of research or exhibition, to gather material for publication and design, and to become familiar with the Index.

Twenty groups of color slides (801 in all) were lent in eight States and India. Three exhibitions of Index material were held in the National Gallery of Art, and 23 traveling exhibitions were circulated.

MAINTENANCE OF THE BUILDING AND GROUNDS

The Gallery building, its mechanical equipment, and its grounds have been maintained at the established standard throughout the year; emphasis, however, has been given to reducing the water leaks which are common to skylight roofs.



Manet: Gare Saint-Lazare. Gift of Horace Havemeyer to the National Gallery of Art in memory of his mother Louise W. Havemeyer, 1956.



1. Goya y Lucientes: Victor Goye. Gift of William Nelson Cromwell to the National Gallery of Art.



2. Houdon: Diana. Gift of Syma Busiel to the National Gallery of Art.

With funds made available by the A. W. Mellon Educational and Charitable Trust, the air-conditioning system has been extended to cover first-aid rooms, other areas on the ground floor, art storage rooms, and shops.

With funds made available by Congress a contract has been let for changing the elevator in the west wing of the Gallery building from operator controlled to passenger operated.

A contract has been let for an experimental electronic installation of a 10-minute tape-recorded Gallery broadcast providing a lecture, receivable on an earphone device, pertaining to the works of art in several gallery rooms. It is proposed to rent the earphone receiving devices at a small fee to persons wishing to hear the lectures in the wired gallery rooms.

OTHER ACTIVITIES

Forty Sunday evening concerts were given during the fiscal year in the East Garden Court. The National Gallery Orchestra, conducted by Richard Bales, played 10 concerts at the Gallery. Two of these concerts were made possible by the Music Performance Trust Fund of the American Federation of Musicians. The first eight concerts of the series were given in commemoration of the Mozart Bicentennial. A string orchestra under Mr. Bales' direction played during the opening of the Bellows Exhibition on January 19, 1957, and during the Garbisch Exhibition opening on March 15, 1957. The Orchestra was engaged to play a concert at Constitution Hall on February 3 with Mr. Bales conducting. In September 1956 Mr. Bales' cantata "The Union" (premiere at the National Gallery of Art June 10, 1956), was recorded at the Gallery by Columbia Records. The National Gallery Orchestra and soloists played for the recording. During May 1957, the four Sunday evening concerts were devoted to the Gallery's Fourteenth American Music Festival. All concerts were broadcast in their entirety by Station WGMS AM and FM, Washington.

The American Institute of Architects commissioned Mr. Bales to compose an orchestral work as part of its Centennial Celebration. This composition, "National Gallery Suite No. 3," was premiered on May 26, 1957. The intermissions during the Sunday evening concerts featured discussions by members of the Educational Office staff and Mr. Bales.

During the fiscal year 2,056 copies of nine press releases were issued in connection with Gallery activities. One hundred and fifty permits to copy and 208 permits to photograph in the Gallery were also issued.

The Photographic Laboratory of the Gallery produced 12,967 prints, 242 black-and-white slides, 814 color slides, 1,974 black-and-

white negatives, 52 color-separation negatives, and 126 color transparencies, 8 infrareds, 5 ultraviolets, 10 X-rays, and 5 film positives.

OTHER GIFTS

Gifts of money were made during the fiscal year 1957 by the Old Dominion Foundation, Avalon Foundation, Corning Museum of Glass, J. Hopkins Smith, Jr., and Donald F. Hyde.

AUDIT OF PRIVATE FUNDS OF THE GALLERY

An audit of the private funds of the Gallery will be made for the fiscal year ended June 30, 1957, by Price Waterhouse & Co., public accountants, and the certificate of that company on its examination of the accounting records maintained for such funds will be forwarded to the Gallery.

Respectfully submitted.

HUNTINGTON CAIRNS, *Secretary.*

Dr. LEONARD CARMICHAEL,
Secretary, Smithsonian Institution.

Report on the Library

SIR: I have the honor to submit the following report on the activities of the Smithsonian library for the fiscal year ended June 30, 1957:

The 54,316 publications received during the year included purchases and gifts, but the larger number of them came, as usual, from scientific, technical, and cultural institutions and societies all over the world, in exchange for publications of the Smithsonian Institution. These exchange publications, foreign and domestic, especially the files of scientific serials, form the backbone of the library's collections and are the principal primary sources of information upon which the library's services to the Institution are based. There were 87 new exchanges arranged this year.

Many friends of the Institution gave books and papers to the library. Among the 7,972 publications so received were L. L. Buchanan's gift of 475 books and many bulletins, pamphlets, and separates from his own private scientific library; Frank Morton Jones's gift of 39 volumes on Psychidae; and Mrs. George P. Merrill's gift of 100 volumes from the library of her late husband, formerly head curator of geology. Harold J. Coolidge most generously turned over to the library some 400 handsome publications of the Institut des Parcs Nationaux du Congo Belge, with the privilege of selecting anything needed to fill gaps in our own sets, the remainder to be sent to a designated library on the west coast.

From among the much larger number of recommended titles, funds permitted the purchase of only 621 books and subscriptions for 475 periodicals not obtainable in exchange. These were the reference books and journals most urgently needed for the common use of all, and the most important of the primary sources of information in special subject areas of the Institution's researches and curatorial responsibilities. The list of desiderata of books, new and old, that it would be useful and time-saving for the curators and other specialists to have immediately at hand continues to grow. The expanding program of work and the many new projects being initiated in the Institution find many subjects inadequately covered by the literature in the library, and there are serious gaps in the working collections that ought to be filled. Unfortunately, the prices of books and periodicals continue to rise, and a good many institutions and societies that formerly sent their journals freely in exchange, or gratis, now find

it financially necessary to charge for them in order to assure continuity of publication.

There were 22,359 publications sent to the Library of Congress, 5,086 of which were books and periodicals to be added to the Smithsonian Deposit. The others, not individually recorded in the library, were documents, doctoral dissertations, and miscellaneous publications of no immediate interest to the Institution. The library transferred 1,474 publications, mostly medical dissertations, to the National Library of Medicine.

The year's record of cataloging included a total of 4,044 volumes cataloged, 26,184 cards filed, and 23,173 periodicals entered. The catalog section had full responsibility for the much-expanded bindery program which was continued for the second year, and 11,900 volumes of periodicals and books, new and old, were prepared and sent to be bound or rebound. Again, through a waiver from the Government Printing Office, the work was done by a commercial binder, under contract. The very considerable reduction in the long-standing arrearage of binding during the past 2 years has saved from progressive deterioration and possible loss many thousands of hitherto unbound numbers of important scientific journals, and has greatly increased the ease of use of the journals. By no means to be minimized is the improved appearance that fresh, newly bound volumes give to the library shelves.

The position of bindery assistant skilled in the repair of rare and fragile old books has been vacant since October 1956, and so only 321 volumes from among the large number requiring special handling were repaired in the library. It is regrettable that there are now so few available craftsmen skilled in the hand-binding and repair of books.

The staff of the catalog section continued the work begun last year, partly in connection with the binding program, of sorting and arranging the accumulation of wholly uncataloged or incompletely cataloged publications in the library of the Bureau of American Ethnology. Those needed to fill gaps in sets, or found to be otherwise important to the work of the Bureau, were processed, and 4,406 others as well as 1,360 similar pieces culled from the main library shelves were discarded.

David Ray, foreign language specialist of the catalog section, was called upon frequently by staff members of the Institution to translate short letters written in different languages, including Russian, to make résumés, in English, of longer ones, and to give advice about meanings of special words and phrases. Requests for more extensive help, such as translating scientific articles from the Russian, had to

be refused, because they would have encroached too much on the time needed to do the regular cataloging of incoming foreign publications. It is apparent that the full time of a language specialist, whether attached to the library staff or to some other office of the Institution, might easily be occupied in making translations.

In the reference and circulation section, the record of 9,537 publications borrowed for use outside the library represented only a small part of the actual use of books and periodicals. To this figure might well be added the 8,493 publications that were sent to the sectional libraries for intramural circulation and filing, as indicative of the uncounted use of the library's collections that is made in all the bureaus, divisions, and sections throughout the Institution.

Interlibrary loans of 1,110 volumes were made to 116 Government and other libraries throughout the country. The largest borrowers were the Department of Agriculture, the Geological Survey, and the Indian Claims section of the Department of Justice. This library, in turn, borrowed 607 publications from libraries other than the Library of Congress, chiefly from the Department of Agriculture, the Geological Survey, and the National Library of Medicine.

Except as interlibrary loans, the library does not lend books to individuals outside the Institution, but it is freely open for reference to any responsible person. Among the 7,000 readers counted in the reference room during the year, there were occasional visitors from many different countries of all the continents, some of whom made more or less extensive use of the collections.

Some 13,000 reference questions of all degrees of difficulty, many of them requiring extensive bibliographical research, were answered in response to inquirers who came to the library in person or who wrote or telephoned for the information wanted.

A special summer task force, engaged in mid-June to help clear the west stacks for other use, has already made good headway in preparing duplicates, special collections, and other stored material for transfer elsewhere or for other suitable disposal. It is hoped that the project may be completed by September 1.

Following the death of Mrs. Hope Simmons, chief of the acquisitions section, just at the close of the preceding fiscal year, Mrs. L. Frances Jones was made acting chief of the section. Mrs. Elisabeth H. Gazin has continued to be chief of the reference and circulation section, and the catalog section has been headed by Miss Ruth Blanchard.

SUMMARIZED STATISTICS

ACCESSIONS

| | Volumes | Total recorded volumes, 1957 |
|--|---------|------------------------------|
| Smithsonian Deposit at the Library of Congress..... | 253 | 586, 700 |
| Smithsonian main library (including former Office and Museum libraries)..... | 8, 230 | 308, 613 |
| Astrophysical Observatory (including Radiation and Organisms)..... | 103 | 14, 945 |
| Bureau of American Ethnology..... | 1, 373 | 37, 350 |
| National Air Museum..... | 64 | 497 |
| National Collection of Fine Arts..... | 209 | 14, 079 |
| National Zoological Park..... | 12 | 4, 217 |
| Total..... | 10, 244 | 966, 401 |

Unbound volumes of periodicals, and reprints and separates from serial publications, of which there are many thousands, have not been included in these totals.

EXCHANGES

| | |
|--|-----|
| New exchanges arranged..... | 87 |
| Specially requested publications received..... | 485 |

CATALOGING

| | |
|--------------------------|---------|
| Volumes cataloged..... | 4, 044 |
| Catalog cards filed..... | 26, 184 |

PERIODICALS

| | |
|---|---------|
| Periodical parts entered..... | 23, 173 |
| 4,833 were sent to the Smithsonian Deposit. | |

CIRCULATION

| | |
|--|--------|
| Loans of books and periodicals..... | 9, 537 |
| Circulation in sectional libraries is not counted except in the Division of Insects. | |

BINDING AND REPAIR

| | |
|--------------------------------------|---------|
| Volumes sent to the bindery..... | 11, 900 |
| Volumes repaired in the library..... | 321 |

Respectfully submitted,

LEILA F. CLARK, *Librarian.*

Dr. LEONARD CARMICHAEL,
Secretary, Smithsonian Institution.

Report on Publications

SIR: I have the honor to submit the following report on the publications of the Smithsonian and its branches for the year ended June 30, 1957:

The publications of the Smithsonian Institution are issued partly from federally appropriated funds (Smithsonian Reports and publications of the National Museum, the Bureau of American Ethnology, and the Astrophysical Observatory) and partly from private endowment funds (Smithsonian Miscellaneous Collections, publications of the Freer Gallery of Art, and some special publications). The Institution also edits and publishes under the auspices of the Freer Gallery of Art the series *Ars Orientalis*, which appears under the joint imprint of the University of Michigan and the Smithsonian Institution. The second volume in this series was about ready to print at the end of the year. In addition, the Smithsonian publishes a guide book, a picture pamphlet, post cards and a post-card folder, a color-picture album, color slides, a filmstrip of Smithsonian exhibits, and popular publications on scientific and historical subjects related to its important exhibits and collections for sale to visitors. Through its publication program the Smithsonian endeavors to carry out its founder's expressed desire for the diffusion of knowledge.

During the year the Institution published 15 papers and title page and contents of 3 volumes in the Miscellaneous Collections; 1 Annual Report of the Board of Regents and separates of 19 articles in the General Appendix of the Report; 1 Annual Report of the Secretary; 2 special publications; and a reprint of 1 special publication.

The United States National Museum issued 1 Annual Report, 17 Proceedings papers and title page, table of contents, and index to 1 volume of the Proceedings, 5 Bulletins, and 1 paper in the series Contributions from the United States National Herbarium.

The Bureau of American Ethnology issued 1 Annual Report, 2 Bulletins, and 1 miscellaneous publication.

The Astrophysical Observatory issued 6 numbers in the series Smithsonian Contributions to Astronomy.

The National Collection of Fine Arts published 2 catalogs, and the Smithsonian Traveling Exhibition Service, under the National Collection of Fine Arts, published special catalogs for two of its circulating exhibits.

There were distributed 405,266 copies of publications and miscellaneous items. Publications: 32 Contributions to Knowledge, 31,786

Miscellaneous Collections, 8,252 Annual Reports and 17,658 pamphlet copies of Report separates, 449 War Background Studies, 24,136 special publications, 475 reports of the Harriman Alaska Expedition, 46,378 publications of the National Museum, 28,558 publications of the Bureau of American Ethnology, 20,907 publications of the National Collection of Fine Arts, 574 publications of the Freer Gallery of Art, 6,370 publications of the Astrophysical Observatory, 228 reports of the American Historical Association, and 1,147 publications not issued by the Smithsonian Institution. Miscellaneous: 74 sets and 540 prints of North American Wildflowers and 3 Pitcher Plant volumes, 60,621 guide books, 16,720 picture pamphlets, 128,896 post cards and post-card folders, 809 photo sets, 16,456 color slides, 4,666 color-picture albums, 64,406 information leaflets, 41 New Museum of History and Technology pamphlets, and 139 statuettes.

The 1957 allotment from Government funds of \$152,000 for printing and binding was entirely obligated at the close of the year.

SMITHSONIAN PUBLICATIONS

SMITHSONIAN MISCELLANEOUS COLLECTIONS

VOLUME 125

Title page and table of contents. (Publ. 4262.) [August 16], 1956.

VOLUME 126

Title page and table of contents. (Publ. 4263.) [August 16], 1956.

VOLUME 128

Title page and table of contents. (Publ. 4264.) [August 16], 1956.

VOLUME 129

Small arms and ammunition in the United States Service, 1776-1865, by Berkeley R. Lewis. 338 pp., 52 pls., 28 figs. (Publ. 4254.) August 14, 1956. (\$8.00.)

VOLUME 130

Annotated, subject-heading bibliography of termites, 1350 B. C. to A. D. 1954, by Thomas E. Snyder. 305 pp. (Publ. 4258.) September 25, 1956. (\$4.00.)

VOLUME 131

No. 7. The upper Paleocene Mammalia from the Almy formation in western Wyoming, by C. Lewis Gazin. 18 pp., 2 pls. (Publ. 4252.) July 31, 1956. (35 cents.)

No. 8. The geology and vertebrate paleontology of upper Eocene strata in the northeastern part of the Wind River Basin, Wyoming. Pt. 2. The mammalian fauna of the Badwater area, by C. Lewis Gazin. 35 pp., 3 pls., 1 fig. (Publ. 4257.) October 30, 1956. (55 cents.)

No. 9. Breeding and other habits of the casqued hornbills, by Lawrence Kilham. 45 pp., 6 pls., 2 figs. (Publ. 4259.) (70 cents.)

- No. 10. Crustacean metamorphoses, by R. E. Snodgrass. 78 pp., 28 figs. (Publ. 4260.) October 17, 1956. (80 cents.)
- No. 11. The ventral intersegmental thoracic muscles of cockroaches, by L. E. Chadwick. 30 pp., 18 figs. (Publ. 4261.) January 15, 1957. (40 cents.)

VOLUME 134

- No. 1. Periods related to 273 months or 22¾ years, by C. G. Abbot. 17 pp., 7 figs. (Publ. 4265.) September 13, 1956. (20 cents.)
- No. 2. The Asiatic species of birds of the genus *Criniger* (Aves: Pycnonotidae), by H. G. Deignan. 9 pp. (Publ. 4266.) October 25, 1956. (20 cents.)
- No. 3. Loop development of the Pennsylvanian terebratulid *Cryptacanthia*, by G. Arthur Cooper. 18 pp., 2 pls., 12 figs. (Publ. 4267.) (35 cents.)
- No. 4. Geology and vertebrate paleontology of upper Eocene strata in the northeastern part of the Wind River Basin, Wyoming. Pt. 1. Geology, by Harry A. Tourtelot. 27 pp., 1 pl., 7 figs. (Publ. 4269.) March 27, 1957. (45 cents.)
- No. 5. Trochamminidae and certain Lituolidae (Foraminifera) from the Recent brackish-water sediments of Trinidad, British West Indies, by John B. Saunders. 16 pp., 4 pls. (Publ. 4270.) March 15, 1957. (35 cents.)
- No. 6. Studies by phase-contrast microscopy on distribution of patterns of hemolymph coagulation in insects, by Charles Grégoire. 35 pp., 1 pl., 4 figs. (Publ. 4271.) May 8, 1957. (60 cents.)
- No. 7. Early White influence upon Plains Indian painting: George Catlin and Carl Bodmer among the Mandan, 1832-1834, by John C. Ewers. 11 pp., 12 pls. (Publ. 4292.) April 24, 1957. (50 cents.)
- No. 8. A skull of the Bridger Middle Eocene creodont *Patriofelis ulta* Leidy, by C. Lewis Gazin. 20 pp., 4 pls. (Publ. 4293.) April 30, 1957. (40 cents.)

ANNUAL REPORTS

Report for 1955.—The complete volume of the Annual Report of the Board of Regents for 1955 was received from the printer October 22, 1956:

Annual Report of the Board of Regents of the Smithsonian Institution showing the operations, expenditures, and condition of the Institution for the year ended June 30, 1955. ix+537 pp., 70 pls., 24 figs. (Publ. 4232.)

The general appendix contained the following papers (Pubs. 4233-4252):

- Science serving the Nation, by Lee A. DuBridgce.
- The development of nuclear power for peaceful purposes, by Henry D. Smyth.
- The time scale of our universe, by E. J. Öpik.
- Solar activity and its terrestrial effects, by Sir Harold Spencer Jones.
- Forty years of aeronautical research, by J. C. Hunsaker.
- A transatlantic cable, by H. A. Affel.
- Genetics in the service of man, by Bentley Glass.
- Cultural status of the South African man-apes, by Raymond A. Dart.
- The history of the mechanical heart, by George B. Griffenhagen and Calvin H. Hughes.
- Some chemical studies on viruses, by Wendell M. Stanley.
- The scent language of honey bees, by Ronald Ribbands.
- The army ants, by T. C. Schneirla.

The hibernation of mammals, by L. Harrison Matthews.

Parasites common to animals and man, by Benjamin Schwartz.

Some observations on the functional organization of the human brain, by Wilder Penfield.

The place of tropical soils in feeding the world, by Robert L. Pendleton.

Tree rings and history in the western United States, by Edmund Schulman.

New light on the dodo and its illustrators, by Herbert Friedmann.

George Catlin, painter of Indians and the West, by John C. Ewers.

Report for 1956.—The Report of the Secretary, which will form part of the Annual Report of the Board of Regents to Congress, was issued on January 18, 1957:

Report of the Secretary and financial report of the Executive Committee of the Board of Regents for the year ended June 30, 1956. ix+211 pp., 8 pls. (Publ. 4268.)

SPECIAL PUBLICATIONS

The national aeronautical collections, by Paul E. Garber. 166 pp., illustr. (Publ. 4255.) [August 20], 1956. (\$1.50.)

The world of the dinosaurs, by David H. Dunkle. 22 pp., illustr. (Publ. 4296.) [May 24], 1957. (50 cents.)

REPRINTS

A biographical sketch of James Smithson, by Samuel Pierpont Langley. 20 pp., 4 pls. Smithsonian Spec. Publ. 2276. 1956. (50 cents.)

FILMSTRIP

Let's Visit the Smithsonian, a filmstrip with 48 color views of the buildings, exhibits, and activities of the Institution, a recorded 30-minute lecture, and an accompanying booklet containing pictures and text. Produced under a grant from the Link Foundation by the Society for Visual Education. 1957. (\$10 complete; \$6.50 without record.)

PUBLICATIONS OF THE UNITED STATES NATIONAL MUSEUM

REPORT

The United States National Museum annual report for the year ended June 30, 1956. Pp. ix+105, illustr., January 18, 1957.

BULLETINS

185, part 6. Checklist of the coleopterous insects of Mexico, Central America, the West Indies, and South America, by Richard E. Blackwelder. Pp. viii+927-1492, May 15, 1957.

207. American moths of the subfamily Phycitinae, by Carl Heinrich. viii+581 pp., 1,138 figs., September 18, 1956.

209. Nearctic wasps of the subfamilies Pepsinae and Ceropalinae, by Henry Townes. iv+286 pp., 161 figs., 4 pls., March 11, 1957.

210. The first quarter-century of steam locomotives in North America: Remaining relics and operable replicas, with a catalog of locomotive models in the United States National Museum, by Smith Hempstone Oliver. 112 pp., 81 figs., frontispiece, August 6, 1956.

213. Automobiles and motorcycles in the U. S. National Museum, by Smith Hempstone Oliver. 157 pp., 103 figs., frontispiece, June 25, 1957.

PROCEEDINGS

VOLUME 104

Title page, table of contents, and index. Pp. i-iv, 651-694, June 5, 1957.

VOLUME 106

- No. 3364. Chiggers of the genus *Euschöngastia* (Acarina: Trombiculidae) in North America, by Charles E. Farrell. Pp. 85-235, 8 figs., 21 pls., October 19, 1956.
- No. 3365. A new pinecone fish, *Monocentris reedi*, from Chile, a new family record for the eastern Pacific, by Leonard P. Schultz. Pp. 237-239, 1 pl., July 24, 1956.
- No. 3366. Some crickets from South America (Grylloidea and Tridactyloidea), by Lucien Chopard. Pp. 241-293, 6 figs., September 20, 1956.
- No. 3367. The Nearctic species of tringonalid wasps, by Henry Townes. Pp. 295-304, 1 fig., October 16, 1956.
- No. 3368. *Latheticomyia*, a new genus of acalyprate flies of uncertain family relationship, by Marshall R. Wheeler. Pp. 305-314, 2 figs., October 2, 1956.
- No. 3369. A tribal revision of the brachycyrtine wasps of the world (Cryptinae—Ichneumonidae), by Luella M. Walkley. Pp. 315-329, 1 fig., October 16, 1956.
- No. 3370. A new species of *Candacia* (Copepoda: Calanoida) from the western North Atlantic Ocean, by Abraham Fleminger and Thomas E. Bowman. Pp. 331-337, 2 figs., October 15, 1956.
- No. 3371. Emended description and assignment to the new genus *Ronalea* of the idotheid isopod *Erichsonella pseudocolata* Boone, by Robert J. Menzies and Thomas E. Bowman. Pp. 339-343, 1 fig., October 17, 1956.
- No. 3372. Observations on the amphipod genus *Parhyale*, by Clarence R. Shoemaker. Pp. 345-358, 4 figs., October 15, 1956.
- No. 3373. A revision of the acrocerid flies of the genus *Pialea* Erichson with a discussion of their sexual dimorphism (Diptera), by Evert I. Schlinger. Pp. 359-375, 4 figs., October 12, 1956.
- No. 3374. Further data on African parasitic cuckoos, by Herbert Friedmann. Pp. 377-408, 4 pls., October 24, 1956.
- No. 3375. Studies in Neotropical Mallophaga, XVI: Bird lice of the suborder Ischnocera, by M. A. Carriker, Jr. Pp. 409-439, 9 figs., January 30, 1957.
- No. 3376. A new genus and species of marine asellote isopod, *Caecianiropsis psammophila*, from California, by Robert J. Menzies and Jean Pettit. Pp. 441-446, 3 figs., November 2, 1956.
- No. 3377. Mammals of the Anglo-Egyptian Sudan, by Henry W. Setzer. Pp. 447-587, 10 figs., November 28, 1956.

VOLUME 107

- No. 3378. A new species of *Mysidopsis* (Crustacea: Mysidacea) from the south-eastern coast of the United States, by Thomas E. Bowman. Pp. 1-7, 2 figs., February 15, 1957.
- No. 3379. *Rhynobrissus cuneus*, a new echinoid from North Carolina, by C. Wythe Cooke. Pp. 9-12, 1 pl., June 18, 1957.
- No. 3380. Formosan cossonine weevils of bamboo (Coleoptera: Curculionidae: Cossoninae), by Elwood C. Zimmerman. Pp. 13-23, 2 figs., March 25, 1957.

CONTRIBUTIONS FROM THE U. S. NATIONAL HERBARIUM

VOLUME 32

- Part 2. A revision of the genus *Nissolia*, by Velva E. Rudd. Pp. iii+173-206, 3 figs., November 7, 1956.

PUBLICATIONS OF THE BUREAU OF AMERICAN ETHNOLOGY

ANNUAL REPORT

Seventy-third Annual Report of the Bureau of American Ethnology, 1955-1956, ii+23 pp., 2 pls. 1957.

BULLETINS

Bulletin 161. Seminole music, by Frances Densmore. xxviii+223 pp., 18 pls., 1 fig. 1956.

Bulletin 162. Guaymf grammar, by Ephraim S. Alphonse. ix+128 pp. 1956.

MISCELLANEOUS PUBLICATIONS

List of publications of the Bureau of American Ethnology, with index to authors and titles. Revised to June 30, 1956. 112 pp. 1956.

PUBLICATIONS OF THE ASTROPHYSICAL OBSERVATORY

SMITHSONIAN CONTRIBUTIONS TO ASTROPHYSICS

VOLUME 1

No. 1. New horizons in astronomy. Thirty-nine papers, edited by Fred L. Whipple. Pp. i-x, 1-181, 6 figs., 1 pl. December 19, 1956.

No. 2. Papers on reduction methods for photographic meteors. Papers by Fred L. Whipple and Luigi G. Jacchia; Gerald S. Hawkins; Richard E. McCrosky; Allan F. Cook and Robert F. Hughes; and Fred L. Whipple and Frances W. Wright. Pp. 1-iii, 183-243, 4 figs., 5 pls. May 8, 1957.

VOLUME 2

No. 1. Notes on the solar corona and the terrestrial ionosphere, by Sydney Chapman, with a supplementary note by Harold Zirin. Pp. 1-14, February 18, 1957.

No. 2. Chromospheric spicules, by Sarah Lee Lippincott. Pp. 15-23, 6 figs., 4 pls. June 14, 1957.

No. 3. Studies of solar granulation: I. The statistical interpretation of granule structure from one-dimensional microphotometer tracings, by Gerard Wlérick. Pp. 25-34, 8 figs. June 14, 1957.

No. 4. Variations in the thermodynamic state of the chromosphere over the sunspot cycle, by R. G. Athay, D. H. Menzel, and F. Q. Orrall. Pp. 35-50, 9 figs. June 14, 1957.

PUBLICATIONS OF THE NATIONAL COLLECTION OF FINE ARTS

Meissen and other German porcelain in the Alfred Duane Pell collection, by Paul Vickers Gardner. 66 pp., 31 pls., 11 figs. (Publ. 4256.) 1956. (\$2.00.)

Alice Pike Barney: Paintings in oil and pastel. With introduction and biographical note by Thomas M. Beggs. 99 pls. (Publ. 4291.) 1957. (\$1.50.)

SMITHSONIAN TRAVELING EXHIBITION CATALOGS

Canadian abstract paintings. Illustr. 1956.

George Bellows prints and drawings. Illustr. 1957.

REPORT OF THE AMERICAN HISTORICAL ASSOCIATION

The annual reports of the American Historical Association are transmitted by the Association to the Secretary of the Smithsonian Institution and are by him communicated to Congress, as provided in the act of incorporation of the Association. The following report was issued during the year:

Annual Report of the American Historical Association for the year 1955. Vol. 1. Proceedings. 1957.

REPORT OF THE NATIONAL SOCIETY, DAUGHTERS OF THE AMERICAN
REVOLUTION

The manuscript of the Fifty-ninth Annual Report of the National Society, Daughters of the American Revolution, was transmitted to Congress, in accordance with law, on April 1, 1957.

Respectfully submitted.

PAUL H. OEHSER,

Chief, Editorial and Publications Division.

Dr. LEONARD CARMICHAEL,

Secretary, Smithsonian Institution.

Report of the Executive Committee of the Board of Regents of the Smithsonian Institution

For the Year Ended June 30, 1957

To the Board of Regents of the Smithsonian Institution:

Your executive committee respectively submits the following report in relation to the funds of the Smithsonian Institution, together with a statement of the appropriations by Congress for the Government bureaus in the administrative charge of the Institution.

SMITHSONIAN ENDOWMENT FUND

The original bequest of James Smithson was £104,960 8s. 6d.—\$508,318.46. Refunds of money expended in prosecution of the claim, freight, insurance, and other incidental expenses, together with payment into the fund of the sum of £5,015, which had been withheld during the lifetime of Madame de la Batut, brought the fund to the amount of \$550,000.

Since the original bequest, the Institution has received gifts from various sources, the income from which may be used for the general work of the Institution. These, plus accretions, are listed below, together with a statement showing the income for the present year.

ENDOWMENT FUNDS

(Income for the unrestricted use of the Institution)

Partly deposited in the United States Treasury at 6 percent and partly invested in stocks, bonds, and other holdings

| Fund | Investment 1957 | Income 1957 |
|---|--------------------|---------------|
| Parent Fund (original Smithson bequest, plus accumulated savings) | \$729, 218. 73 | \$43, 740. 94 |
| Subsequent bequests, gifts, and other funds, partly deposited in the U. S. Treasury and partly invested in the consolidated fund: | | |
| Abbott, W. L., Special..... | 19, 266. 29 | 1, 007. 04 |
| Avery, Robert S. and Lydia..... | 65, 079. 69 | 3, 509. 97 |
| Endowment..... | 457, 060. 68 | 23, 890. 54 |
| Habel, Dr. S..... | 500. 00 | 30. 00 |
| Hachenberg, George P. and Caroline..... | 5, 200. 82 | 271. 55 |
| Hamilton, James..... | 3, 022. 02 | 177. 29 |
| Henry, Caroline..... | 1, 563. 98 | 81. 75 |
| Hodgkins, Thomas G..... | 155, 173. 52 | 9, 007. 61 |
| Olmsted, Helen A..... | 1, 036. 08 | 54. 18 |
| Porter, Henry Kirke..... | 370, 358. 60 | 19, 358. 62 |
| Rhees, William Jones..... | 1, 201. 81 | 67. 38 |
| Sanford, George H..... | 2, 251. 16 | 126. 14 |
| Witherspoon, Thomas A..... | 166, 885. 20 | 8, 723. 08 |
| Total..... | 1, 248, 599. 85 | 66, 305. 45 |
| Grand Total..... | 1, 977, 818. 58 | 110, 046. 39 |

The Institution holds also a number of endowment gifts, the income of each being restricted to specific use. These, plus accretions to date, are listed below, together with income for the present year.

| Fund | Investment 1957 | Income 1957 |
|---|---------------------|-------------------|
| Abbott, William L., for investigations in biology..... | \$135,097.58 | \$7,047.04 |
| Arthur, James, for investigations and study of the sun and annual lecture on same..... | 51,718.65 | 2,703.32 |
| Bacon, Virginia Purdy, for traveling scholarship to investigate fauna of countries other than the United States..... | 64,789.42 | 3,386.56 |
| Baird, Lucy H., for creating a memorial to Secretary Baird..... | 31,135.76 | 1,627.48 |
| Barney, Alice Pike, for collection of paintings and pastels and for encouragement of American artistic endeavor..... | 37,090.52 | 1,938.71 |
| Barstow, Frederick D., for purchase of animals for Zoological Park..... | 1,292.87 | 67.59 |
| Canfield Collection, for increase and care of the Canfield collection of minerals..... | 49,460.38 | 2,585.28 |
| Casey, Thomas L., for maintenance of the Casey collection and promotion of researches relating to Coleoptera..... | 16,209.36 | 847.26 |
| Chamberlain, Francis Lea, for increase and promotion of Isaac Lea collection of gems and mollusks..... | 36,416.63 | 1,903.53 |
| Dykes, Charles, for support in financial research..... | 55,682.00 | 2,910.18 |
| Eickemeyer, Florence Brevoort, for preservation and exhibition of the photographic collection of Rudolph Eickemeyer, Jr..... | 14,056.61 | 734.75 |
| Hanson, Martin Gustav and Caroline Runice, for some scientific work of the Institution, preferably in chemistry or medicine..... | 11,496.22 | 402.98 |
| Higbee, Harry, Memorial Fund, for general use of the Institution after the period of 10 years from date of gift (1957)..... | 651.53 | None |
| Hillyer, Virgil, for increase and care of Virgil Hillyer collection of lighting objects..... | 8,499.03 | 444.23 |
| Hitchcock, Albert S., for care of the Hitchcock Agrostological Library..... | 2,040.55 | 106.66 |
| Hodgkins, specific, for increase and diffusion of more exact knowledge in regard to nature and properties of atmospheric air..... | 100,000.00 | 6,000.00 |
| Hrdlička, Aleš and Marie, to further researches in physical anthropology and publication in connection therewith..... | 50,539.03 | 2,510.45 |
| Hughes, Bruce, to found Hughes alcove..... | 24,753.23 | 1,293.84 |
| Loeb, Morris, for furtherance of knowledge in the exact sciences..... | 112,704.44 | 5,891.06 |
| Long, Annette and Edith C., for upkeep and preservation of Long collection of embroideries, laces, and textiles..... | 702.18 | 36.73 |
| Maxwell, Mary E., for care and exhibition of Maxwell collection..... | 25,365.22 | 1,325.83 |
| Myer, Catherine Walden, for purchase of first-class works of art for use and benefit of the National Collection of Fine Arts..... | 26,121.00 | 1,365.37 |
| Nelson, Edward W., for support of biological studies..... | 26,349.32 | 1,251.85 |
| Noyes, Frank B., for use in connection with the collection of dolls placed in the U. S. National Museum through the interest of Mr. and Mrs. Noyes..... | 1,242.43 | 64.93 |
| Pell, Cornelia Livingston, for maintenance of Alfred Duane Pell collection..... | 9,585.64 | 501.01 |
| Poore, Lucy T. and George W., for general use of the Institution when principal amounts to \$250,000..... | 220,684.42 | 11,158.09 |
| Rathbun, Richard, for use of division of U. S. National Museum containing Crustacea..... | 13,754.25 | 718.95 |
| Reid, Addison T., for founding chair in biology, in memory of Asher Tunis..... | 34,319.05 | 1,868.68 |
| Roebing Collection, for care, improvement, and increase of Roebing collection of minerals..... | 156,071.71 | 8,157.87 |
| Roebing Solar Research..... | 39,285.46 | 2,184.11 |
| Rollins, Miriam and William, for investigations in physics and chemistry..... | 135,217.06 | 6,486.66 |
| Smithsonian employees' retirement..... | 32,573.79 | 1,733.44 |
| Springer, Frank, for care and increase of the Springer collection and library..... | 23,190.43 | 1,212.15 |
| Strong, Julia D., for benefit of the National Collection of Fine Arts..... | 12,929.83 | 675.85 |
| Walcott, Charles D. and Mary Vaux, for development of geological and paleontological studies and publishing results of same..... | 618,547.12 | 32,433.75 |
| Walcott, Mary Vaux, for publications in botany..... | 74,856.02 | 3,912.71 |
| Younger, Helen Walcott, held in trust..... | 85,733.85 | 4,676.71 |
| Zerbee, Frances Brinckle, for endowment of aquaria..... | 1,226.64 | 64.13 |
| Total | 2,341,389.23 | 122,229.74 |

FREER GALLERY OF ART FUND

Early in 1906, by deed of gift, Charles L. Freer, of Detroit, gave to the Institution his collection of Chinese and other Oriental objects of art, as well as paintings, etchings, and other works of art by Whistler, Thayer, Dewing, and other artists. Later he also gave funds for construction of a building to house the collection, and finally in his will, probated November 6, 1919, he provided stocks and securities to the estimated value of \$1,958,591.42, as an endowment fund for the operation of the Gallery. The fund now amounts to \$7,915,270.67.

SUMMARY OF ENDOWMENTS

| | |
|---|-------------------------|
| Invested endowment for general purposes..... | \$1, 977, 818. 58 |
| Invested endowment for specific purposes other than Freer endowment | 2, 341, 389. 23 |
| Total invested endowment other than Freer..... | 4, 319, 207. 81 |
| Freer invested endowment for specific purposes..... | 7, 915, 270. 67 |
| Total invested endowment for all purposes..... | 12, 234, 478. 48 |

CLASSIFICATION OF INVESTMENTS

| | |
|---|-------------------------|
| Deposited in the U. S. Treasury at 6 percent per annum, as authorized in the U. S. Revised Statutes, sec. 5591..... | \$1, 000, 000. 00 |
| Investments other than Freer endowment (cost or market value at date acquired) : | |
| Bonds..... | \$1, 270, 497. 53 |
| Stocks..... | 2, 023, 334. 66 |
| Real estate and mortgages..... | 5, 846. 00 |
| Uninvested capital..... | 19, 529. 62 |
| | <u>3, 319, 207. 81</u> |
| Total investments other than Freer endowment..... | 4, 319, 207. 81 |
| Investments of Freer endowment (cost or market value at date acquired) : | |
| Bonds..... | \$4, 829, 318. 79 |
| Stocks..... | 3, 085, 059. 87 |
| Uninvested capital..... | 892. 01 |
| | <u>7, 915, 270. 67</u> |
| Total investments..... | 12, 234, 478. 48 |

ASSETS

Cash :

| | |
|---|------------------------|
| United States Treasury current account..... | \$1, 541, 981. 31 |
| In banks and on hand..... | 362, 090. 88 |
| | <u>1, 904, 072. 19</u> |

ASSETS—Continued

| | | | |
|---|-------------------|-------------------|-------------------|
| Less uninvested endowment funds ----- | \$20, 421. 63 | | |
| | | \$1, 883, 650. 56 | |
| Travel and other advances----- | | 6, 497. 00 | |
| Cash invested (U. S. Treasury notes)----- | | 939, 115. 70 | |
| | | | \$2, 829, 263. 26 |
| Investments—at book value : | | | |
| Endowment funds : | | | |
| Freer Gallery of Art : | | | |
| Stocks and bonds-- | \$7, 914, 378. 66 | | |
| Uninvested cash---- | 892. 01 | | |
| | | 7, 915, 270. 67 | |
| Investments at book value other than Freer : | | | |
| Stocks and bonds----- | 3, 206, 697. 33 | | |
| Uninvested cash----- | 19, 529. 62 | | |
| Special deposit in U. S. Treasury at 6 percent interest ----- | 1, 000, 000. 00 | | |
| Other stocks and bonds---- | 87, 134. 86 | | |
| Real estate and mortgages-- | 5, 846. 00 | | |
| | | 4, 319, 207. 81 | |
| | | | 12, 234, 478. 48 |
| Total----- | | | 15, 063, 741. 74 |

UNEXPENDED FUNDS AND ENDOWMENTS

| | | | |
|---|-------------------|------------------|------------------|
| Unexpended funds : | | | |
| Income from Freer Gallery of Art endowment----- | | | \$583, 498. 24 |
| Income from other endowments : | | | |
| Restricted----- | \$368, 279. 95 | | |
| General ----- | 306, 682. 34 | | |
| | | 674, 962. 29 | |
| Gifts and contributions----- | | | 1, 570, 802. 73 |
| | | | 2, 829, 263. 26 |
| Endowment funds : | | | |
| Freer Gallery of Art----- | \$7, 915, 270. 67 | | |
| Other : | | | |
| Restricted----- | 2, 341, 389. 23 | | |
| General ----- | 1, 977, 818. 58 | | |
| | | 12, 234, 478. 48 | |
| Total----- | | | 15, 063, 741. 74 |

CASH BALANCES, RECEIPTS AND DISBURSEMENTS DURING
FISCAL YEAR 1957¹

| | | |
|--|-----------------|------------------------|
| Cash balance on hand June 30, 1956----- | | \$1, 034, 355. 59 |
| Receipts, other than Freer funds: | | |
| Income from investments----- | \$254, 083. 84 | |
| Gifts and contributions ² ----- | 2, 324, 648. 60 | |
| Books and publications----- | 55, 825. 93 | |
| Miscellaneous----- | 61, 719. 40 | |
| Employees' payroll withholdings and refund of advances (net)----- | 2, 264. 22 | |
| Proceeds from real estate----- | 326. 72 | |
| Proceeds from sale of securities (net): | | |
| Consolidated fund----- | 569, 412. 38 | |
| Current fund----- | 490, 237. 50 | |
| Other funds----- | 15, 395. 69 | |
| Total receipts other than Freer funds----- | | 3, 773, 914. 28 |
| Freer fund receipts: | | |
| Gift----- | \$25, 000. 00 | |
| Income from investments----- | 365, 341. 06 | |
| Miscellaneous----- | 71. 04 | |
| Books and publications----- | 6, 526. 39 | |
| Proceeds from sale of securities (net)----- | 1, 973, 005. 86 | |
| | | <u>2, 369, 944. 35</u> |
| Total----- | | <u>7, 178, 214. 22</u> |
| Disbursements other than Freer funds: | | |
| Administration----- | \$127, 479. 93 | |
| Publications----- | 65, 241. 44 | |
| Library----- | 1, 192. 53 | |
| Custodian fees and servicing securities----- | 4, 738. 96 | |
| Miscellaneous----- | 22, 322. 61 | |
| Researches and explorations ³ ----- | 1, 221, 855. 67 | |
| Purchase of securities (net): | | |
| Consolidated fund----- | 657, 496. 23 | |
| Current fund----- | 611, 346. 82 | |
| Other funds----- | 10, 467. 19 | |
| S. I. Retirement System----- | 2, 323. 32 | |
| Total disbursements other than Freer funds----- | | 2, 724, 464. 70 |
| Disbursements, Freer funds: | | |
| Salaries----- | \$125, 637. 86 | |
| Purchases for collection----- | 171, 733. 34 | |
| Custodian fees and servicing securities----- | 11, 246. 43 | |
| Purchase of securities (net)----- | 2, 178, 598. 22 | |
| Miscellaneous----- | 62, 461. 48 | |
| Total Freer disbursements----- | | <u>2, 549, 677. 33</u> |
| Total disbursements----- | | 5, 274, 142. 03 |
| Cash balance June 30, 1957----- | | 1, 904, 072. 19 |
| Total----- | | <u>7, 178, 214. 22</u> |

¹This statement does not include Government appropriations under administrative charge of the Institution.

²Includes receipts for IGY program.

³Includes disbursements for IGY program.

The practice of maintaining savings accounts in several of the Washington banks and trust companies has been continued during the past year, and interest on these deposits amounted to \$10,704.92.

Deposits are made in banks for convenience in collection of checks, and later such funds are withdrawn and deposited in the United States Treasury. Disbursement of funds is made by check signed by the Secretary of the Institution and drawn on the United States Treasury.

The Institution gratefully acknowledges gifts and grants from the following:

Mr. Claude C. Adams, gift to establish "The Harry Higbee Memorial Fund."
American Philosophical Society, grant for an eastern Ecuador archeological project of Clifford Evans and Betty J. Meggers.

American Philosophical Society and National Science Foundation, grants-in-aid for archeological research in Shanidar Cave, Northern Iraq.

Atomic Energy Commission, additional grant for the study of specific biological indicators of ionizing radiation and the mechanism of the action of such radiation.

Atomic Energy Commission, additional grant for the purpose of conducting a biochemical investigation of photomorphogenesis in green plants.

Atomic Energy Commission, grant for tritium, helium-3, and meteorite research.

Mrs. Laura D. Barney, additional gift for the Alice Pike Barney Memorial Fund.

Bollingen Foundation, Inc., gift for the purpose of publishing color illustrations for a manuscript by Elsie Clews Parsons.

Mr. and Mrs. J. Bruce Bredin, gifts for the Smithsonian-Bredin Expeditions Fund.

Carter Oil Company, grant for a research project on echinoid spines.

Carter Oil Company and Gulf Oil Corporation, grants for the Planktonic Foraminifera Project.

Colortone Press, grant to be used to defray the pre-press production costs of a booklet, "Adventure in Science at the Smithsonian."

Committee of the Weston United Nations Paintings, gift for the purchase, maintenance, and circulation of the six paintings depicting scenes during the construction of the United Nations buildings.

General Electric Company, gift to purchase the original Röntgen X-ray tube.

Geological Society of America, Inc., grant for the purpose of bringing Dr. Muir-Wood to the United States for collaboration for the revision of the manuscript on "The Morphology, Classification, and Life-Habits of the Productoidea."

John Simon Guggenheim Memorial Foundation, gift to assist the publication of "The Customs and Religion of the Ch'iang," by D. C. Graham.

E. P. Henderson, gift for editorial assistance in preparing notes on studies on meteorites.

Frank Morton Jones, gift to be used to further a project looking toward revisional study of lepidopterous family Psychidae.

Kevorkian Foundation, gift to the Freer Gallery of Art.

Edwin A. Link, additional gift for historical research (marine archeology).

The Link Foundation, grant for the purpose of preparing booklets, filmstrips, slides, and other educational materials.

Malcolm MacGregor, additional gift for the Philatelic Fund.

- National Geographic Society, grant for the National Geographic Society-Smithsonian Institution Ecuadorian Anthropological Fund.
- National Geographic Society, additional grant to complete the excavations and related work at the archeological site in Jackson County, Alabama.
- National Science Foundation, additional grant for study of physical changes in the Indian population of Hacienda Vicos.
- National Science Foundation, grants for an optical tracking and scientific analysis program for the U. S. Earth Satellite Program.
- National Science Foundation, additional grant to make possible the continuation of work of the Canal Zone Biological Area on Barro Colorado Island.
- National Science Foundation, additional grant for taxonomic study of the phanerogams of Colombia.
- National Science Foundation, additional grant for the support of research entitled "Monograph of Fresh-water Calanoid Copepods."
- National Science Foundation, additional grant for research on recent Foraminifera from Ifaluk Atoll.
- National Science Foundation, grant for the support of research entitled "Photoregulation of Growth in Plants."
- National Science Foundation, additional grant for research on "Taxonomy of the Bamboos."
- National Science Foundation, grant for a research project entitled "Earth Albedo Observations."
- National Science Foundation, grant for support of a "Third Symposium on Cosmical Gas Dynamics."
- National Science Foundation and U. S. Department of Agriculture, for the support of research entitled "Systematic Studies of Cerambycidae (Wood-boring Beetles)."
- National Science Foundation, grant for the support of research entitled "Morphology and Paleoeecology of Permian Brachiopods."
- Office of Naval Research, additional gift to perform psychological research studies.
- Office of Naval Research, additional gift to assist work in progress on the preparation of a synoptic catalog of the mosquitoes of the world.
- Office of Naval Research, gift to perform aeronautical research studies.
- Office of Naval Research, additional gift for research on mammalian hosts and their parasites.
- Nelson and Goldman Orchard Co., additional gift for biological studies.
- New York Zoological Society, gift for the Penguin Fund.
- W. Daniel Quattlebaum, gift to purchase American blown glass for the U. S. National Museum.
- United States Information Agency, grant for an exhibition of "Paintings by John Marin."
- United States Information Agency, grant for four copies of an exhibition entitled "This is the American Earth."
- For support of the Bio-Sciences Information Exchange:
- Atomic Energy Commission.
 - Department of the Air Force.
 - Department of the Army.
 - Department of the Navy.
 - National Science Foundation.
 - Public Health Service.
 - Veterans Administration.

Included in the above list of gifts and contributions are reimbursable contracts.

The foregoing report relates only to the private funds of the Institution.

The following appropriations were made by Congress for the Government bureaus under the administrative charge of the Smithsonian Institution for the fiscal year 1957:

| | |
|---------------------------------------|-------------------|
| Salaries and expenses..... | \$4, 425, 000. 00 |
| National Zoological Park..... | 720, 000. 00 |
| Museum of History and Technology..... | 33, 712, 000. 00 |

The appropriation made to the National Gallery of Art (which is a bureau of the Smithsonian Institution) was \$1,505,000.00.

In addition, funds were transferred from other Government agencies for expenditure under the direction of the Smithsonian Institution as follows:

| | |
|--|----------------|
| Working funds, transferred from the National Park Service, Interior Department, for archeological investigations in river basins throughout the United States..... | \$108, 500. 00 |
|--|----------------|

The Institution also administers a trust fund for partial support of the Canal Zone Biological Area, located on Barro Colorado Island in the Canal Zone.

AUDIT

The report of the audit of the Smithsonian private funds follows:

WASHINGTON, D. C., *September 19, 1957.*

THE BOARD OF REGENTS,
SMITHSONIAN INSTITUTION,
Washington 25, D. C.

We have examined the financial statements and schedules, as listed in the accompanying index, of the Smithsonian Institution relative to its private endowment funds and gifts (but excluding the National Gallery of Art and other departments, bureaus or operations administered by the Institution under Federal appropriations) for the year ended June 30, 1957. Our examination was made in accordance with generally accepted auditing standards, and accordingly included such tests of the accounting records and such other auditing procedures as we considered necessary in the circumstances.

The Institution maintains its accounts on a cash basis and does not accrue income and expenses. Land, buildings, furniture, equipment, works of art, living and other specimens and certain sundry property are not included in the accounts of the Institution.

In our opinion, the accompanying financial statements present fairly the position of the private funds and the cash and investments thereof of the Smithsonian Institution at June 30, 1957 (excluding the National Gallery of Art and other departments, bureaus or operations administered by the Institution under Federal appropriations) and the cash receipts and disbursements for

the year then ended, in conformity with generally accepted accounting principles applied on a basis consistent with that of the preceding year.

PEAT, MARWICK, MITCHELL & Co.

Respectfully submitted.

CLARENCE CANNON,
CARYL P. HASKINS,
ROBERT V. FLEMING,
Executive Committee.

GENERAL APPENDIX
to the
SMITHSONIAN REPORT FOR 1957

ADVERTISEMENT

The object of the GENERAL APPENDIX to the Annual Report of the Smithsonian Institution is to furnish brief accounts of scientific discovery in particular directions; reports of investigations made by staff members and collaborators of the Institution; and memoirs of a general character or on special topics that are of interest or value to the numerous correspondents of the Institution.

It has been a prominent object of the Board of Regents of the Smithsonian Institution from a very early date to enrich the annual report required of them by law with memoirs illustrating the more remarkable and important developments in physical and biological discovery, as well as showing the general character of the operations of the Institution; and, during the greater part of its history, this purpose has been carried out largely by the publication of such papers as would possess an interest to all attracted by scientific progress.

In 1880, induced in part by the discontinuance of an annual summary of progress which for 30 years previously had been issued by well-known private publishing firms, the Secretary had a series of abstracts prepared by competent collaborators, showing concisely the prominent features of recent scientific progress in astronomy, geology, meteorology, physics, chemistry, mineralogy, botany, zoology, and anthropology. This latter plan was continued, though not altogether satisfactorily, down to and including the year 1888.

In the report of 1889, a return was made to the earlier method of presenting a miscellaneous selection of papers (some of them original) embracing a considerable range of scientific investigation and discussion. This method has been continued in the present report for 1957.

Reprints of the various papers in the General Appendix may be obtained, as long as the supply lasts, on request addressed to the Editorial and Publications Division, Smithsonian Institution, Washington 25, D. C.

Science, Technology, and Society¹

By L. R. HAFSTAD

*Vice President in charge of Research Staff
General Motors Corporation
Detroit, Mich.*

“WHEN ONE READS the history of science one has the exhilarating feeling of climbing a big mountain. The history of art gives one an altogether different impression. It is not at all like the ascension of a mountain, always upward whichever the direction of one’s path; it is rather like a leisurely journey across hilly country. One climbs up to the top of this hill or that, then down into another valley, perhaps a deeper one than any other, then up the next hill, and so forth and so on. An erratic succession of climaxes and anticlimaxes the amplitude of which cannot be predicted.” (1)²

Many will recognize the above as a quotation from George Sarton, the eminent historian of science, and will concur in the idea that in working in science one has indeed the “exhilarating feeling of climbing a mountain.” As working scientists, and fully recognizing that we may be naive, we still cling stubbornly to the faith that we are somehow contributing to human comfort and human happiness, and that however stumbling our progress, this progress is upward.

The great acceleration of both science and technology on a world-wide scale since the war seems to confirm this impression. So does the great increase in suggestions in books, and in articles in journals and periodicals, to the effect that we are on the threshold of a second industrial revolution. Many predictions are extant as to the high standard of living which will be obtainable in a matter of a few decades. The problem of the shortage of raw materials has been emphasized by various writers, but technological ingenuity in the de-

¹Presented before Sigma Xi and Scientific Research Society of America at the Annual Meeting of the American Association for the Advancement of Science, December 27, 1956. Reprinted by permission from *American Scientist*, vol. 45, No. 2, March 1957.

²Numbers in parentheses refer to notes at end of text.

velopment of substitutes is such that so far as *material* prosperity is concerned the possibilities do indeed seem limitless.

Much has been written in recent months about the shortage of scientists and engineers. This seems to be a worldwide problem and, as might be expected, is most acute where the development of technology is the most intense. It would seem to be axiomatic that the brave new world of plenty so earnestly desired cannot be attained without an adequate supply of scientists and engineers. To me, and I am sure to many of you, it seems somewhat surprising that so much campaigning and propaganda should be necessary to correct a shortage so obvious. In this area, however disappointing and annoying delays may have been, forces are now beginning to act in the direction to correct the dislocation. That at least is reassuring.

Following not more than a decade or two behind the Russians, in this country and in fact in the free world at large we are now belatedly beginning to use a very potent force—the incentive system—to correct the shortage. Once the forces acting can be identified, we can isolate trends and begin to foresee at least the immediate future. Accordingly, since this nation chose not to act on this problem until the shortage was upon us, I will now venture to predict the following sequence of events:

1. A continuation of the current hectic recruiting campaign with increasing salary scales for anyone with a semblance of training in science or technology, and particularly for people with advanced degrees.

2. A marked decrease in emphasis on quality in our schools to meet the increasing popular demand for quantity.

3. A period of progressively diminishing returns to industry and society from the attempt to substitute standardization and quantity for quality in an essential creative activity.

4. A period of disenchantment with paper credentials as a substitute for education, and finally a renewed appreciation of scholarship and achievement.

There is nothing either profound or new in this cycle. It is an example of the "hunting" process under the action of central forces, which is familiar to all of us. It is interesting, however, to speculate upon the time scale involved.

There is now public recognition of the problem created by the shortage of trained personnel of all kinds. It happens to be, however, just about 10 years since this problem with regard to scientists and engineers had already reached the table-pounding stage on the part of a few forward-looking individuals in Washington such as Vannevar Bush, Merriam Trytten, and Alan Waterman. We must conclude, then, that in matters of this kind our particular type of society

seems to have a time constant—an RC, or response time, if you please—of roughly 10 years. Successive responses to the four impulses listed above can therefore be predicted to require about 40 years! Now it is true that in the historical sense 40 years is not long in the life of a civilization, but one begins to wonder what the time constants are in competitive societies and how such societies are likely to react under similar impulses. Above all, one wonders why, with our highly developed communications facilities, our response times should be so surprisingly long.

Perhaps no small part of the explanation lies in the fact that scientists and engineers, who have long been aware of this situation, are, after all, a numerically very small fraction of our population. Added to this is the fact that the effects on a society of the activities of this group are invariably long delayed. A complete work stoppage on the part of the creative scientists would not, for example, be felt by our society as a whole for a decade or more. Thus it is difficult for the majority of our population to appreciate fully the function or significance of this relatively inconspicuous group. After all, the larger affairs of our society are, and no doubt always will be (and quite properly), handled by nontechnical people.

It is interesting to speculate about the somewhat anomalous situation into which we have gotten ourselves. There seems to be a tacit, but not clearly expressed, assumption that the purpose of the kind of society we favor is one which gives the greatest good to the greatest number. Our society has seized upon technology as a clearly applicable means to this end, so far as gratifying material wants is concerned. One would then assume that society, or more accurately the nontechnical controllers of that society, would as a matter of enlightened self-interest pay particular attention to the education and training of an adequate supply of what they refer to as "technicians." Instead, it is the technicians, the scientists and engineers, who have been calling for an increase in the supply of talent even though it would be to their own self-interest to restrict this supply of skills and thus improve their bargaining position. As scientists and engineers we ask the question from time to time, "For what and for whom are we working?" The sociologists from whom we assume we should expect a reply seem bewildered that the question should even be asked. By them technology seems to be considered as some extraneous activity apparently introduced or perpetrated by the scientists.

It is this deeper conflict in outlook and attitude between the humanist or sociologist and the scientist or engineer which gives me the greatest concern. The shortage of scientists *is* serious; but here the incentive forces are being brought into play in a direction to *correct*

the anomaly in due course. However, in the philosophical conflict, with our technology tending to become ever more complex, and with increasing specialization, unless *current educational trends are reversed*, the technical and nontechnical components of our society will continue to travel diverging paths, with hunting oscillations not of decreasing but of increasing amplitude.

As Sarton has pointed out, "The ominous conflict of our time is the difference of opinion, of outlook, between men of letters, historians, philosophers, the so-called humanists, on the one side, and scientists on the other." (2) Similarly, Mees has stated:

While the relation between the progress of scientific discovery and the structure of society is of the utmost interest and importance to those who desire to understand it or, still more, to control the changes that are occurring, there is a cleavage between those who follow the discipline of history and of the humanities and those who are eagerly pursuing the quest for scientific knowledge. Humanistic learning is the learning of the ancients; it is a study of the accumulated thought of mankind so far as it has been transmitted to us. Scientific knowledge, on the other hand, is a development arising from the observation of facts and their classification into patterns. The separation of these two types of learning has always been unfortunate; at present it is serious, and it may, indeed, be disastrous. (3)

Many of you will recall that there is a principle in physics which says that in order for energy to be transmitted efficiently from one electrical network to another it is necessary that there be an impedance match between the two circuits. Very similarly it has been my experience that for the transmission of information, or more accurately human understanding, between two individuals it is necessary that there be a matching of backgrounds. Historically such a matching has not existed between devotees of the humanities and of the sciences. As far as the development and enjoyment of the sciences by and for scientists are concerned, no matching is really necessary. Similarly, the humanities as a discipline are completely self-sufficient. If, however, the humanist chooses to *use* science as the basis of technology designed to advance the standard of living of mankind, then it becomes incumbent on the humanist to so fashion an educational system that *he* can communicate with scientists and engineers. This he has failed and is failing to do. Teaching less science and mathematics and more art and music to scientists may enrich the life of the scientist, but it will not help solve the basic problem of the humanist, which is to create what *he* has concluded to be the good society. If there is to be a sizable component of technology in his good society, he must at some point face up to the problem of matching impedances with the scientist.

Let us take a look at some of the facets of this problem which might have to be considered. Very early in my career as a student

I became aware of the definition, "Life *is* struggle," and in my day we were so reactionary that we even came to accept it. It also became clear to me that the struggle was for an intangible something called "progress." This was a much more elusive concept and one which I have found intriguing even up to this day. Somewhat surprisingly, I learned that the idea of progress was itself a relatively recent concept in human affairs. Still more significantly, it was not accepted without considerable opposition and conflict. People were burned at the stake! All this, of course, is spelled out in the literature and is particularly well summarized in the too little known book by Professor Bury (4). The important fact which emerges, however, is that the idea of progress and the development of technology are inextricably interlinked. As stated by Mees, "Technology is at once the source and the justification for the idea of progress." (5) That this is true seems to be accepted by scholars throughout the world as is evidenced, for example, by the determination of the underdeveloped countries to industrialize. The fact seems to be accepted everywhere except where it should be most obviously true and that is here in our own United States. Here in our society we demand progress—in fact, we seem to take it for granted as a law of nature—but there are influential people who seem to be doing their best in our education process to escape or circumvent science and technology, which alone can make progress possible.

Perhaps I have overstated my case. Let us hope so. But a review of some recent evidence may give us a perspective in which to view the problem. In a recent study of high-school students reported from Purdue (6) it was found that—

14 percent of the students think there is something evil about scientists.

30 percent believe that one cannot raise a normal family and become a scientist.

45 percent think their school background is too poor to permit them to choose science as a career.

9 percent believe that one cannot be a scientist and be honest.

25 percent think scientists as a group are more than a little bit "odd."

28 percent do not believe scientists have time to enjoy life.

35 percent believe that it is necessary to be a genius to become a good scientist.

27 percent think that scientists are willing to sacrifice the welfare of others to further their own interests.

This is indeed a devastating comment, either on scientists or on our educational process, or both. With this the attitude among students, can there be any mystery as to why there is currently a

shortage of scientists and engineers? Since the world managed to survive for some centuries before the advent of scientists or engineers, the attitudes expressed would be quite understandable if the students were or proposed to become mystics and lead the contemplative life, which certainly has its advantages. But these were normal American boys and girls demanding and getting 100-horsepower cars for transportation, radios, television, movies, juke boxes, and all the other paraphernalia of our modern civilization. How could they have grown to high-school or college age without learning the simple facts of cause and effect with respect to the technological civilization in which they are clearly planning to live?

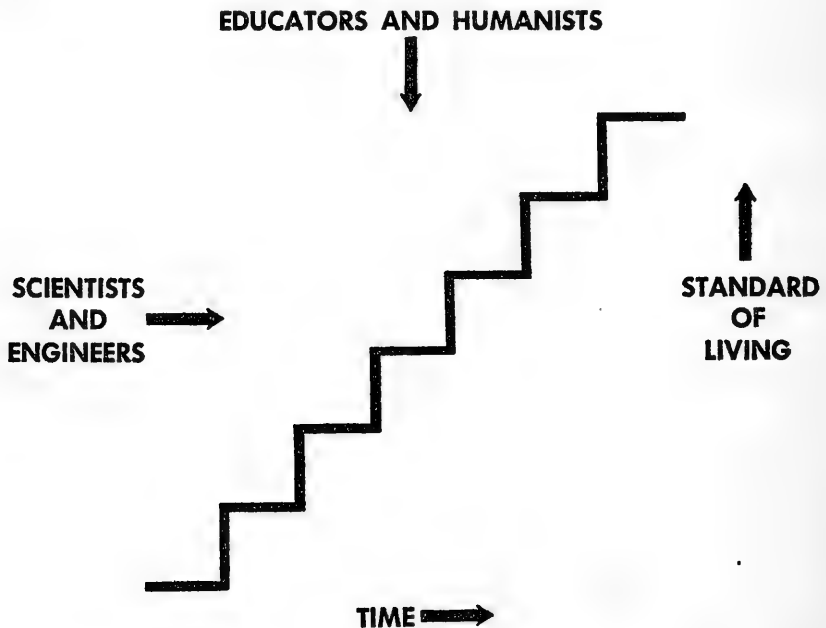

FIGURE 1.

In this respect our school system is quite inadequate, in my opinion. The shortage of scientists and engineers is bad enough, but with some effort these immediate shortages can be corrected since the total numbers needed are not really large in proportion to the population. What is more serious (and more dangerous in the long run) is that the mass of our population, who, in a society dedicated to the greatest good for the greater number, must in the end control it, remains in ignorance of the foundations on which that society is based.

The contrast between the studied complacency of the educators and the concern of scientists and engineers with regard to this situation can perhaps be emphasized or dramatized by Koestler's device of using a staircase to show the effects of different points of view bearing on the same problem. In figure 1 the humanist or so-called progressive

educator looking from above sees a series of plateaus or tableaux (since they are flat to him) and notes with amazement and delight that each successive tableau shows a successively higher standard of living. With only a limited imagination he can make the slight extrapolation to the point where no one has to work. Being foresighted he places great emphasis on training for leisure. Being also sufficiently observant to note an increase of population with time, and being aware of the frictions and struggles brought about by individual differences, great emphasis is also placed on standardization. For the convenience of all concerned, why shouldn't the "lowest common denominator" solution be picked? From his point of view it makes sense.

GROWTH OF WORLD POPULATION

TIME SCALE : 10,000 YEARS

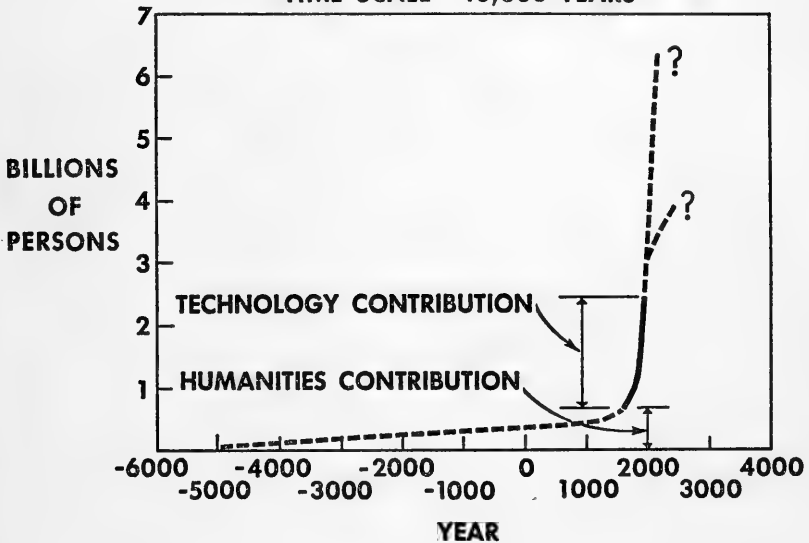

FIGURE 2.

Now look at the same staircase from the point of view of the scientist. He sees each plateau merely as a hesitation point between struggles to attain a higher level. To him progress represents work, and he is convinced that further progress cannot be made without struggle. To him there is nothing automatic or guaranteed in the comfortable and continuous progress which the humanist and progressive educator seem to take for granted.

A rough indication of the relative contributions of science and technology can be seen from figure 2, adapted from the book by Harrison Brown (7). This shows the extent to which science and technology have dominated modern life. Art, literature, poetry, warfare, trade, government, law—all have been with us from prehistoric times. As

H. G. Wells pointed out, the first episodes in recorded history involve the quarrels of Sumerian priests. Apparently none of the accomplishments of these groups was sufficient to break the monotonous cyclical rise and fall of the same kind and level of civilization in merely different locations, such as in China, Egypt, Greece, and Rome. Taking simple survival as the lowest level of human happiness and integrating for all mankind, we find a total contribution for the humanities, as given by an extrapolation to the present time, of the first part of the curve of figure 2. The rapid growth of the population curve after the seventeenth century is commonly attributed to the development of science and technology, so the relative contribution of these disciplines to humanity as a whole can be taken as roughly three to one over that of what used to be called the humanities. Considering the relative contribution of these two kinds of activities to the good of mankind, one wonders whether perhaps the names should not be interchanged!

Since our society has chosen for itself a kind of civilization which is so overwhelmingly dependent on advances in science and technology, it is only prudent to ask how we can expedite our progress in these fields. Here is where the shortage of scientists and engineers comes in. I will not attempt to review but merely cite some of the many excellent and realistic articles on this subject. Significant, in my opinion, are recent articles by Stratton, Rassweiler, Rickover, Bestor, and Beckman (8).

These articles, by unquestioned authorities in their fields, point out inadequacies in our present educational system in so far as the production of technical personnel is concerned. I agree heartily, but I wish to make a deeper criticism. Even if an entirely separate educational channel were provided which more than supplied our foreseeable needs for engineers, I contend that the education of the rest of the citizenry should include a basic understanding and appreciation of our technological society, both its strengths and its limitations. Above all, at some point in the education process it should perhaps be brought to the attention of the students (very delicately, to be sure, to avoid psychological trauma) that progress cannot be made without struggle, nor freedom enjoyed without personal responsibility.

It has long been my contention that those who have *done* should teach, and accordingly that those who have taken an active part in creating our technological society should be best able to interpret it for others. Unfortunately the very shortage of technical talent exerts great pressures on individuals skilled in these fields to concentrate on technical problems. Scientists and engineers are notoriously inarticulate, so a suitable education should include a heavy concentration on the arts of communication. This might be acquired in our elementary

or secondary schools, but in our present predominantly superkindergarten system of education it is postponed until college. Here it is in conflict with the needs of ever more highly specialized professional training. The engineer remains inarticulate and the general public uninformed; thus the impedance mismatch is continuously increased, not decreased, and must eventually approach instability.

Dr. Glenn Frank stated this problem with fine understanding. He said,

The practical value of every social invention or material discovery depends upon its being adequately interpreted to the masses. The future of scientific progress depends as much on the interpretative mind as it does upon the creative mind. . . . The interpreter stands between the layman, whose knowledge of all things is indefinite—and the scientist whose knowledge of one thing is authoritative. . . . The scientist advances knowledge. . . . The interpreter advances progress. . . . History affords abundant evidence that civilization has advanced in direct ratio to the efficiency with which the thought of the thinkers has been translated into the language of the masses. (9)

In contacts with students and even with reasonably informed grownups, I have found not only that such simple and basic things as the relation between research and engineering, between technology and the standard of living, or between progress and incentive, are not understood but also that the discussion of these concepts is itself a fascinating *new* experience. An Operations Research approach to some of these problems might prove quite rewarding.

Here are some simple examples which I have found to stimulate considerable interest in discussion groups.

First, in regard to the relation between science and engineering or research and engineering, let us look at figure 3. This graph shows the usual growth curve for costs of a project of some kind. Note that the costs during the research or information-gathering phase are small. It is only at the beginning of the development or invention phase that there is anything tangible to consider and that costs begin to mount. It is here that the businessman first begins to take an interest, and it is this phase of the effort which he considers important.

To a research man, however, the picture looks entirely different. The business of the researcher is to get really new information, to discover a relationship which previously had never been known, to do something—not better or cheaper than somebody else—but to do something for the first time in the history of the human race. Research discoveries are rarely spectacular but may nevertheless be highly significant. Thus, to bring out what is important in research we might plot, not dollars expended, but the ratio of the information available in a certain field before an experiment to that available after the experiment. If something truly new has been discovered,

this ratio becomes infinite and a replot of our previous figure in terms of this information ratio becomes as shown in figure 4. This curve emphasizes *basic* research, the acquisition of knowledge for its own sake.

DEVELOPMENT CONTRIBUTION

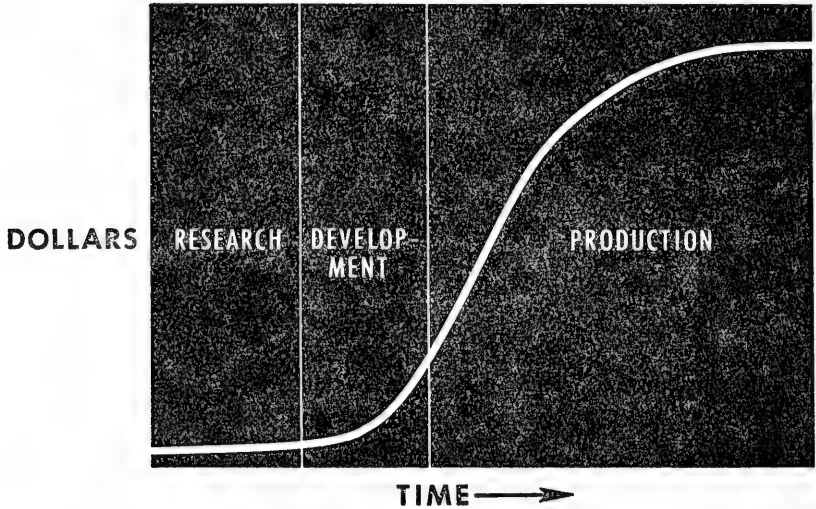

FIGURE 3.

The scientist's work as a scientist is completed when a new item of information is established and recorded. It is no concern of the scientist, as a scientist, whether the information is useful or not. It is for this reason that we can say with conviction that it is *not* scientists who create technology. It is society itself which chooses to create a technology based on the information which the scientist has uncovered. This problem of application is the function of the engineer. At the beginning of the scientific era, science and engineering were widely separated in time. With the development of our current technological civilization, applications have followed more and more closely on the heels of discovery, with the result that in many fields the search for new information and understanding is carried out simultaneously with the application—that is, the effort to solve some practical problem. Though activities may overlap, the distinction in function remains. The same man who makes a discovery may choose, or be persuaded, to attempt to apply it to a practical problem. In this case he ceases to be a scientist and works essentially as an engineer, and is motivated not internally as a scientist but externally by society. I dwell on this point to counter the argument often advanced that it is the scientist who has created the complexities of

our modern industrial civilization. I maintain it is not. It is society itself, and particularly the nontechnical part of society, which creates the demands that are the motive force behind our technology.

Let us turn to another basic question, the relations between standards of living, education, and technology. Much of the energy in our educational system these days is focused on new theories of teaching which will avoid grading and thus any semblance of conflict and competition. This is no doubt desirable sociologically, but apparently so is a rising standard of living. This presents a painful choice. In technology if incentive is removed, so is struggle, and if struggle is stopped, so is progress. This leveling process could, of course, be carried out at any point in the history of a civilization, so it is of interest to see what would have happened had it been carried out at some previous times in our own history. The results are shown in figure 5 (10). Who made the greatest real contribution to the goal of the humanist, the engineers or the self-appointed Robin Hoods of 1909, those people who thought all our social problems could be solved by a redistribution of the wealth at that time?

RESEARCH CONTRIBUTION

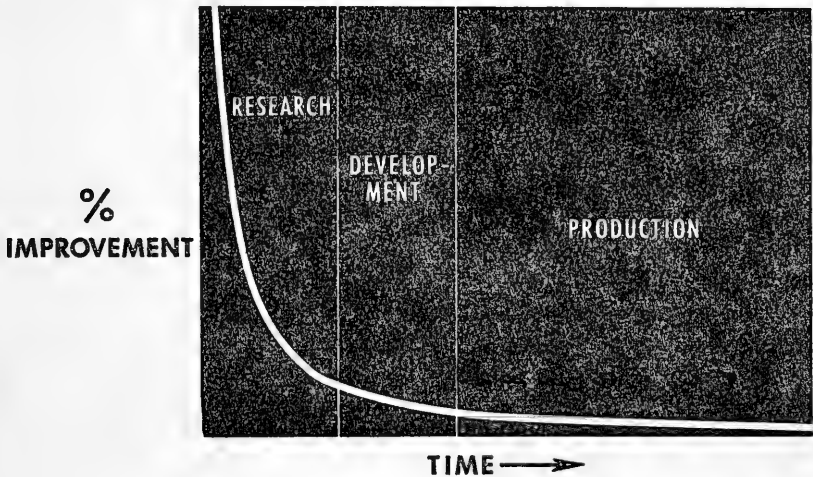

FIGURE 4.

Finally, let us consider a little further the relationship between incentive and progress. Let us assume, following the late Dr. Dickenson of the Bureau of Standards, that the actual innate abilities of a population are given by a probability distribution curve such as A in figure 6. As a base for comparison let us now imagine a perfectly "efficient and just" social system which extracted from each individual a contribution proportional to his ability and rewarded

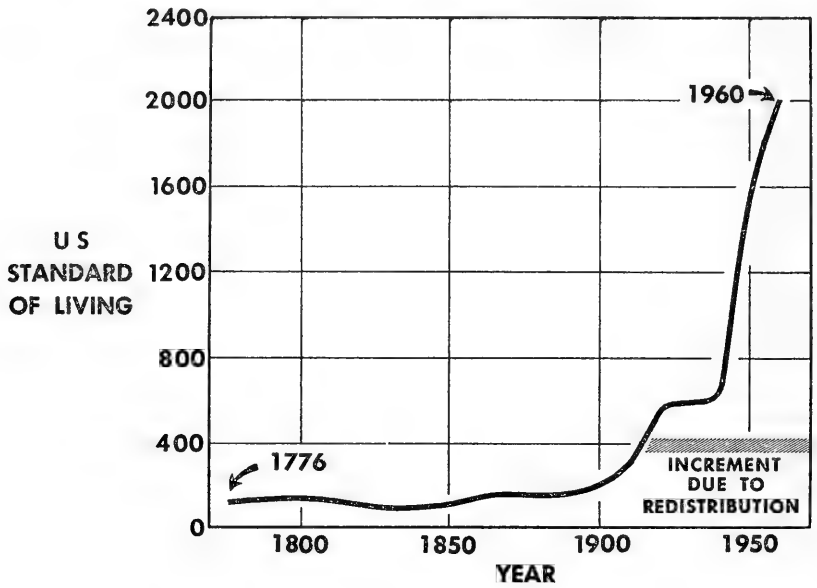

FIGURE 5.

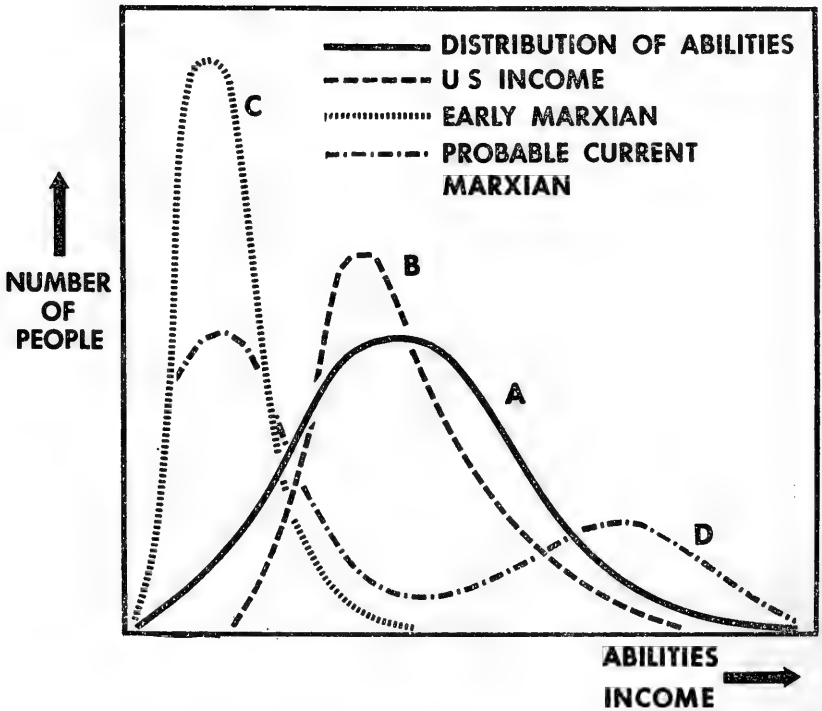

FIGURE 6.

him in accord with his contribution. The dollar income curve would then coincide precisely with the ability curve A. But there are many other criteria society can choose to specify the income curve. In the United States we originally chose to give "rate of progress" great importance in our specification, and emphasized incentive, but we balanced this with benefits for the underprivileged, which gave us a distribution curve, according to Dickenson, something like B. The Marxian criterion, on the other hand, was "From each according to his ability to each according to his need." The experiment was tried, as we all know, and according to reports resulted in a peaking of the curve just at or barely above the subsistence level, as in curve C. Clearly this represented a *sharing of poverty*, as Herbert Hoover has so aptly phrased it. This failure of a social theory forced the Soviet to adopt the "New Economic Plan," with a return to emphasis on *incentive* to bring out the potential contributions of the able. The new curve, of course, has a new specification which I am sure is intended to maximize progress. To attain such progress, however, the Communists have distorted their reward curve to some such curve as D, with the mass of the population at subsistence level and a pampered elite at the top. The stresses and strains thus introduced into their society are only now becoming evident.

In summary, there is a continuing divergence in point of view between the sciences and the humanities. With the sciences, through the mechanism of technology, being called upon to make an ever-increasing contribution to a society as specified by the humanists, there is serious cause for concern in the fact that the educational system at the elementary and secondary levels seems to be out of step from a systems-engineering point of view with the foreseeable needs of such a society. The desire for "progress" cannot be reconciled with the lack of attention to, and an incentive for, students of exceptional ability. Similarly the desire for "progress" is inconsistent with the trend toward effortless education, and the substitution of pastimes for disciplines. Finally, the assumption that a larger and larger population can be supported on and by the work of a smaller and smaller fraction of highly trained creative specialists leads to a social structure like that of an inverted pyramid. Even more acute than the current shortage of scientists and engineers is the shortage of people who both can and will carry responsibility.

With increasing complexity and specialization in the technical fields, the gap between the sciences and the humanities becomes an ever-widening one. This adverse tendency could be reduced by insuring that students of science were given a better grounding in the humanities, while students in the humanities were given a better background in science. This, however, would require *more* rather

than *less* disciplined study in both fields, and runs counter to the current educational trends.

NOTES

- (1) George Sarton, *The History of Science and the New Humanism*, p. 11, Harvard University Press, Cambridge, 1937.
- (2) *Ibid.*, p. 54.
- (3) C. E. K. Mees, *The Path of Science*, p. 15. New York.
- (4) J. B. Bury, *The Idea of Progress*, New York, 1932.
- (5) C. E. K. Mees, *The Path of Science*, p. 13. New York.
- (6) Report of Poll No. 45, *The Purdue Opinion Panel*, July 1956. Division of Educational Reference, Purdue University.
- (7) Harrison Brown, *The Challenge of Man's Future*, p. 49. New York, 1954.
- (8) The articles referred to are: J. A. Stratton, *Science and the educated man*, *Physics Today*, April 1956.
C. F. Rassweiler, *Producing more technical man power*, *Technology Review*, May 1956.
H. G. Rickover, *Engineering and scientific education*, *Technology Review*, April 1956.
H. G. Rickover, *The education of our talented children*, Thomas Edison Foundation, November 1956.
Arthur Bestor, *We are less educated than 50 years ago*, *U. S. News & World Report*, November 30, 1956.
Arnold O. Beckman, *A business man's view of the failure of education*, *U. S. News & World Report*, November 30, 1956.
- (9) Dr. Glenn Frank, late President of the University of Wisconsin.
- (10) The standard-of-living data are from a recent Brookings Institution study. The increment shows the increase in average standard of living due to a redistribution, or leveling, of income of all kinds, salaries, rents, dividends, etc.

Reprints of the various articles in this Report may be obtained, as long as the supply lasts, on request addressed to the Editorial and Publications Division, Smithsonian Institution, Washington 25, D. C.

United States Coast and Geodetic Survey, 1807–1957¹

By ELLIOTT B. ROBERTS

*Chief, Division of Geophysics
United States Coast and Geodetic Survey*

[With five plates]

WHEN the Coast and Geodetic Survey opened its doors to business on February 10, 1957, it became our Nation's first technical bureau to celebrate a 150th birthday, and one of the few agencies besides the Army, Navy, and other executive departments to reach such age. An infant bureau of the early nineteenth century has grown into a modern service responsible for much geographical exploration and scientific and technological accomplishment. The birthday of this service draws attention to its long history—one having many highlights of significance to the Navy.

It is hard to believe that only 150 years ago the charts of our coastal waters were so few and sketchy that navigation was uncertain and dangerous—that our 60,000 coasting vessels had to endure heavy losses each year because every move about the coast was an uncertain adventure. Isolated sketch maps from the British *Neptune*, the inadequate notes of Captain Southack and of the British *Pilot*, and the charts and sailing directions published by Blunt—all were incomplete and full of errors. The country was essentially without charts—of all instruments of navigation the most fundamental!

Thomas Jefferson and others, including members of the American Philosophical Society, had long agitated for a Federal program of hydrographic surveys. In 1807 Congress took care of the matter, in effect ordering complete surveys of our waterways, by authorizing the "Survey of the Coast," a new bureau to be assigned to the Treasury Department. The fledgling agency, for which no precedent existed, had a hard time getting started. After long delays, however, under the ministrations of a scientific genius who antagonized and

¹ Reprinted by permission from the U. S. Naval Institute Proceedings, February 1957.

angered almost all officialdom, it finally found its place in the growing land. As new territory was annexed, the job grew larger before it was even started. This undertaking, which Congress supposed would be finished in a few years, has now taken 150 years, and no end is in sight.

The "Survey of the Coast," known in midcentury as the "Coast Survey," eventually became the "Coast and Geodetic Survey" when, in 1878, its nationwide geodetic surveys, necessary as a foundation for maps, were recognized as a basic function. In 1903, the Survey was removed from the Treasury to what is now the Commerce Department. In its long history there have been many events and outstanding men, of which we can here glimpse but a few.

In this period of serving the maritime, mapping, and, more lately, the aviation interests of the country, the work of the Survey has brought it into continuous and often intimate relations with the military agencies. It has been merged on more than one occasion with the Navy, only to be separated again on the grounds that its highly specialized work required the administration of scientific rather than military heads. The Navy has, of course, long had its companion agency, the Hydrographic Office, for the discharge of commitments in foreign areas and those having special military significance. During long periods Navy officers served Survey duty assignments, often with great distinction. There still exists a law authorizing such assignments on the request of the Survey, but it has not been used since the Spanish-American War. Frequently, in the early days, Army officers, usually topographic engineers, were also so assigned.

Many of the skills of the Survey—reconnaissance surveying, geodetic work, photointerpretation, and chart production, for instance—have military significance. In every war its officers have served on direct detail with the military forces, engaging in many campaigns as surveyors and scouts, map compilers, pilots, and navigators. Its ships as well have performed many duties with the Navy. In part because of these military connotations of the work and the nature of its field operations and customs, the Survey became a commissioned service during World War I, subject to military duty in wartime. In World War II six of its ships served with the Navy, and numerous officers in ranks up to Captain were assigned duty in naval and other military commands, often in heavy combat.

When President Jefferson found himself charged by Congress with the duty of starting a national hydrographic survey, he asked the American Philosophical Society to recommend an expert to take charge. There were no established procedures, and so the Society invited proposals from respected engineers, including James Madison, for starting the work. The best plan of those received was from

a Swiss geodesist seeking a career in America, Ferdinand Hassler. It offered a brilliant solution and a work of high scientific quality, with astronomic determinations of "remarkable" points on the coast, a triangulation survey to establish controlling points for the detail work, and a nautical survey of the coastal waters, to show the shoals and the navigable channels. Hassler thus became the first Superintendent and organizer of the new bureau and the author of its creed. Because of his profound and lasting influence, he deserves much attention in any historical account of the Survey.

Hassler was ahead of his time. Where Congress meant to provide for the needs of the moment, he saw a chance to build for the future. Time and cost were not to be considered in meeting this challenging problem, which called for well-ordered development from a technically firm foundation. To fulfill this ideal was his determination. He was indomitable—also improvident, proud, and intolerant. His beginnings were understandably halting, while Congress cast him aside, then in despair called him back. Though by his nature he defeated his own ends, he did finally see his vision come true, after a lifetime of effort. His greatest gift to America was not the surveys he accomplished—it was his reverence for sound thinking, integrity, and accuracy, which have endured as basic elements of Survey philosophy.

Hassler had nothing at the outset. Needing theodolites and other scientific tools not available in America, he had first to visit Europe to get them. Copper of suitable quality for the chart engravings was lacking, as indeed were qualified engravers themselves, who could not be found nearer than Germany. In London he had a "great" theodolite of 24-inch circle built to his own design by E. Troughton. He collected reference books, standards of measurement, and other necessities. These dealings took a long time; moreover political disturbances intervened to lengthen his stay to years. His impractical zeal resulted in his exceeding his \$50,000 authorization, and he had to come back at his own expense, under severe censure.

Many things, including lack of funds, delayed the start of operations until 1816, when the first work in preparation for the survey of New York Harbor was undertaken. At the outset, arrangements for the measurement of a baseline near Long Branch were interrupted by the first of a long series of controversies—in this case a lawsuit about some branches of a cedar bush used as a temporary survey signal. This, however, was less serious than the impatience of Congress, which expected results practically overnight. Hassler's determination to build a strong foundation, with a geodetic survey before ever a sounding was taken, left Congress fuming with impatience and wondering what he was about. Financial support was withdrawn before the

submission of the first annual report of progress—thus there began another long period of inactivity while Congress tried to get along without Hassler.

His personal means gone, and a sufferer of personal privations, Hassler clung nevertheless to his dream. Temporary relief came in 1818 in the form of a commission to mark the New England Boundary with Canada, as required by the Treaty of Ghent. No one else could be found to do the job. A quarrel with the British surveyors developed over certain geodetic problems having to do with the ellipticity of the earth. Hassler carried his point, obtaining a favorable demarcation, and he thus became the first of many Coast Survey engineers to lay down, confirm, or adjust local or national boundaries—sometimes in the heat of controversy, as in the quarrel over “54-40 or fight!”

In 1830, because of Hassler’s interest in measurement standards, he was appointed superintendent of a new office of weights and measures by Congress. There he achieved success in standardizing measures in trade and industry. This related activity remained a specialty of the Survey for many years until the creation, in 1901, of the National Bureau of Standards. Hassler’s standards were painstaking copies of those in England, and it was America’s singular privilege, upon the burning of Parliament in 1843, to make England a present of new ones copied from Hassler’s copies!

The survey of the coast was resumed in 1832, after numerous false starts, with Hassler again in charge. He was the only man with the technical genius for the job—otherwise Congress would never have put up with his intolerance and irascibility. When Congressional committees waited upon him for explanations of his work and its delays, he dismissed them with scathing denunciation of their stupidity in presuming to question him—rebuffs that created much mirth in Congress and little in the way of financial support.

Among the points of issue with Congress was an estimated completion date, which he could not provide. Of course he could not! The original area of a few thousand square miles grew endlessly toward a final total of more than 100,000 miles of shorelines and 2,500,000 square miles of coastal lands and waters. Through the years, moreover, the demands of ever-deeper ships, advancing marine technology and increasing speeds have had to be met, as well as vexing problems of instability and change affecting much of the coast. Necessary re-surveys and growing technological requirements have been encountered while opening the dangerous waters of Alaska to sea commerce and giving the 7,000 islands of the Philippines the boon of modern charts.

By 1835, a substantial foundation of astronomic and geodetic points having been established and the adjacent shores and landmarks

charted, Hassler was ready to sound the waters. The schooner *Experiment* was the first of a long line of survey ships to sail back and forth across the sea, sounding by cast of the lead, and fixing position by three-point fix controlled by sextant cuts on the survey signals ashore. She did not last long, but she was joined, before her retirement two years later, by the brig *Washington*, a former revenue cutter and very clumsy vessel which did her work very slowly but well enough. The *Washington* displayed her sturdiness by surviving one of the most dramatic storm disasters in American maritime history. Contrasted with the efficient hydrographic ships of today, those labors were primitive indeed! They represented to Hassler, however, and to an impatient Congress, the first fruits of his work.

Among the first visible benefits was the finding of numerous rocks and ledges, hitherto unknown, in Long Island Sound. Singularly striking was the discovery by Lt. T. R. Gedney, on assignment from the Navy, of a deep channel approaching New York from the southeast, passing near Sandy Hook. This had the utmost navigational importance. It was realized that, had Gedney Channel been known in 1778, a surreptitious entry of the friendly French fleet might have been effected with disastrous results for the British vessels within. Hassler had the satisfaction, before his death in 1843, of seeing the first surveys done from Point Judith to Cape Henlopen—some 9,000 square miles of charted area containing 1,600 miles of shorelines.

Hassler may have been as consecrated a public servant as ever lived. No one could doubt it who saw him as he sat night after night in his office, after midnight at a table lit by candles, checking computations, verifying map sheets of soundings, or writing his reports. He was doing work for which his meager appropriations did not provide workers, and he was seeing personally to the attainment of his own impeccable standards. When he could spare himself from his office or from the incessant demands of Congress for explanations and justifications, he endured the hardships of field life. It was on such an occasion in 1843 that, during a storm, he fell in the dark trying to protect one of his cherished instruments from the elements, injuring himself upon a pointed rock and subjecting himself to exposure. Aged 73 years and weakened by a lifetime of relentless work, he died in pursuit of his vision, probably little realizing how enduring his example was to be.

The Bureau grew rapidly in size and in the strength of its organization under Hassler's successor, Alexander Dallas Bache, who served until 1867. One of America's all-time great educators and scientists, this great-grandson of Benjamin Franklin had intellectual curiosity, progressiveness, organizing ability, and personal charm.

Having graduated with high honors from West Point, he was qualified in military science. He found time to design the military defenses of Philadelphia, while directing the Coast Survey participation in the campaigns of the Civil War. He was one of the founders and the first president of the National Academy of Sciences.

Bache fell heir to the entire Atlantic and Gulf coasts, soon to be augmented by the admission of Texas in 1848, and California soon after. He divided the area into districts, speeding the work at once in all parts and presenting a picture of progress favorable for political appraisal. This required the development of a strong corps of assistants.

Lt. Cdr. W. P. McArthur began hydrographic surveys in California with the USS *Ewing* even before the gold rush. In 1849 he started work at San Francisco to meet the influx of traffic, only to be interrupted by a mutiny of the gold-crazed crew—the only mutiny in Survey history.²

McArthur was responsible for the selection of the Mare Island site for the famous naval base. His pioneering work in the West, continued by a line of outstanding descendants, has left his name permanently known in the Pacific Northwest.

Assistant George Davidson, veritably the father of science in California, went west in 1850 to start geodetic and topographic work related to the hydrography of McArthur and others, and he spent most of the next 50 years in that new land. A tireless worker in various fields, he surveyed much of the western coast, investigated tidal and hydraulic problems, operated an astronomic observatory, wrote geographical notes and compendiums, organized the California Academy of Sciences, and taught in the university. He induced an eccentric millionaire, James Lick, to endow one of the world's great astronomical observatories. Davidson, and later Assistant W. H. Dall, made reconnaissance surveys and wrote coast pilot notes necessary to the opening to navigation of the dangerous waters of the Northwest and Alaska. Davidson's first pilot notes of the west coast appeared in California newspapers as early as 1848—far ahead of the first official Coast Pilots of the Bureau, which began in 1875 with a book on the Gulf of Maine.

Bache had the responsibility of guiding the Civil War operations of the Bureau. These were of many kinds, confirming earlier ideas regarding the potential military value of the work, particularly in coast defense problems. Almost countless campaigns found their progress dependent on technical services rendered by Coast Survey men. They worked at New Orleans and Vicksburg, at Lookout

² See *The Ewing* mutiny, by Thornton Emmons and Homer C. Votaw in U. S. Naval Institute Proceedings, January 1956.

Mountain and Chickamauga, in the Shenandoah Valley and on Sherman's march. The naval victory at Port Royal, possibly of decisive effect on the course of the war, was partly the result of reconnaissance, piloting, and mine laying by Assistant C. O. Boutelle, Lt. Cdr. C. H. Davis, and others.

In later wars the diverse skills of the Survey contributed to operations in all theaters. World War II, with its numerous amphibious operations, presented especially difficult requirements for surreptitious beachhead surveys, often made at night by Survey officers on military assignment, for the study and prediction of tidal regimes, and for the emergency charting of perilous waters in the little-known island groups.

Very early in the time of Bache, the slow speeds and unwieldy properties of sailing vessels led to the trial of steamers. The first of these, the *Bibb*, began work in 1847, after tests by then Lt. C. H. Davis, who later became a Rear Admiral and Superintendent of the Naval Observatory. His tests of the *Bibb* signaled the change from sail to steam, perhaps the greatest of the early technological advances in hydrography.

Major ships of the Survey today displace two or three thousand tons, and they are built to be fairly wide and steady, for much launch handling is necessary for the survey of inshore areas. Speeds are moderate, but the complex of electronic instruments devoted to survey operations is impressive. There are at present four such ships in the Survey fleet, with two more authorized. In addition, tenders of all sizes capable of maintaining themselves at sea are used in intermediate areas too exposed for launches but too close in for major ships. All, ships and launches alike, work with sonic gear permitting rapid and comprehensive scanning of the sea-bottom features. All, moreover, but the launches, are capable of working with radar, shoran, and the Survey's electronic position indicator system, known as EPI. It is hard now to find a quartermaster fully skilled in the ancient art of heaving the lead!

The growth of hydrographic work during and after the time of Bache saw continuous improvements and inventions of equipment and methods. Lt. George Stellwagen, operating on Georges Bank, invented a bottom sampler, while Louis Agassiz made studies of Florida coral reef growth especially for the Survey. Lt. Matthew F. Maury, the great oceanographer of the Navy and long Superintendent of the Depot of Charts and Instruments, though not officially assigned to the Survey, worked in such close association that he was naturally identified with it. He originated the use of wire in place of hemp for deep-sea soundings, vastly improving accuracy and speed. Registering deep-sea thermometers and water samplers were invented.

Lt. John E. Pillsbury, who became a Rear Admiral after distinguished service in the Spanish War, spent many years in the Survey, advancing the techniques of deep-sea exploration and inventing a direction-indicating current meter of great value. Surface current observations carried out by tracking marked bottles led to the intensive study of the Gulf Stream in 1848 and since.

Among the many outstanding later developments in oceanographic instrumentation were those of Comdr. C. D. Sigsbee, later a Rear Admiral, whose name is immortal for his contributions to deep-sea exploration. He commanded the *Blake* in the Gulf of Mexico in 1875-77, where he adapted Sir William Thomson's sounding machine to deep work, in part by the addition of a registering sheave to indicate the length of wire paid out. He also invented a water cup to bring up samples from several depths at one haul, and a collection trap for biological samples. In addition to these effective means of perpetuating his memory, he later commanded the *Maine* when she was lost at Havana.

In the early twentieth century, Nicholas Heck and others developed the wire drag, following the wrecking of the cruiser *Brooklyn* on a pinnacle rock at New Bedford. This method, an improvement on earlier clumsy pipe sweeping devices, has been widely used to sweep the passages of rocky coasts to disclose hidden dangers, such as the famous "Washington Monument Rock" which rises to within a few feet of the surface from general depths of 650 feet in southeast Alaska.

A relatively recent development is the fathometer, brought into useful form by the Submarine Signal Company with the help of the Survey. Its value is beyond reckoning. Another was the radio-acoustic ranging system, used for many years as a distance-measurement device until superseded by electronic position-finding methods. Radio-acoustic ranging used the transmission times of underwater sound signals. In the course of development work in this field, Comdr. O. W. Swainson and Dr. Karl Dyk, working off the California coast on the *Pioneer* in the early 1930's, discovered and explained a striking phenomenon, earlier predicted by A. L. Shalowitz, which later led to the operational use of SOFAR, a signaling device. Sound signals travel great distances when directed into certain minimum-velocity layers, constituting effective sound-conducting channels. Vast areas of offshore hydrography, controlled by the radio-acoustic ranging method, have benefited by this fortunate circumstance.

Charts in Hassler's time were laboriously prepared by engraving myriads of details on stone or copper plates, from which impressions were made by hand. The first one of all, showing Newark Bay, was printed from the stone, which gave poorer definition than copper. In 1844 the first copper-plate engraving, of New York Harbor, was

prepared. In 1850, processes had been so speeded that the first sheets from the west coast resulted as published charts within 20 days. The Bureau gradually assembled a large group of skillful men whose artistry resulted in some of the most beautiful chart engravings ever seen. This craft endured until recent years, to be supplanted at last by newer methods of glass-negative engraving and photolithography, developed largely in the Survey in the unromantic cause of efficiency.

The first years of chart production saw perhaps 4,000 copies produced in a year. These were all nautical charts. With the advent of aviation and the sudden great growth of air navigation, the bureau had thrust upon it a duty of supplying aeronautical charts as well, a duty which multiplied the cartographic and printing work many times. A vast number of general aeronautical charts have been required—World Aeronautical Charts, regional, sectional, and route charts—as well as special facility and airport approach and landing charts. The multicolor presses of today have delivered more than 43 million nautical and aeronautical charts in a year, many of them printed cooperatively to augment the reproduction facilities of the Hydrographic Office and other Federal chart agencies. The development of the crude chart of olden times into a highly specialized instrument of navigation has involved a long series of changes, simplification, and adaptation. Chart use is now complicated by the requirements of high-speed navigation, radio, and radar techniques, and other new practices not dreamed of in the early nineteenth century.

Sea-level studies, the handmaiden to hydrographic surveys, have had to be carried on. Tide gages were widely distributed and the analysis of tidal regimes begun in 1853, permitting the publication of tide predictions for use in ship operations. Assistant Joseph Saxton invented an automatic-recording tide gage. Basic hydrodynamic theories of tidal motion were later developed by Assistant William Ferrell and elaborated by mathematician Rollin Harris. They brought weird notions of the ocean pulse into systematic order. Harris and Fischer built a tide-predicting machine capable of integrating the phases of 37 separate harmonic components into the complex tidal curve. These activities earned the Survey the primary responsibility in the United States for tidal investigations, and the publication of worldwide tide and tidal-current predictions is now effected by the Survey, in cooperation with the Navy, which has the basic responsibility for the foreign-area work in this field.

The laborious chaining method of surveying shore areas and landmarks necessary in coasting and piloting has gradually given way to the planetable and stadia rod, to photography, and finally to air photogrammetry, which quickly and accurately provides the information needed for the compilation of detailed topographic maps.

Capt. O. S. Reading, a recently retired photogrammetrist of the Survey, developed a 9-lens mapping camera particularly adapted to the survey of coastal areas. From a height of 14,000 feet, it can snap all the details in 121 square miles of land—a tremendous aid in the incidental problem of shore mapping, notwithstanding the intricate processes of photointerpretation, rectification, and compilation.

The 1,200 triangulation stations originally laid down by Hassler were forerunners of a vast structure of geodetic control surveys of the utmost importance in all areas of engineering and natural-resource development. Bache started the eastern oblique arc of primary triangulation destined eventually to reach from the Bay of Fundy to New Orleans. This, and the later great transcontinental arc across 2,500 miles of varied terrain from coast to coast, have figured in scientifically important investigations into the most basic and fundamental properties of the earth itself.

Widespread improvements in the fieldwork methods of astronomy and geodesy have been highlighted by such dramatic innovations as the use of the electric telegraph in 1848 for the determination of longitude between land stations, and Bache's apparatus for measuring a 7-mile baseline with an uncertainty of only one inch. Baseline work, first done with iced measuring bars placed end to end, later employed tapes made of metals that do not change length with varying temperature. Such improvements culminated in the precision that permitted the triangulation of the distance between two California mountain peaks used by Michelson in his classic determination of the speed of light—a distance fixed with a residual probable error of less than one part in five million. Geodetic survey work has seen innumerable smaller improvements, including light and portable theodolites, heliotropes, and electric signal lamps to pinpoint signal points at great distances, and the Bilby steel towers, portable and far faster to use than wooden ones, for the elevation of instruments above surrounding objects. New methods of distance measurement directly by radio or light-beam methods are under test now and provide possibilities of superseding time-honored methods of triangulation.

As a necessary corollary to the involved reductions of geodetic computations, gravity investigations were started in 1875, using Bessel pendulums, later supplanted by temperature-insensitive invar pendulums and the present improved apparatus. Such investigations led to earth-crustal studies by later geodesists John Hayford and William Bowie, who became authors of the fundamental theory of isostasy upon which modern notions of mountain building and other tectonic processes are based. Capt. Bowie, one of the outstanding modern scientists of the Survey, was a strong advocate of comprehensive national mapping programs. He had much to do with

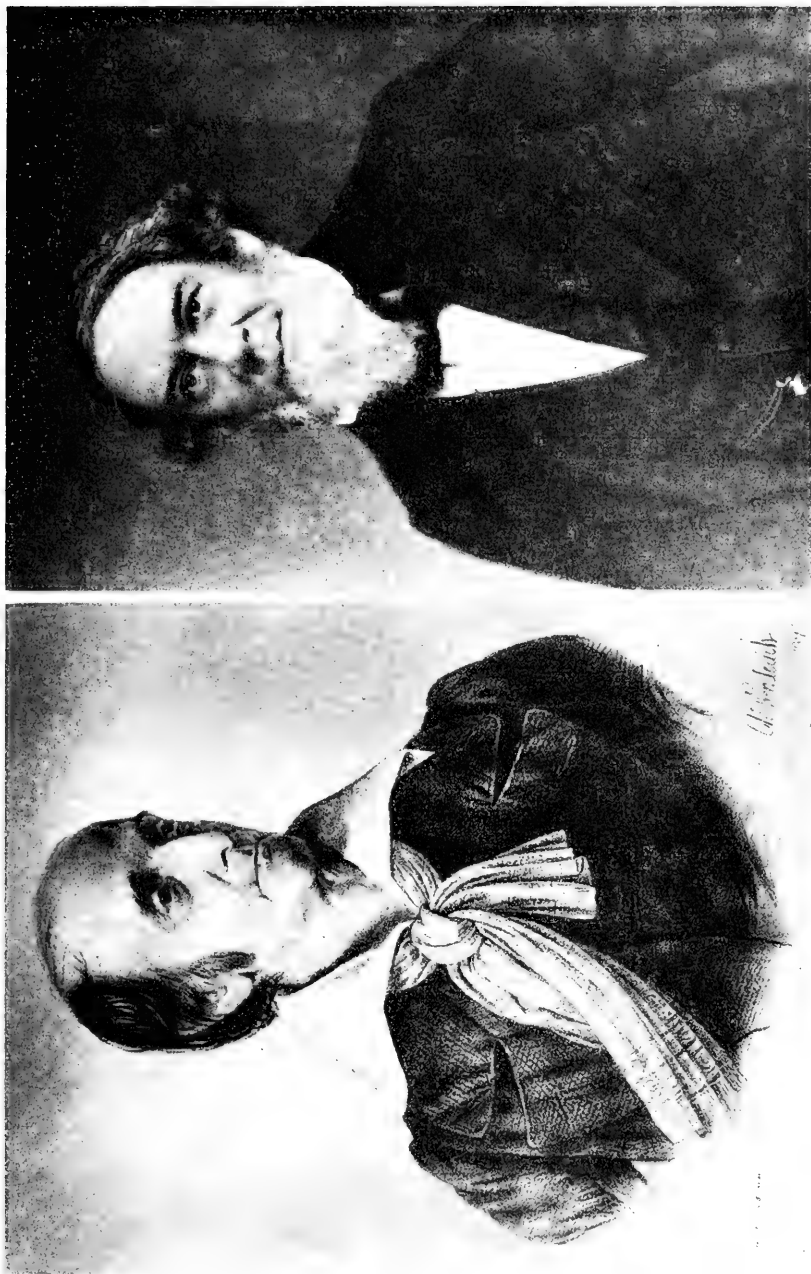

Ferdinand R. Hassler (left) and Alexander D. Bache. The Swiss-born scientist and perfectionist, Hassler, was the first Coast Survey Superintendent. He set the high standards maintained, despite the great growth of the bureau, by his successor, Bache, a great-grandson of Benjamin Franklin and Superintendent from 1843 to 1867.

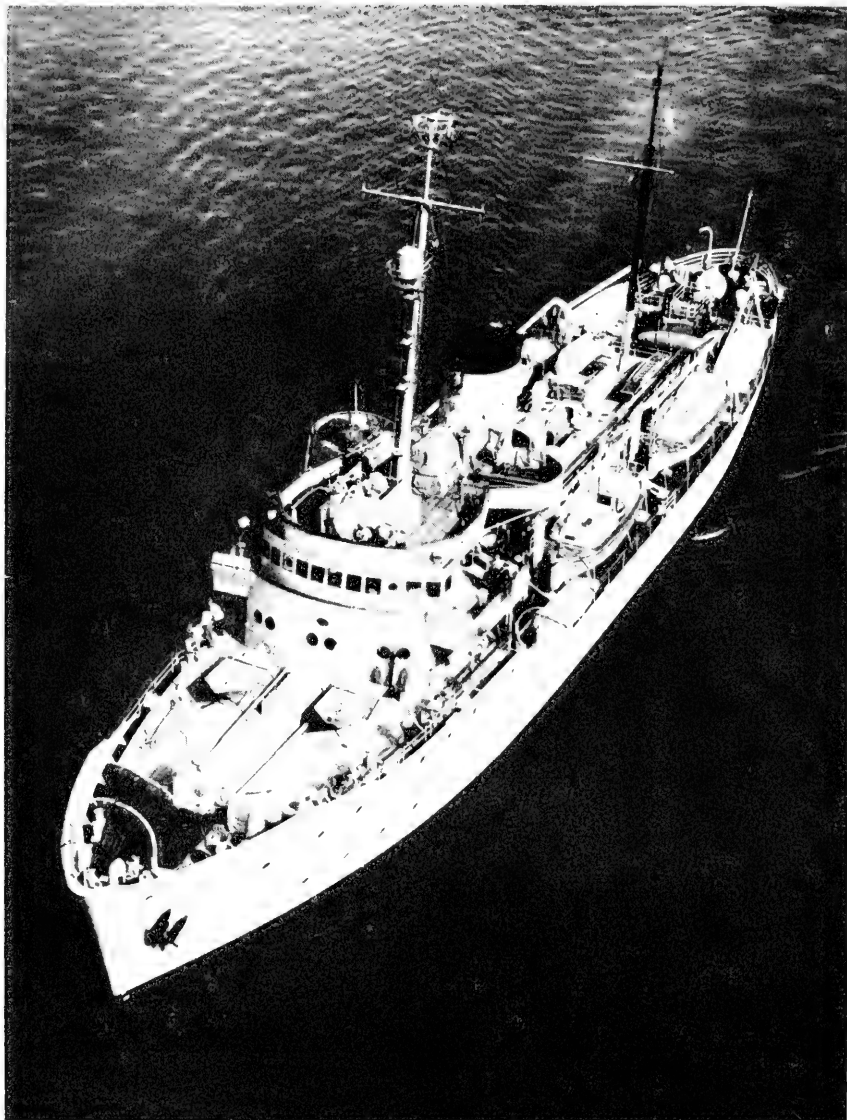

The *Explorer*, one of the four modern survey ships now in use, was built in 1940 for Alaskan Survey work. She displaces 1,900 tons and has a cruising radius of 6,000 miles at 15 knots.



1. Solving an Alaskan transportation problem. The helicopter will take off from the base camp with the small boat for work in obscure waterways.



2. A "cat-train" bound for survey operations near Point Barrow. Long hitches of sleds and "wainigans" carry the surveyors, their instruments, and their habitation as a relatively self-sustained unit.



1. Baseline measurement for the triangulation network.



2. A level line party working near Fort Peck, Mont.

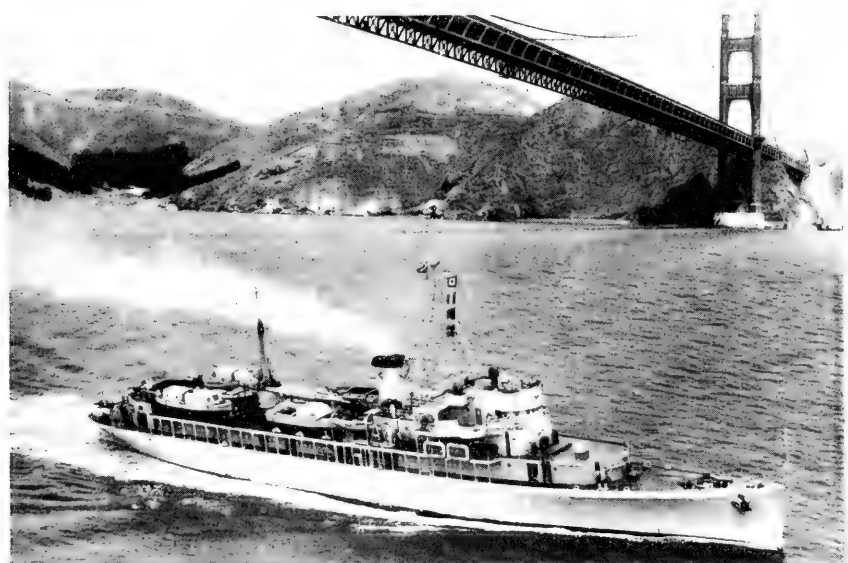

Ships that have served in the Coast and Geodetic Survey. Upper, the *Pathfinder* (ex-AGS-1) followed by the *Explorer*, the *Surveyor*, and, barely discernible at the far right the tender *Derickson*. Lower, the *Pioneer* (ex-*Mobjack*).

the establishment of coordinate systems designed to bring the benefits of geodetic control to all surveyors. He was also the architect of the existing 1927 North American geodetic datum, which resulted from one of the greatest mathematical feats of general adjustment in the history of geodesy.

Benjamin Peirce, one of the foremost mathematicians of the country and also a Superintendent of the Survey, employed his son Charles, who worked several years before going on to become a world-famous philosopher and author of the theory of pragmatism. Bureau mathematicians, trained to recognize faultless observations, were called on to examine the questioned North Pole observations of former Survey draftsman Robert Peary. These, as the world knows, were found beyond possibility of falsification, closing the controversy by a simple demonstration of the truth, and paving the way to his receiving the rank of Rear Admiral from a grateful Congress.

Later officers have served as special experts and adjudicators in numerous trials over riparian rights, waterfront land grants, and other beach problems. Some such cases have involved millions of dollars, and one concerned the actual ownership of parts of the naval base at Mare Island. Today such special knowledge is in demand in cases of offshore rights involving the troublesome problems and definitions of seaward boundaries.

Plans initiated by Hassler and carried forward by Bache and his successors to investigate the elusive and little-understood magnetic forces that actuate the compass needle have led the Survey to the operation of several fixed observatories, where instruments of great sensitivity make continuous recordings of the fluctuating magnetism. They provide the magnetic information necessary to the use of magnetic compasses in navigation, thus serving all ships and aircraft. They help monitor radio communication conditions, use of radio navigational aids, and the prediction of radio fadeouts. They provide basic information for the interpretation of magnetic prospecting surveys made in the search for oil and minerals, as well as for the use of military implements.

The first isogonic chart was published in 1855, partly as a result of the use of a magnetometer of Bache's design. The Survey has now been legally designated as the nation's collection agency and repository for world magnetic data, and it compiles all American-issue magnetic charts, including world charts prepared for publication by the Hydrographic Office.

Experience in the exacting task of operating magnetic observatories led to an assignment of like nature in 1925, when the responsibility for seismological investigations was added. This called for similar skills and took advantage of the existence of the observa-

tories, excellent places to operate seismographs. The Survey therefore detects, locates, and studies earthquakes for scientific purposes, as well as for practical ends having to do with engineering precautions, public safety, and insurance rates.

The interest and observational skill of the Bureau in geodesy, geomagnetism, seismology, and some aspects of physical oceanography have led to its selection as the operating agency for substantial portions of the United States program for the International Geophysical Year of 1957-58. Field activities of this program will augment those of many other countries joined together for worldwide cooperation in this event, as in the previous two International Polar Years of 1882-83 and 1932-33, which provided important scientific advances in geophysics.

The discovery of gold in Alaska in 1882, and the later Klondike gold rush of 1897, speeded the northern work and started a long and still unfinished story of charting in that remote, austere land. All later Survey officers have had their share of battling what have often seemed to be hopeless odds of weather and terrain. The waters of Alaska, infinitely complicated and strewn almost everywhere with rocks rising out of the depths, have nevertheless great importance in the development of the territorial resources of fish and minerals. Almost unbelievably dismal, and torn by some of the world's worst weather, the seas and waterways of the territory are nevertheless exquisitely beautiful at times. Every man who has put in his time sounding its channels, surveying its craggy shores, or tracing boundaries through the muskeg must count it a highlight of his life. The peaks, bays, headlands, and glaciers bear the names of Dall, Mendenhall, Faris, and many other Survey field men. Literally hundreds of places have names betraying the visits of the famous steam launch *Cosmos* and other survey vessels that spent their years in those waters.

Much the same can be said of the other great overseas undertaking of the Survey, involving the provision of modern charts for the 7,000 islands of the Philippines. Beginning in 1901, this became a routine part of every Survey career—an interlude spent in a tropical wonderland where the weather was almost always good, the scenery lush and beautiful, and where experience was gained apace, despite certain drawbacks of local insurrections, unfriendly natives, tropical heat with pests and fever, and typhoons. Starting from nothing, a basic modern survey was made in 40 years, and a skilled hydrographic and geodetic service developed in time to be handed over to the new government of the Republic after World War II.

When Hassler died in 1843 it is probable that he little realized how enduring his example would be. On this 150th anniversary of his bureau, the realization becomes vivid indeed!

Cosmic Rays from the Sun¹

By THOMAS GOLD

*Professor of Astronomy
Harvard University*

[With one plate]

COSMIC radiation is a phenomenon that has been of the greatest consequence to the development of modern science. Nature provided us there with an incessant stream of very fast and very energetic particles which come into the atmosphere from outer space and which could be put to excellent use. Many of the important discoveries of nuclear physics were made with them, and they have given many times a foretaste of the work that could be done with the great machines the cyclotrons and synchrotrons for which quite properly many millions of dollars are now being spent.

This stream, as we know now, consists chiefly of protons, the nuclei of hydrogen, which arrive with energies as if they had been subjected to electrical acceleration by a machine giving from 1 billion to 1 billion billion volts. The lower range of energy can just now be matched by the synchrotrons, while the upper energies are very far outside the capabilities of any technical device which we can at present contemplate. Although the universe is large and contains many localities that we are still quite ignorant of, it is very difficult to suggest where and how gigantic natural machines of the sort could be at work. This problem is in fact such a great one that one has from time to time wondered whether there is some great gap in our basic understanding of Nature and whether the cosmic rays are perhaps the result of some fundamental process of which we are quite unaware. The alternative is to find within the known fabric of astronomy places and situations where gigantic natural accelerating machines could be at work. The sun has greatly helped us with this. It has demonstrated beyond any doubt that it can make a contribution to this stream of high-energy particles on some occasions. The sun is a steady star, and we are no

¹ Twenty-fourth James Arthur Lecture on the Sun, given under the auspices of the Smithsonian Institution on April 10, 1957.

doubt very glad of its steadiness. But in its outer layers there occur phenomena of very great violence—a kind of meteorology where the scale and the speeds are enormous compared with those on the earth and where the forces responsible are evidently of quite a different nature. One particular phase of this atmospheric violence is called a flare. It is not known what gives the phenomenon its great suddenness and its terrific power, but it is certain that electric forces play a very large part. Speeded-up movies of motions in the sun's atmosphere are taken at the high-altitude observations at Climax, Colo., and at Sacramento Peak and in those one can see the powerful guiding effects that are undoubtedly magnetic. Basically, though not in detail, it is understood how magnetic fields would guide the motions of gases and it is known independently from optical observations that very strong magnetic fields occur in the vicinity of sunspots which are also localities of the greatest visible disturbances.

Flares are seen by the great increase of the light in some parts of the spectrum. In a matter of a few minutes some region in the sun's atmosphere lights up in bright emission-line light, and in the case of the most intense flares a big and interesting chain of events is then initiated. It is a more or less fortuitous circumstance that we do not often take notice of the great flares without the use of instrumentation. Almost all the great effects of a flare are in forms that either do not penetrate through the atmosphere of the earth, or that we cannot perceive by our own sense organs. For this reason it is not easily appreciated just how terrific an event a great flare is. The first effects that arrive at the earth are usually intense radio noise that can readily be received on modern radioastronomical equipment, and the ultraviolet light that does not penetrate the atmosphere but results in characteristic effects in the upper layers where it is absorbed. Sudden interruption of all long-distance radio communication may set in on the entire day side of the earth. Also the sudden change in the electrical properties of the upper atmosphere gives rise to slight but immediate disturbances in the earth's magnetic field. A day or two later a great magnetic disturbance may set in, being no doubt due to some ejected gas having then reached the earth from the sun.

All these effects have been known for a long time, and many parts of the phenomena have been explained, but the basic effect that happens so suddenly and with such violence on the sun is still not understood, although of course there are a number of theories.

As a result of the work of Forbush and Ehmert, it has become known that another type of event is related to flares. The rate of bombardment of the earth by cosmic rays shows occasionally a sharp increase clearly related to the very greatest of the solar outbursts. Since 1942 only five such events have been detected. But strangely

enough, although the effect is very rare, when it occurs it does not seem to be of a marginal nature. All five events are easily detectable and substantially smaller events would have been observed had they occurred. The rarity of the phenomenon is thus not to be thought of as due to very few only having reached a detectable level.

These events have made it clear that a particle accelerator can occur in the atmosphere of the sun and hence presumably also in a great number of other stars. So one might think that here is the clue to the entire process. Cosmic rays are perhaps all made in the atmospheres of stars. After all, there are many stars on which we might well suppose that far more violent effects are taking place than on the sun. Could they not supply the entire stream? Some people think so, but there are serious difficulties in this. The sun's cosmic rays when they occur are all among the lowest energy particles that can reach us on the earth's surface. In the general flux there is a much greater proportion of high-energy particles. And, after all, the difference between the low- and the high-energy particles is really great. Their impacts are about as different as being hit by a fly or a truck. There are no stars where we could really suppose the high-energy particles to be accelerated. Presumably then, there must be mechanisms operating on a larger scale than the stars. The solar process is the one that we really know something about now, and we can watch. We hope that it will show us a basic mechanism, and there is, of course, the hope that a similar mechanism will in different circumstances be found in other places. Accordingly one is hard at work trying to understand ways in which these magnetically controlled hurricanes and typhoons on the sun's surface can produce the accelerated particles. Perhaps I should mention one interesting hint that we have.

In Russia, and here too I presume, people have made experiments with very strong electric sparks in the hope of reaching temperatures at which the great energy-generating process of nuclear fusion will set in. One curious and quite unexpected byproduct of these sparks has been the generation of fast particles accelerated to much higher energy than could be accounted for by the voltage that had been applied altogether. So there, in front of our eyes, nature is performing such a trick as using in some way the violence of a spark to accelerate a very tiny fraction of the gas molecules present to enormous speeds. It may well be that the same trick is done also on the sun and perhaps in larger regions still. Experimental research and the observations of the solar phenomena may together give the answer.

The best information that we have about the details of the solar cosmic-ray production comes from the great event of February 22-23,

1956. There occurred then a very large flare just near the edge of the sun. It was seen in Japan and India (not here, as it was the middle of the night) and it was recognized by the Japanese observers as a most spectacular event before they knew of any of its other effects. The flare was so bright that it could be seen without the usual spectral filters, just as a bright spot on the sun's surface. Beyond the nearby edge they reported seeing a bright fan-shaped structure and nothing like this has ever been seen before. The radio-noise observations indicated a major outburst and one that was extraordinary in that the disturbance seems to have reached a very great height in the solar corona. There was a complete fadeout of high-frequency radio communication over the sunlit side of the earth and there was the characteristic magnetic effect that indicates when very intense ultraviolet light has struck the outer atmosphere of the earth. All this was the common pattern of events, just very intense. But about 15 minutes after the beginning, the cosmic-ray rate suddenly began the sharpest increase and then reached the highest level that has ever been known. This occurred all over the earth, not only on the side facing the sun. The reason for this is, of course, that cosmic rays are charged particles and are therefore deflected by the earth's magnetic field to get right around to the back. After a further 15 minutes, the peak was reached and its intensity was such that about two hundred times the usual number of cosmic-ray particles hit the earth every second. The rate then decreased, but much more gently than it had risen. After a few hours it returned nearly to normal.

In a world that is very conscious of radiation disease, one should explain that this does not constitute a serious attack on us. The total amount of radiation that every person received in those few hours was still very much less than we take in during an X-ray examination. On the other hand, if the sun were ever to decide to continue this kind of stream on a steady basis, it would undoubtedly be very harmful to us. But we can take it that this is not very likely, judging alone from the good continuity of biological development that seems to have happened in long periods on the earth.

I am reminded just how striking an event this was when I think of all the trouble to which we went to check the recording equipment before believing its answers. That morning I came in to work and my assistant was eagerly awaiting to tell me that during the night this enormous increase had taken place. He was used to looking for changes of $\frac{1}{2}$ percent or so, and there was a change of over 100 percent recorded. Everything was tested before we dared to announce this as real; and then a little later all the other reports of the event started to come in. In all, some 40 cosmic-ray recording stations all over the world produced useful records, including, of course, the two

important chains of stations—one belonging to the Carnegie Institution and run by Dr. Forbush, and the other by Dr. Simpson of the University of Chicago. The great number of stations around the globe is important if one wishes to infer the directions of the particles before they entered the earth's deflecting magnetic field.

There occurred another new phenomenon on this occasion. The cosmic-ray stream was so intense that it changed the electrical properties of the upper atmosphere in a way that had never happened before. Even on the night side of the earth low-frequency radio communication was severely affected, and in high-latitude regions most or all radio contact ceased. This was presumably the effect which caused the British Admiralty to announce that it had lost contact with a submarine in arctic waters, and had ordered a search. The submarine was in fact quite all right, and was probably baffled also by the absence of a reply from the Admiralty.

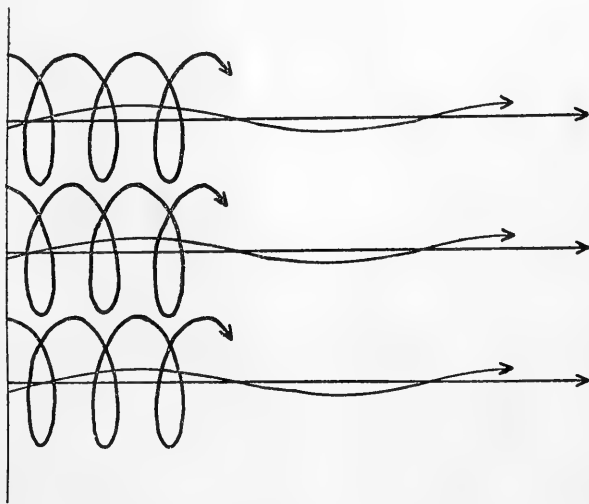

FIGURE 1.—Diagram illustrating how particles that embarked on spiral orbits of different pitch will be delayed differently and why late arrivals will appear to come from a variety of directions different from the main direction. The size of the earth is small compared with the radius of the spirals.

This cosmic-ray outburst not only is an interesting event but also it can be used to tell us something of the condition of the tenuous gas that fills space between the sun and us. For a number of years now, physicists and astronomers have been discussing the reasons why they supposed very extended magnetic fields to be carried by all the very tenuous gases in the galaxy and of course also by the somewhat denser gases of the solar system. But there has not been any other observation that was so clear cut in indicating these fields. Here we saw that particles that had almost certainly started their

journey at the sun arrived in the vicinity of the earth at first in the direction from the sun—that is, after one takes into account the local effects of the earth's magnetism—but later on during the decline they arrived quite certainly from other directions. Now there is no other effect that could have deflected these fast particles from a straight-line path except suitable magnetic fields in the space of the solar system.

What are the shapes of such magnetic fields? How can one account for the curious fact that the stream can evidently reach here in the first place without deflection, but that the latecomers get deflected? This and a number of other effects are at the present time under discussion. Naturally one wants to learn as much as possible about the conditions in the solar system before one can go up and have a look.

I have been discussing these problems with colleagues at Cornell University, and with Dr. Hayakawa from Japan, and we conclude that the effects would be reproduced if we supposed that the outer corona of the sun extended to the earth, and that it retained the streamerlike appearance. We therefore considered the propagation of cosmic-ray particles along very elongated "streamers" of magnetic field. The particles will then spiral around the direction of the field, and the ones that were accidentally emitted just in the direction will be the first to arrive; the ones that started at an angle will take a longer path and hence arrive later. The last to arrive will then be those that started in extremely flat spirals, and those will then appear to arrive at the earth from directions other than that to the sun. Now this was just what happened. On this basis we then calculate the way in which the intensity would rise and fall, owing to the delay effect of the spirals, and the agreement is good. There are still some points that need further explanation, but I feel sure that we are here learning something about the conditions in the solar system.

Much of the difficulty of the discussion would be removed if only the sun were kind enough to give us another event of this sort. I am certainly hoping for one. But perhaps one day this sort of thing will be regarded as one of the hazards of space flight, for without the protection of the thick atmosphere these effects may be quite unhealthy. Then we shall be glad that they are so rare.

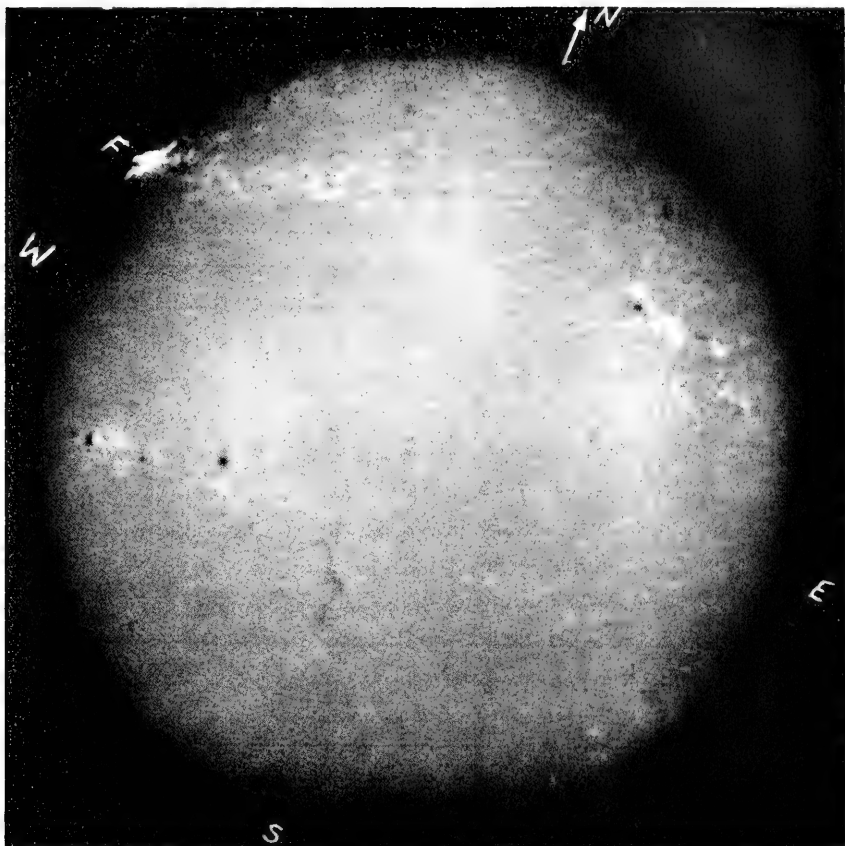

The sun in $H\alpha$ light showing the great flare of February 23, 1956. Photograph courtesy of Kodaikanal Observatory, India.

Meteors¹

By FRED L. WHIPPLE

*Smithsonian Astrophysical Observatory
and
Harvard College Observatory*

[With six plates]

SOLID BODIES from space continuously bombard the earth at a rate of thousands of tons per day. Fortunately for the life forms on the earth, the earth's atmosphere serves as an admirable buffer to protect them from this constant astronomical shellfire.

The slowest meteorites strike at a speed of 7.0 miles per second, the speed with which the earth attracts particles that fall from rest at great distances. The speed of faster ones depends upon their origin and direction of motion. Bodies belonging to the solar system travel in closed orbits around the sun at velocities up to the parabolic limit of 26.3 miles per second at the earth's distance from the sun, while the earth itself moves about the sun at a speed of 18.5 miles per second. The highest velocity of impact occurs, of course, when one of these nearly parabolic particles strikes the earth head-on, so that the total velocity reaches a maximum of 45 miles per second.

Figure 1 shows how the collisions occur. The fastest meteorites tend to strike on the morning side of the earth and the slow ones catch up on the evening side.

These meteoritic projectiles vary in size from minute particles to very large ones, and are classed as follows: Meteoritic dust, telescopic and radio meteors, photographic and visual meteors, fireballs, detonating bolides, meteorite falls, and, finally, crater-producing meteorites.

Meteoritic dust (see Buddhue, 1950) ranges from barely visible specks down to microscopic objects, limits in size being set by the sun's ability to blow away particles about 1 micron (0.00004 inch) in

¹ Revision of an article in *Publ. Astron. Soc. Pacific*, vol. 67, pp. 367-386, 1955. Published by permission of the Society.

diameter. Micrometeorites are heated as they strike the earth's upper atmosphere, at an altitude from 130 to 100 km., but because of the small ratio of their mass to surface area, they can radiate away the heat of impact fast enough to prevent heating above the melting point of ordinary materials such as iron or silicates. Thus many of these particles, as has been shown by Öpik (1956) and the writer (Whipple, 1950, 1951), can reach the surface of the earth without being greatly damaged. The larger particles in coming through the atmosphere may be melted and fused into small globules by this process without losing much of their mass.

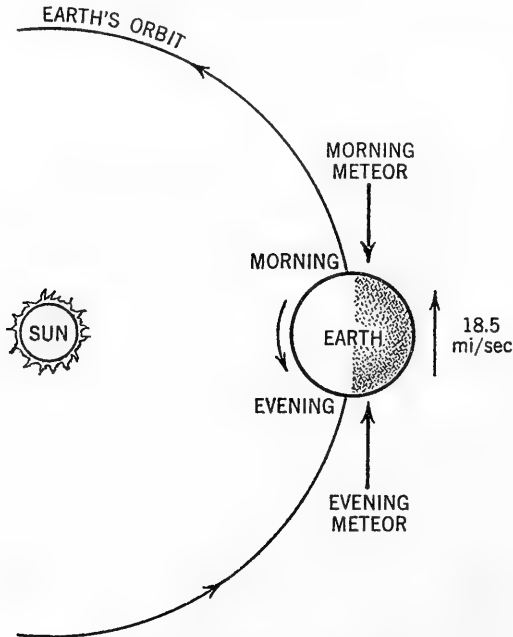

FIGURE 1.—Schematic diagram showing how meteorites collide with the earth.

Larger particles, perhaps the order of a thousandth of a gram or greater, produce enough light by friction with the earth's atmosphere to be visible as telescopic meteors and produce enough electrons to give radar echoes as radio meteors. Both the telescopic and radio techniques can, of course, be used to observe much brighter meteors, and the lower limit of their sensitivity is well below that of the naked eye. Meteors visible to the naked eye fall in the category of visual meteors; today the extremely sensitive Super-Schmidt meteor cameras in New Mexico can photograph nearly to the limit of naked-eye visibility.

On certain days of the year meteors occur in showers, when the earth happens to cross a stream of meteoric particles in space. All

the meteors in a shower strike our atmosphere in parallel paths so that all their trails, when extended backward on the sky, tend to meet in a point, or radiant (fig. 2). The shower is then named for the constellation in which the radiant appears. Some meteor streams are uniformly dense so that when the earth crosses their orbit we can always count on a good display—for example, the Perseid meteors

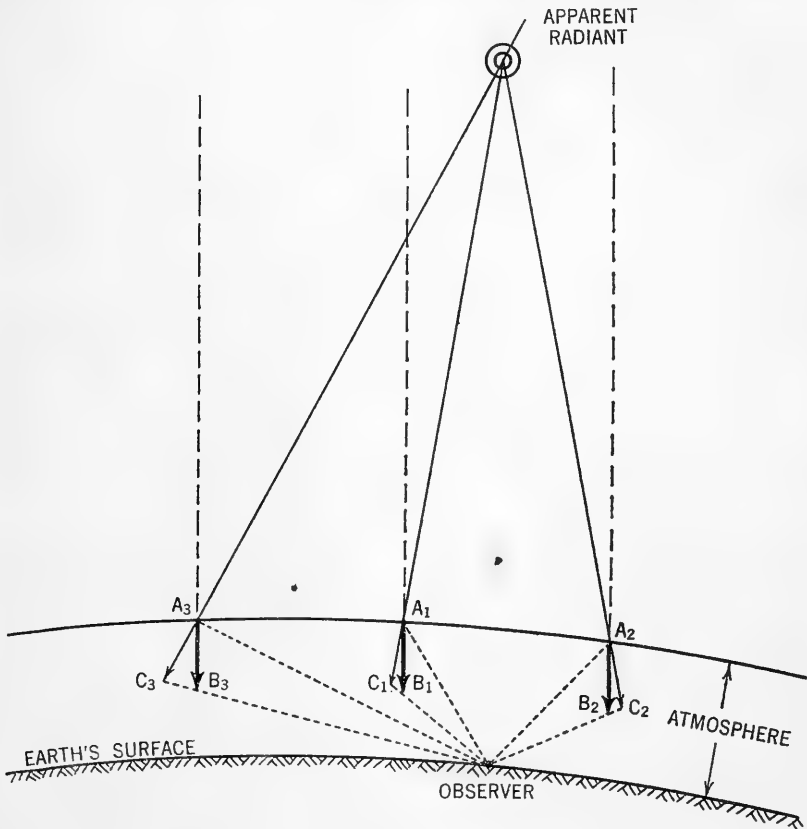

FIGURE 2.—Trails and radiant of a meteor shower. Above the atmosphere the parallel dashed lines show the real paths of the meteors A_1 , A_2 , and A_3 ; solid lines show their apparent paths. In the atmosphere the arrows AB show the real meteor paths, and the arrows AC show the paths as they appear to the observer.

from August 9–14, and many bright Geminid meteors on December 12–13. Occasionally, as on October 9, 1946, meteors seem to fall almost like rain, occurring as frequently as one a second.

As we consider larger and larger bodies we find that with increasing size they penetrate more deeply into the earth's atmosphere and appear as brighter and brighter meteors. If a meteor is bright enough to produce a flash of light that illuminates buildings at night or produces shadows, it is called a fireball. If it is accompanied by a de-

layed rumbling, caused by its breaking up in the lower atmosphere, it is called a detonating bolide. For these larger bodies the atmosphere is less effective as a shield, so that sizable pieces of these celestial cannonballs survive the atmospheric friction and fall to the ground. These fragments we call meteorites, which we collect and preserve in our museums as our only tangible samples of the great universe that exists beyond the earth's atmosphere. Perhaps we are fortunate that this sampling rate is so low; otherwise more of us would suffer the rare and undesirable experience of Mrs. Hodges in Alabama, who, on November 30, 1955, was injured when a meteorite penetrated her house and struck her on the hip.

The collection of meteorites in the Smithsonian Institution is one of the largest and most valuable in the world. These rare specimens are continuously used by scientists in their attempts not only to discover the origin and history of the meteorites themselves, but also to understand the general laws of supersonic ballistics involved in the meteor's course through the earth's atmosphere. (See pl. 1.)

For bodies even larger than the average meteorite, the earth's atmosphere finally ceases to be an effective barrier. Thus irons or stones weighing hundreds of tons or more are affected scarcely at all in falling through the earth's atmosphere. They plow into the ground at supersonic speeds and explode, to produce immense craters. These explosions are literally like those made by huge bombs because of the enormous kinetic energy of the meteorite. The extremely rapid motion endows each pound of the meteorite with much more energy than that contained in a pound of the most powerful chemical explosive. This energy is instantly released when the earth's surface stops the meteorite. A crater-forming meteorite of atomic-bomb energy fell in the general region of Vladivostok in 1947 and produced a great many craters over a large area of ground. In 1908 an even larger fall, of greater than H-bomb energy, occurred near Pultusk in Siberia. It leveled the trees radially from the point of impact for some 50 miles.

No huge craters have been formed by meteorites in historic times, but the great Barringer meteor crater in Arizona, now some 600 feet deep and nearly a mile across, represents the greatest of such celestial visitations in the United States (see Nininger, 1952). The largest meteorite crater in the world is probably the one in the New Quebec (Ungava) area in Canada and is nearly 3 miles in diameter. The crater is now an almost perfectly round bowl, partially filled with water to form a beautiful lake, standing unique in a great area of granite that was once covered by glaciers.

The geological evidence proves that even more powerful celestial bombing has been directed toward the earth in past geological periods

than these craters suggest. The Harvard geologist Daly (1947) gives convincing evidence that the great Vredefort dome in South Africa was once a meteorite crater some 50 miles in diameter. In the hundreds of millions of years since it was formed the crater has been filled by sediments, tilted over at a considerable angle, and its edge greatly eroded. Many astronomers suspect that such fossil craters on the earth are "blood relatives" to the great craters that we see on the moon. Baldwin (1949) has strongly supported this view in his book, and scientific evidence is accumulating to support his theory.

The great meteorite craters and the meteorites themselves present a myriad fascinating problems. Since I cannot do even summary justice to both meteorites and meteors I must regretfully abandon the former and discuss meteors alone in the remainder of this article. Before leaving the subject of meteorites, however, I must mention that the majority of meteoriticists favor the theory that many or most of the meteorites originated in two or (many?) more small or minor planets, which have mutually collided and broken up to form both the asteroids and the meteorites. A cometary origin, as we shall see, is indicated for most of the smaller bodies that produce the usual visual and subvisual meteors. Thus the sources of meteors and meteorites still constitute a major area of research.

For nearly a century, since Schiaparelli (1871) identified the Perseid meteor shower as being associated with the comet of 1862-III, astronomers have accepted a cometary origin for recurrent meteor streams. At the same time, most investigators have agreed that broken fragments of small planets must contribute to the sporadic meteors, those that do not appear in showers. There have, however, been great disagreement and much discussion as to whether some of the meteorites and some of the meteors may not be visitors from interstellar space rather than from our solar system. To distinguish interstellar from solar-system meteors we need only measure their speeds and trajectories through the atmosphere. After correcting for the resistance of the atmosphere, the rotation and attraction of the earth, and the earth's motion about the sun, we can calculate the meteor's original speed and its orbit about the sun. If the speed was less than 26.3 miles per second, the orbit was closed, i. e., elliptical, and the body belonged to the solar system. If the speed exceeded 26.3 miles per second, the orbit was open or hyperbolic, and the body came from out among the stars.

The visual methods, unfortunately, have not been adequate to settle this long-standing controversy over the origin of meteors. Even though extremely sensitive and quick in detecting faint fast-moving meteors, the eye is not an accurate measuring device for determining the precise geometry either of altitudes or of angular velocities across

the sky. Within recent years the photographic method has been developed to a high level of sensitivity with its natural accompaniment of extreme precision in the measurement of heights, trajectories, and velocities. Even more recently an entirely new technique, the measurement of radio reflections by radar methods, has become a vital tool in the study of meteors.

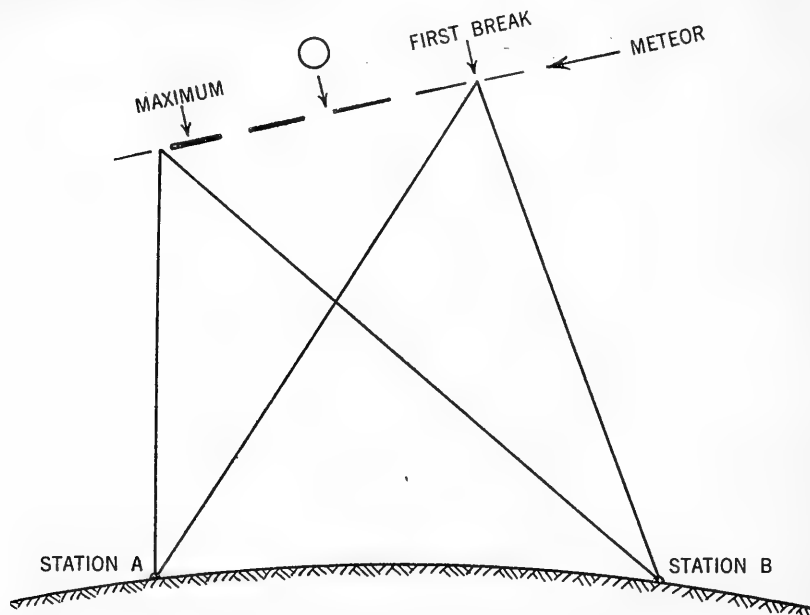

FIGURE 3.—Diagram showing a meteor photographed simultaneously from stations A and B; the circle represents a common point on both photographs of the trail.

Let us begin with the photographic techniques and follow them with a résumé of the radio techniques for studying meteors. The first long and systematic photographic meteor program was conducted by Elkin of Yale Observatory from 1893 to 1909 (see Olivier, 1937). He used two telescopes (fig. 3) and in front of each telescope he placed a rotating shutter and recorded its speed of rotation by means of a chronograph. Unfortunately, he used such a short base line, about 2 miles, that the geometry of most meteor trails was poorly determined, so that he could not obtain accurate heights, velocities, and trajectories of meteors. In 1936 the writer initiated a similar method (Whipple, 1938, 1940), making use of the two stations operated by the Harvard College Observatory in Cambridge, Mass., and at Harvard, Mass., about 24 miles apart. The small Harvard patrol cameras at these two stations simultaneously photographed approximately half a dozen bright meteors per year.

After World War II, meteors and related upper-atmospheric problems and supersonic ballistics became of such interest that the United States Naval Bureau of Ordnance supported an extensive

meteor program at the Harvard College Observatory. This support made possible the design and construction of special cameras. James G. Baker designed the Super-Schmidt meteor camera (see pl. 2) and the Perkin Elmer Corporation constructed six of these remarkable instruments, two for the Naval Bureau of Ordnance, two for the United States Air Force, and two for the Dominion Observatory of Canada. Four of these cameras have been operated in New Mexico for the past several years by the Harvard College Observatory, supported by the Office of Naval Research and the United States Air Force, while the work of reducing the data has also been supported by the United States Army, Office of Ordnance Research.

The Baker Super-Schmidt camera has the unique optical design shown in figure 4: the aperture is $12\frac{1}{4}$ inches and the focal length only 8 inches, which gives the amazingly fast focal ratio of $F/0.65$. The effective focal ratio, including the obstruction by the photographic film, is still $F/0.85$. Along with this remarkable speed the instrument has a field diameter of some 55° without the rotating shutter, reduced to 53° by the shutter, which is supported inside the second glass shell and which revolves only about an eighth of an inch away from the spherical surface of the film. The film itself constituted a considerable problem because the emulsion has to rest on a spherical surface with an accuracy of 0.0005 inch and with a radius of curvature of only 8 inches. A process of molding photographic film, suggested by the Eastman Kodak Co., has been developed at Harvard, so that various types of blue-sensitive and panchromatic emulsions can be satisfactorily heated and molded to this high curvature without serious fogging or appreciable changes in the sensitivity of the emulsion.

Plate 3 shows an example of a meteor doubly photographed with the Super-Schmidt meteor cameras at two stations. The breaks in the trails were introduced by the shutter, which revolves at the rate of 1,800 r. p. m. and cuts off the light for $\frac{3}{4}$ of each shutter cycle. During the open part of the cycle, which occurs each $\frac{1}{60}$ of a second, a segment of the meteor trail is photographed.

Without the shutter to reduce the over-all exposure time, on a moonless night in New Mexico we would be limited to only 2 to 3 minutes instead of the 8 to 12 minutes which we can now use effectively. Plate 4 shows a photograph of the Organ Mountains in the neighborhood of Las Cruces, N. Mex., made with a 2-second exposure at midnight, with full moon. The circle in the center of the photograph is produced by the supporting hole for the rotating shutter and not by the moon.

Since 1952, some 6,000 meteors have been doubly photographed by these cameras in New Mexico. The photographs provide a surprisingly large quantity of information about meteoric phenomena

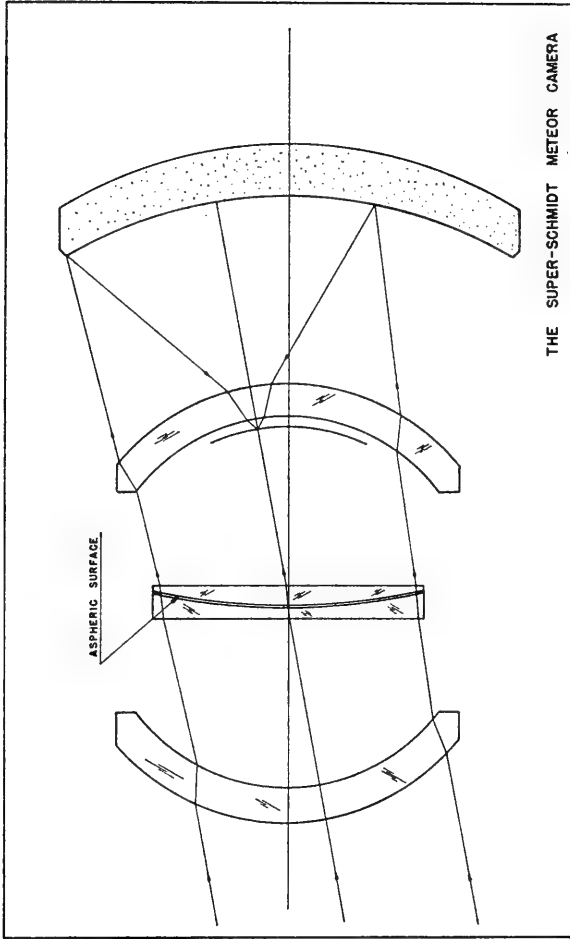
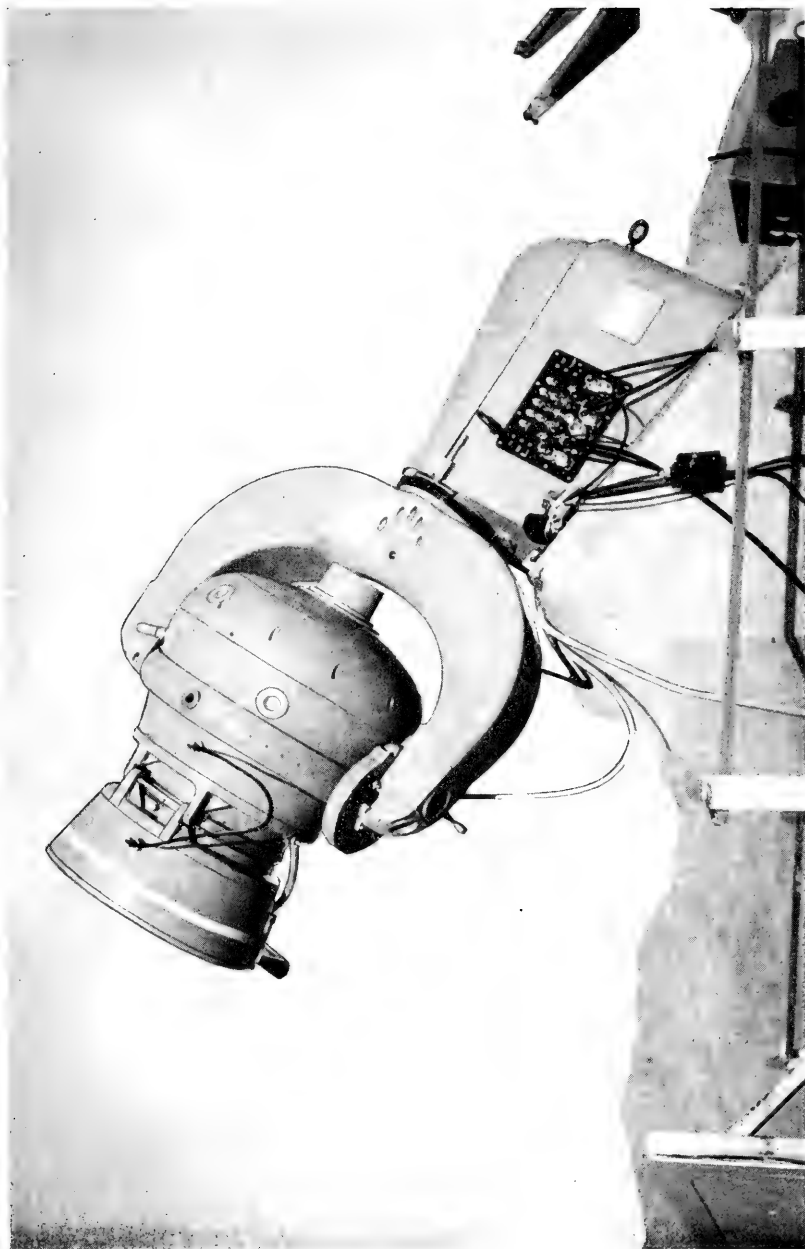

FIGURE 4.—Design of the optics of the Baker Super-Schmidt meteor camera.



A stony meteorite from the collection of the Smithsonian Institution, found in Bennet County, South Dakota, 1934.



The Baker Super-Schmidt meteor camera.

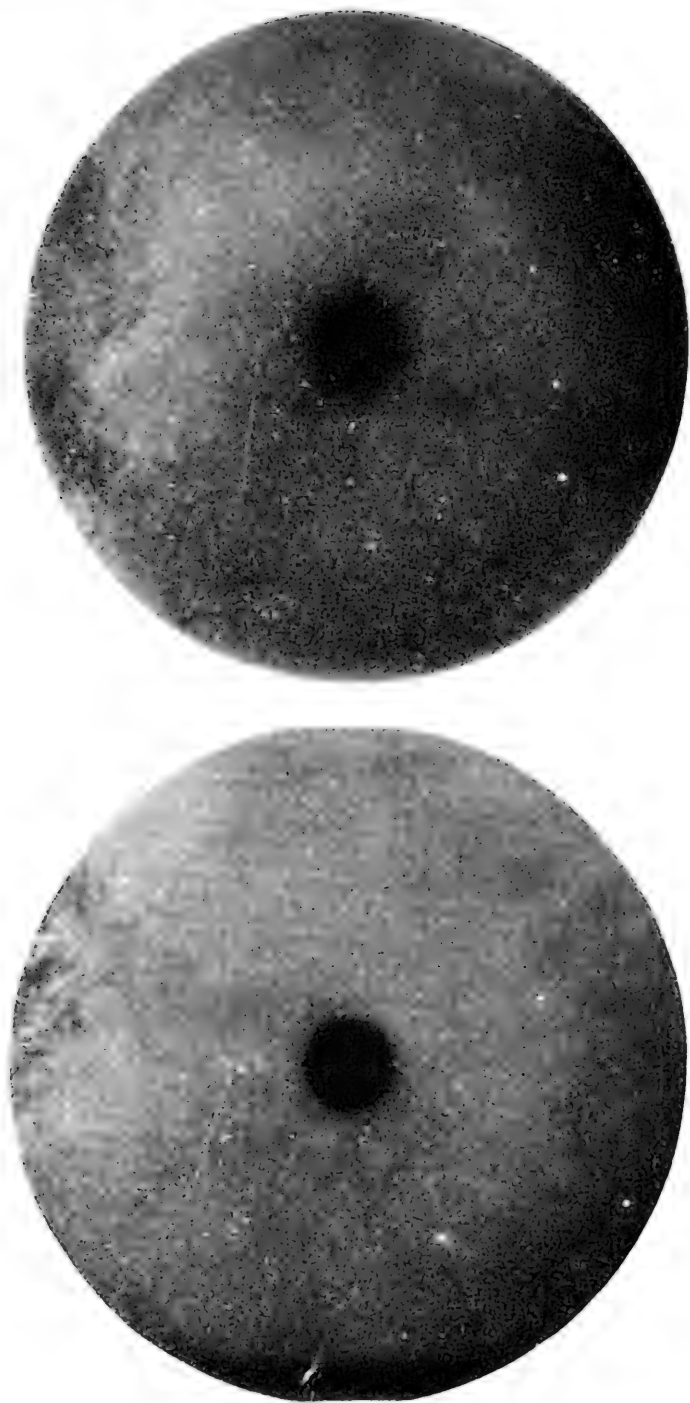

Two photographs of a Perseid shower made simultaneously from two stations in New Mexico



The Organ Mountains near Las Cruces, N. Mex., photographed with a 2-second exposure at midnight, in full moonlight, by a Super-Schmidt camera. The center circle was produced by the support from the rotating shutter, not by the moon.

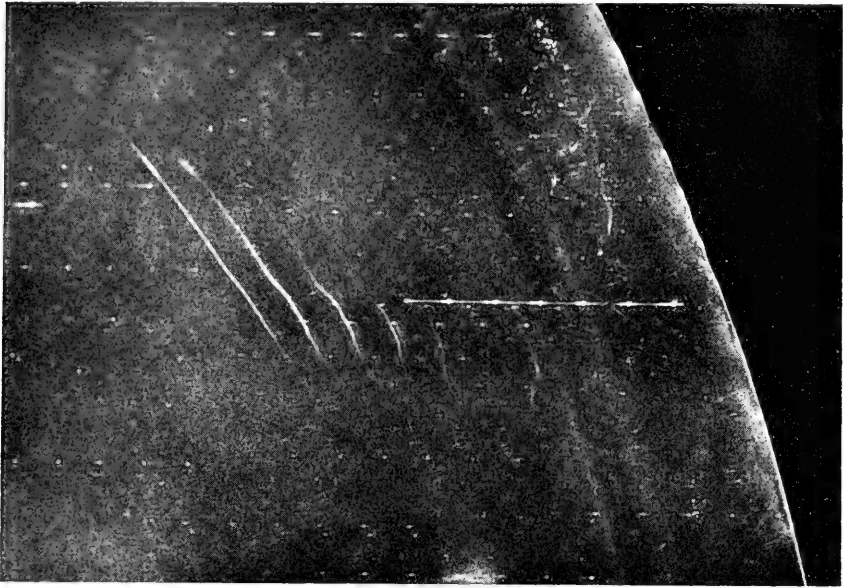

1. A persistent meteor train. Multiple photographs at the intervals of 2 seconds show the fading and distortion. (J. R. Coultis.)

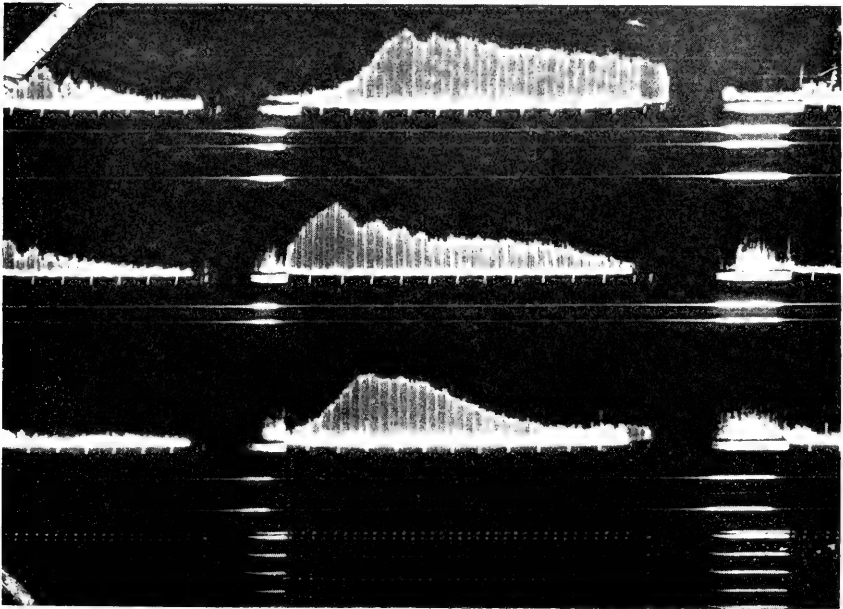

2. Record of radio pulses from a meteor. (J. G. Davies, Jodrell Bank, England.)

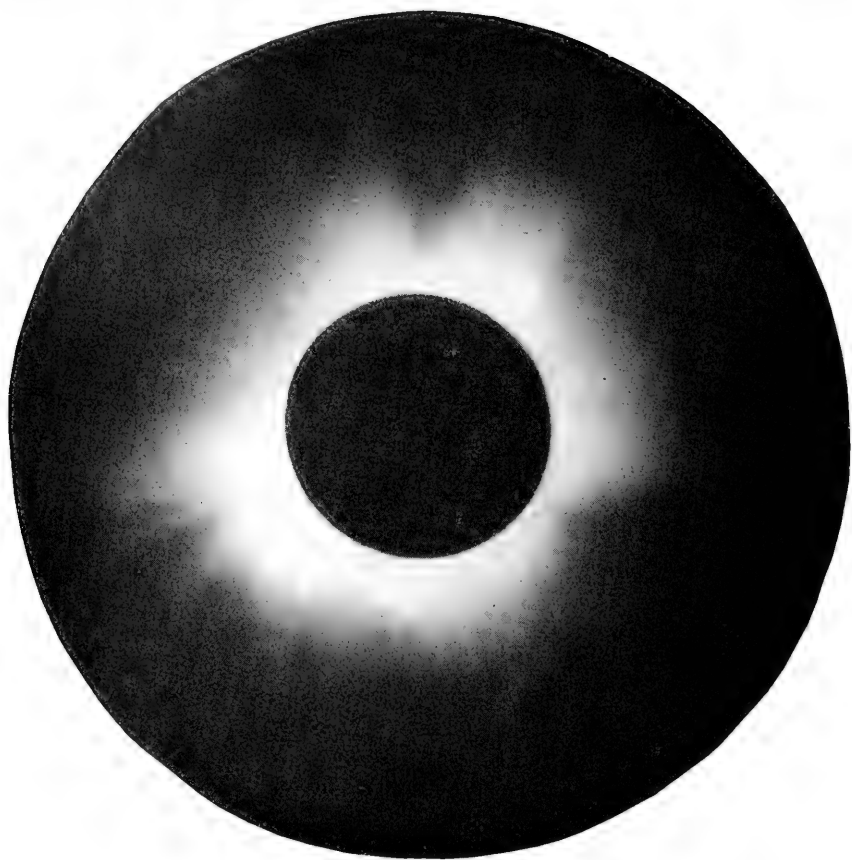

The solar corona photographed by Harvard during the 1937 solar eclipse.

in the atmosphere. We can determine the path of the meteor with an error of only a few feet, its velocity with an error of less than one part in a thousand, and measure its deceleration, caused by the resistance of the atmosphere, to a significant accuracy at several points along the longer trails. Dr. L. G. Jacchia, who has been in charge of the reduction and analysis of the data, finds that the faster meteors enter the atmosphere at an altitude of about 75 miles, and generally die out by an altitude of 50 miles. Some of the slowest meteors are first photographed well below 50 miles altitude and the largest of these has been followed down to an altitude of about 25 miles. The faster meteors are scarcely slowed down at all by the resistance of the atmosphere, but their surface rapidly disintegrates under the heat or friction of the atmosphere. When the meteor disappears practically nothing remains of its original mass, although the final particle is still moving at only a slightly reduced velocity. Some of the very slowest meteors move at speeds of only 7 to 8 miles per second; in one case only could we trace the meteor's speed down to about 5 miles per second.

In considering the large amount of light and heat generated by these small bodies as they pass through the earth's atmosphere, we must remember that their original kinetic energy corresponds to many times that of an equal mass of a high explosive such as TNT. Hence the energy of friction is adequate to remove and destroy the body before the remaining nucleus can be much slowed down by atmospheric resistance.

Among some 500 photographic meteors that have now been analyzed for velocities and orbits, we find no certain cases of meteors moving in hyperbolic orbits. That is, there are no meteors that certainly originated from interstellar space. If they exist, they must constitute not more than 1 percent of the total number of photographic meteors observed. Furthermore, the writer has shown that at least 90 percent of the photographic meteors pursue orbits similar to those of comets of both long and short period. If any average naked-eye meteors come from a broken planet the number does not exceed 10 percent of the total number observed and probably is less than 1 percent. Figure 5 shows the distribution of comet and meteor orbits arranged according to an arbitrary criterion, K , introduced by the writer (Whipple, 1954). The quantity K is defined as follows:

$$K = \log_{10} \left(\frac{q'}{1-e} \right) - 1 \quad (1)$$

where q' is the aphelion distance in astronomical units and e is the orbital eccentricity. The logarithmic quantity is the inverse square of the aphelion velocity.

Out of 1,600 known asteroids only 3 give positive values of the K criterion while some 13 of the shorter period comets give negative

values, as seen in figure 5. Approximately 10 percent of the sporadic and shower meteors have negative values of K , indicating the possibility, but not the certainty, that they may be of asteroidal origin. Orbital inclination is highly correlated with K in the sense that small values of K are associated with orbits of low inclination. Figures 6 and 7 show the orbits of some meteors, both sporadic and in streams, as determined photographically at Harvard.

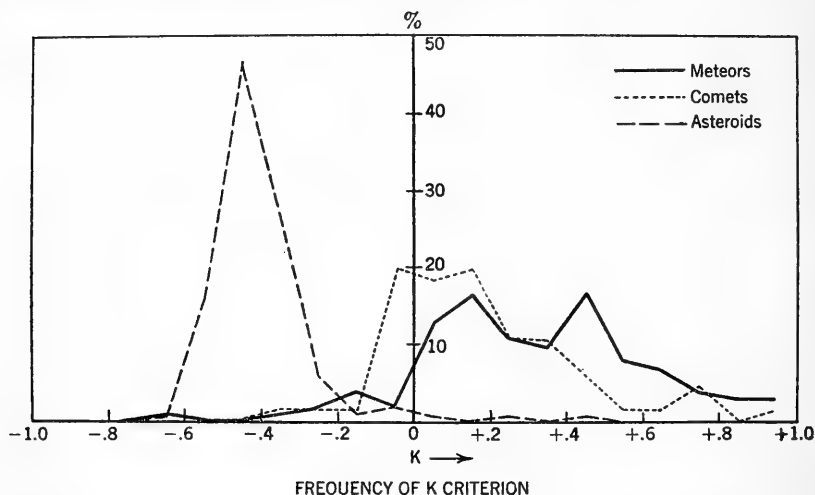

FIGURE 5.—The frequency of the criterion K among meteors, comets, and asteroids.

Although 21 meteor streams could be recognized from the first 144 photographic meteors, only 15 streams in all are yet certainly identified with individual comets. Only a few of these identifications have been made photographically. Twelve streams and their definite identifications with comets are indicated in table 1. The extensive discussion of comets, orbits, and meteor streams by Porter (1952) is highly recommended to those who are interested in the details of these relationships.

Perhaps the most interesting of these associations is that between the Taurid meteors of October and November and Encke's comet, the comet of shortest period, 3.3 years. The individual meteoric bodies in this stream are so widely distributed about the orbit of Comet Encke that the meteors can be seen to enter the earth's atmosphere from two moving radiants, one below the plane of the earth's orbit and one above it. Gravitational disturbances, or perturbations, by Jupiter have so distributed the orientation of the various orbits that an extraordinarily large volume of space is filled by particles that have been ejected from Comet Encke. Figure 8 shows the orbital shapes for both Encke's comet and the Taurid meteors. Whipple and Hamid (1951) have shown that some of these particles

were ejected from the comet approximately 5,000 years ago and another group more recently, about 1,300 years ago. It is not entirely clear whether these ejections represent unusually rapid disintegrations of the comet at those times, possibly by asteroidal collisions, or whether the perturbing action of Jupiter has been such as to make it possible for us now to observe only those meteors that were ejected at those two times. The latter hypothesis appears to be the more likely.

TABLE 1.—Comets and associated meteor streams

| Comet stream | q (A. U.) | P (yrs.) | Orbital elements | | | | |
|------------------------|----------------|---------------|------------------|----------|----------|--------|--------|
| | | | le | ω | Ω | i | π |
| 1861 I..... | 0. 921 | 415. | 0. 983 | 213° 4 | 29° 9 | 79° 8 | 243° 4 |
| Lyrids..... | 0. 918 | >50 | 0. 969 | 213. 9 | 31. 8 | 79. 9 | 245. 6 |
| 1910 II..... | 0. 587 | 76. 0 | 0. 967 | 111. 7 | 57. 3 | 162. 2 | 169. 0 |
| η Aquarids | | | | | | | |
| Orionids..... | 0. 542 | 21. 4 | 0. 930 | 86. 8 | 29. 8 | 163. 2 | 116. 5 |
| 1951 c..... | 1. 159 | 6. 1 | 0. 654 | 170. 4 | 94. 3 | 21. 7 | 264. 7 |
| June Draconids | | | | | | | |
| 1862 III..... | 0. 963 | 119. 6 | 0. 960 | 152. 8 | 137. 5 | 113. 6 | 290. 2 |
| Perseids..... | 0. 951 | 95. 1 | 0. 955 | 151. 2 | 138. 1 | 113. 7 | 289. 3 |
| 1946 V..... | 0. 996 | 6. 6 | 0. 72 | 171. 8 | 196. 2 | 30. 7 | 8. 1 |
| October Draconids | | | | | | | |
| 1950 e..... | 0. 338 | 3. 30 | 0. 847 | 185. 2 | 334. 7 | 12. 4 | 159. 9 |
| Taurids (N)..... | 0. 320 | 3. 13 | 0. 849 | 298. 4 | 221. 8 | 3. 2 | 160. 2 |
| Taurids (S)..... | 0. 372 | 3. 49 | 0. 835 | 111. 9 | 45. 1 | 5. 4 | 156. 9 |
| Arietids (S)..... | 0. 296 | 2. 64 | 0. 845 | 122. 2 | 27. 2 | 6. 0 | 149. 5 |
| β Taurids (Day) | | | | | | | |
| ζ Perseids (Day) | | | | | | | |
| 1866 I..... | 0. 977 | 33. 2 | 0. 905 | 171. 0 | 231. 4 | 162. 7 | 42. 4 |
| Leonids..... | 0. 985 | 37. 5 | 0. 918 | 173. 7 | 235. 0 | 162. 5 | 48. 7 |
| 1852 III..... | 0. 861 | 6. 6 | 0. 756 | 223. 3 | 245. 9 | 12. 6 | 109. 1 |
| Andromedids..... | | 6. 6 | | | | | |
| 1917 I..... | 0. 190 | 145. 3 | 0. 993 | 121. 3 | 87. 5 | 32. 7 | 208. 8 |
| Monocerotids..... | 0. 186 | | 1. 002 | 128. 2 | 81. 6 | 35. 2 | 209. 9 |
| 1939 X..... | 1. 022 | 13. 6 | 0. 821 | 207. 0 | 269. 8 | 54. 7 | 116. 8 |
| Ursids..... | 0. 915 | 14. 37 | 0. 845 | 212. 2 | 264. 6 | 52. 5 | 116. 8 |

Orbital elements for the comets: Baldet and de Obaldia (1952).

Orbital elements for the meteor streams: Whipple (1954).

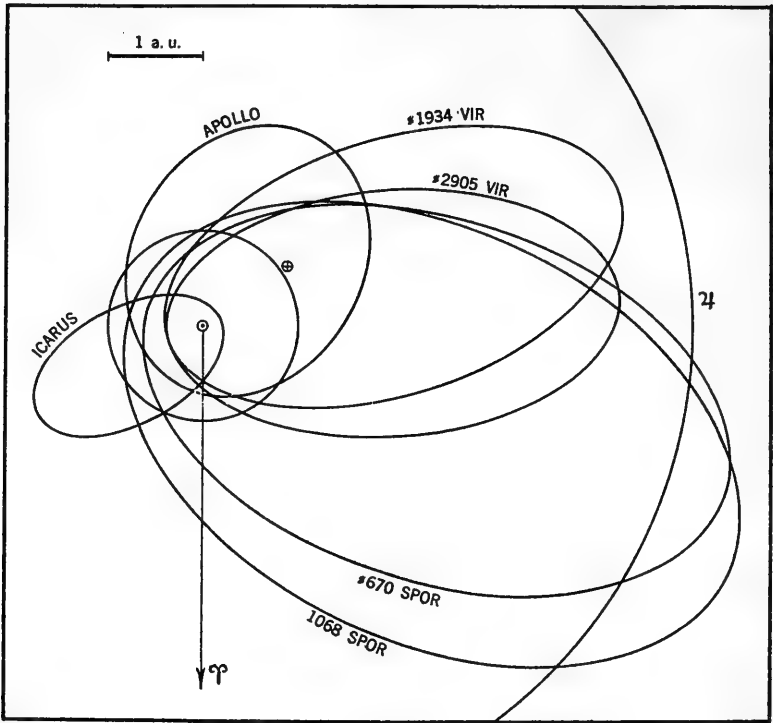

FIGURE 6.—The orbits of two sporadic meteors and two streams of the Virginid shower, with the orbits of the asteroids Icarus and Apollo for comparison.

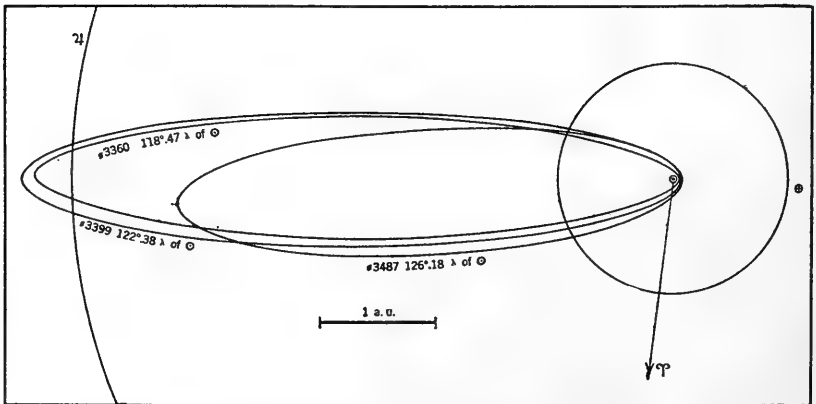

FIGURE 7.—The orbits of three δ -Aquadrid meteors ($q=0.07$ A. U.)

Probably a comet ejects meteoric material continuously, at least every revolution near the time of perihelion passage. It is an interesting commentary on these conclusions that the Taurid meteor stream had been first identified as a hyperbolic meteor stream by earlier investigators.

Our measures of the detailed meteoric photographic processes give us added information concerning the nature of the bodies that produce the ordinary visual or photographic meteors. Jacchia (1955) showed that the irregular bursts in the light curves of some meteors were accompanied by a shortening of the lifetimes. He concluded that bursts in these meteors represent a rapid disintegration or fragmentation of the meteoric body at irregular intervals along their trails.

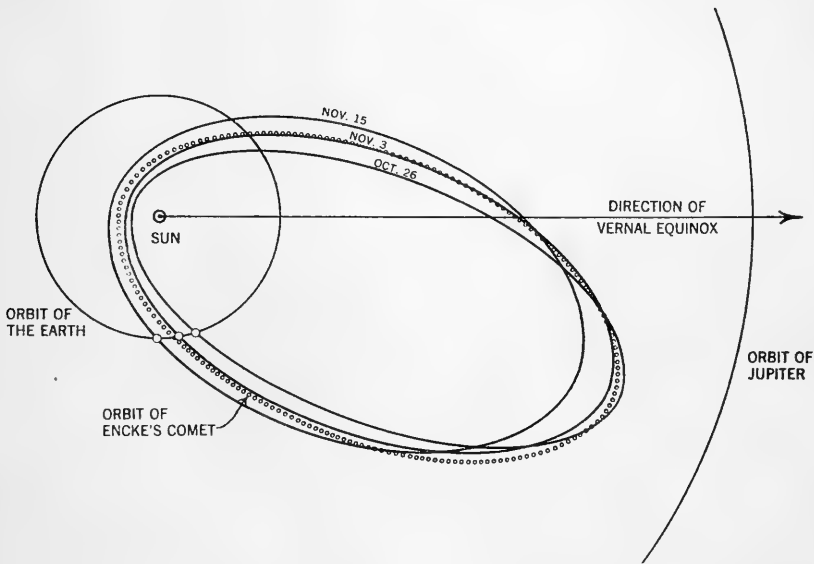

FIGURE 8.—The orbits of Encke's comet, and of three meteors of the associated northern Taurid shower that struck the earth's atmosphere on the dates shown.

Measurements of the slowing down of meteors, or atmospheric resistance, lead to the determination, for each meteor, of the quantity, surface-frontal-area divided by the mass. A knowledge of the atmospheric density, now provided by rocket techniques, enables us to determine the quantity $m^{1/2}\rho_m^{3/4}$ where m is the mass of the meteoric body and ρ_m its density. If we knew the amount of light that should be produced by a given meteoric mass at a given velocity we could immediately calculate, from the light curve and the velocity measurements, the initial mass of the body. Unfortunately, the theoretical determination of this so-called luminous efficiency is not yet

possible. Thus, in the meteoric problem, we find relationships that involve the mass, the density, and the luminous efficiency, but we cannot determine any one of these quantities separately. Knowledge of any one, on the other hand, would lead us immediately to accurate determinations of the other two quantities for observed meteors.

Since there is every reason to believe that the energy available for light production cannot exceed the original kinetic energy of the body, an upper limit to the density of the meteoroid and a lower limit to its mass can be approximated. The writer found (Whipple, 1955a) from such calculations that the densities of meteoric bodies must be of the order of unity, the density of water, or less.

Recently, Allan F. Cook and the writer have developed a technique (see Whipple, 1955c) for measuring the masses of meteors. We measure the motions in persistent meteor trains, the faint light left along the trails of fast bright meteors after the body has passed. Photographs of such trains, made by opening and moving the Super-Schmidt meteor cameras at 2-second intervals after bright meteors had passed, make it possible to measure winds in the high atmosphere (see pl. 5, fig. 1). In one case of a multiple-photographed double-station train, it was possible to measure the forward or coasting momentum of the meteoric gases and trapped air masses. This first result indicates that the density of a meteor is as low as 0.05 gm/cm³ or $\frac{1}{20}$ the density of water.

If a body is much less dense than water but is still made of ordinary earthy materials, one would expect it to be exceedingly porous and, therefore, exceedingly fragile. McCrosky (1955), who has been studying the fragmentation problem in photographic meteors, finds that among the faint meteors some 20 percent become luminous almost instantly instead of increasing their light gradually as the well-behaved meteor does. He concludes that these bodies must become visible because of sudden fragmentation of the entire meteoric mass. He finds indeed that this fragmentation occurs at a nearly constant pressure introduced by the resistance of the atmosphere, a pressure of only one-third of a pound per square inch. Many of the meteoric masses are so fragile that a block a foot or two in height would crush at the bottom under its own weight, at normal gravity.

Thus we have evidence that meteoric bodies from comets are extremely fragile, of low density, and, therefore, very porous. This conclusion is to be expected from the writer's hypothesis (Whipple, 1953) concerning the nature of the comets from which this debris has been ejected. According to this theory, the nucleus of a comet is a conglomerate of interstellar or interplanetary dust formed from gases at a temperature of only a few degrees absolute, perhaps when the sun and planets were formed. Cometary activity is then the result

of solar heating that vaporizes ices at the surface of the cometary nucleus. These ices include ordinary ice from water, solid ammonia, possibly even solid methane, and other compounds of carbon, nitrogen, and oxygen with hydrogen.

The remaining meteoritic material, made of the heavier, less volatile compounds in the original dust, must remain very loosely cemented. Most of this material is fragmented into extremely fine particles by the cometary ejection process, but a small amount of it holds together sufficiently well to form the cometary streams of meteors and the sporadic meteors from comets.

One would expect, on the basis of typical cosmic abundances, that the initial cometary nucleus might be about the density of water and that the final density of the meteoritic material might be the order of one-third the density of water. On the other hand, it is very likely that the initial dust in space consists of extremely porous masses, comparable to low-density smoke particles observed from artificial sources. Hence the cometary nucleus itself can be of very low mean density, and the final meteoritic fragments even more porous and rare. It is not certain whether we shall be able to recover such fragile fragments on the surface of the earth, because of their violent interaction with the earth's atmosphere. Tiny ones may come through without being seriously damaged.

While the photographic method of studying meteors was being perfected, a radically different and powerful technique came into use. Chamanlal and Venkataraman (1941), of India, heard whistles from continuous-wave radio transmitters, audible simultaneously with the occurrence of bright meteors. Pierce (1938) at Harvard and Hey (see Hey and Stewart, 1947) at Cambridge, England, working with a pulse transmitter and receiver on the same frequency, observed transient echoes from meteors. A number of investigators rapidly developed methods for detecting the ionization, or electron columns, produced as meteoric bodies plunge through the earth's atmosphere. The methods fundamentally depend upon the fact that the electromagnetically vibrating waves from radio transmitters set the individual electrons into synchronous vibration. The electrons, because of this induced vibration, act as independent transmitters and send out radio waves of the same frequency. Thus a column of electrons effectively reflects a radio wave as the electrons along the column resonate in phase with the initial radiation. The reflection is much like that of light from a shiny cylinder.

Without becoming involved in the complexity of electronic techniques we can understand, qualitatively, one of the most useful methods of tracking meteors by radio, and of determining meteoric velocities. In figure 9 we see that as the ionization trail of the meteor

progresses through the atmosphere, re-radiation (reflection) from the electrons in the trail occurs along its entire length to the head of the meteor. A relatively wide antenna beam can cover the entire trail. At an early part of the trail, say point *a* in figure 9, the distances from the radio transmitter to the successive positions along the trail and back to the receiver will vary rapidly as we move along the trail. Hence the returning waves will be successively in and out of phase because the radio wavelength, only a few meters, is very small compared to the distance, 100 or more kilometers. Little "reflected" radiation, therefore, will reach the receiver when we add up the contributions for an appreciable distance along the trail.

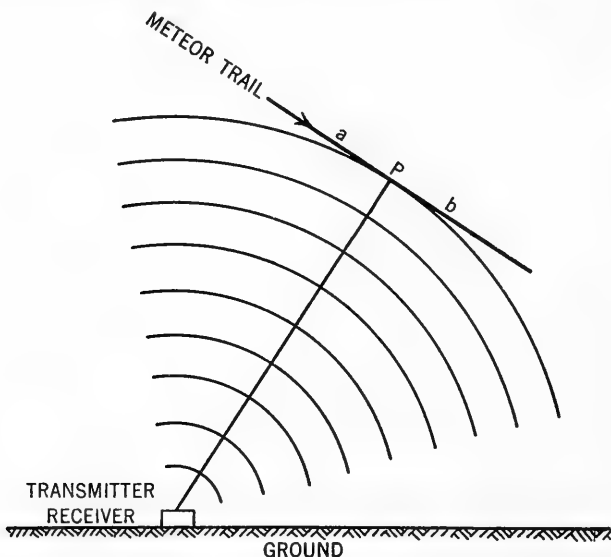

FIGURE 9.—Schematic diagram showing the geometry of radio echoes reflected from the ionization trail of a meteor.

As the meteor approaches the so-called reflection point of the trail, where the line from the radio to the trail meets it at perpendicular incidence, we see that a considerable length of the trail will be at almost the same distance from the radio transmitter. Echoes from this region will return to the receiver in phase and add up to produce a perceptible signal. The problem of the theoretical signal strength of the received echo, as the meteoric body moves along the trail, was in reality solved more than 100 years ago by Fresnel, who calculated the effect of such phase phenomena for light scattered by a line. The resulting signal strength as a function of distance along the trail is shown in plate 5, figure 2. The echo grows in intensity as the reflection point is reached, then increases beyond this value to a maximum in a very short time; then as it slowly fades out it oscillates

in strength with increasing distance from the reflection point. For a specified wavelength of the radio waves, such a curve yields the angular velocity of the meteor at a point where it passes perpendicular to the line of radio sight.

Ordinary radar techniques with pulses measure the time required for the radio signal to travel from the transmitter to the trail and back to the receiver again, and hence the distance to the reflection point. The angular velocity coupled with the distance then determines the true spatial velocity of the growing ion column, and therefore of the meteoric body in its trajectory. This method and similar related methods for measuring meteor velocities were developed chiefly by scientists in England. (See Davies and Ellyett, 1949; Manning, Villard, and Peterson, 1949; Hey, Parsons, and Stewart, 1947; McKinley, 1951; and Lovell, 1954.)

From more than 10,000 measurements of meteoric velocities, McKinley (1951) concludes that the velocities determined even from very faint radio meteors, somewhat below naked-eye visibility, do not indicate a statistically significant number of hyperbolic velocities, beyond the parabolic limit of 72 km./sec. Similarly, Almond, Davies, and Lovell (1953) at Manchester, England, come to the same conclusion from a more detailed analysis of fewer meteors, observed from radiants near the apex of the earth's motion in the early morning hours, and from the antapex direction in the early evening hours. At present, no clear evidence for the existence of any hyperbolic meteors has been found by radio-meteor astronomers. The general uncertainties in the methods of observation, however, permit the possibility that as many as one-half of 1 percent of the total might come from outer space.

The radio technique is capable of detecting meteors whose luminosity is 100 times fainter than that of meteors we can detect visually. The radio and photographic results are in full agreement and indicate that at least 99.5 percent of all the observed meteors are certainly members of the solar system.

A method of determining the radiant points of meteor streams by means of radio echoes was developed by Clegg (1948). Later Aspinnall, Clegg, and Hawkins (1951) carried out a continuous survey of stream radiants using twin antenna beams. Radio echoes were obtained in turn in each antenna, as the earth rotated, and the time of appearance of long-range echoes gave the time of transit and declination of the radiant.

An extremely important property of the radio technique was first demonstrated when Hey and Stewart (1947) discovered extremely dense meteor streams in the daylight hours, particularly in May, June, and July. Thus the radio technique has the enormous advan-

tage over the photographic that it can operate for 24 hours of the day regardless of sunlight, moonlight, or other sky illuminations. It is interesting that one of the daylight streams, according to the results of Clegg, Hughes, and Lovell (1947) turns out to be a recurrence of the Taurid meteor stream contributed by Encke's comet. In a sense, the writer predicted the existence of this stream (Whipple, 1939), although in 1939 he had no premonition that radio techniques might eventually be developed to observe it. It seemed quite likely, however, that bright fireballs from the other intersection of the Taurid stream with the earth's orbit might be seen emanating from the general direction of the sun.

Davies of Manchester has recently developed a most remarkable method for using radio techniques, to measure not only the velocity of a meteor, but also its trajectory and spatial orbit. Davies' method depends upon simultaneous observations from three stations, and provides meteor velocities and orbits for particles several times smaller than those visible to the eye. He finds that these smaller bodies move in orbits that are smaller and more nearly circular than those of the larger photographic meteors. The explanation of this observation will bring us around, full circle, to the problems of the micrometeorites.

Van de Hulst (1947) and Allen (1947) have demonstrated that micrometeorites are sufficiently numerous near the plane of the earth's orbit to scatter most of the sunlight seen in the zodiacal light, the twilight glow along the zodiac near sunrise or sunset. They find also that along the line of sight near to the sun these small particles diffract the sunlight and scatter it sufficiently to form an appreciable fraction of the solar corona (see pl. 6). The corona, of course, consists also of sunlight scattered by electrons as well as extremely strong bright lines from the million-degree gases in the sun's huge extended atmosphere. From his calculation of the scattering and diffracting power of the micrometeorites near the plane of the earth's orbit in space, van de Hulst estimates that some 10,000 tons of this fine dust should fall on the earth per day. He also concludes that most of the dust particles are smaller than 0.03 cm. (0.01 inch) in diameter. This estimate of the total fall on the earth is more than 1,000 times greater than Watson's (1941) earlier estimate based upon the infall of larger pieces of meteoritic material. Some direct substantiation of van de Hulst's conclusion, however, is given by the fact that noises of meteoric impact on high altitude rockets have been recorded by Bohn and Nadig (1950), of Temple University, and by Berg and Meredith (1956), of the Naval Research Laboratory.

Pettersson and Rotschi (1950, 1952) find also that deep-sea oozes contain appreciable quantities of nickel which may possibly derive from this interplanetary dust.

The writer (Whipple, 1955b, 1955c) has recently shown that a few tons of cometary dust injected into the solar system each second would be adequate to maintain the zodiacal light indefinitely. The particles are continuously lost by collisions among themselves, by the gravitational effects of the planets, particularly Jupiter, by the interstellar wind produced by the sun's motion through the interstellar gas, by the action of sunlight according to the Poynting-Robertson effect, and by corpuscular radiation from the sun in the form of outgoing hydrogen protons. Öpik (1956) has shown that the extended solar corona also adds drag to these little particles. The three latter effects cause the particles in the zodiacal cloud to spiral slowly in toward the sun, the rate depending upon the size of the particle. Piotrowsky (1953) has also shown that the grinding of the asteroids may produce sufficient material to maintain the zodiacal cloud. At the moment it is not possible to distinguish certainly between these two hypotheses but other evidence suggests that the cometary source is much the more important. Observational and theoretical advances should settle the question definitively within the next few years.

Now we can bring together, to complete this discussion, radio meteors, photographic meteors, the zodiacal light, micrometeorites, comets, and corpuscular radiation from the sun. If meteoric densities are typically as low as our single measure suggests, the discrepancy van de Hulst (1947) found between the total influx of zodiacal particles and meteoritic masses disappears. He measured the integrated dimensions of the interplanetary matter rather than its mass; hence a low density would reduce his estimate many times. Furthermore, the low density would increase the older estimate of the total meteoritic masses, and hence remove the discrepancy entirely.

The continual bombardment of meteoric debris of course constitutes a real hazard to rockets, artificial satellites, and space vehicles, which may be subjected to erosion or puncture. Elaborate ballistics experiments and careful calculations have shown, however, that optical surfaces exposed to space should not be affected functionally in less than about a year, and that for the presently planned small satellites, the rate of puncture will be, on the average, only about once in five days.

Probably about 2,000 tons of meteoritic debris fall on the earth from interplanetary space each day. This large mass, however, is still quite negligible compared to that of the earth. In five million years the total accumulation would add up to only an inch over the entire surface.

Although some of our discussion has led beyond the borderline of scientific certainty, I have attempted to distinguish clearly between

proven fact and hypothesis. By thus stepping over into unexplored areas, we can see more clearly the exciting possibilities of future research and, at the same time, appreciate some of the great progress already made in this rapidly growing field of astronomy.

ACKNOWLEDGMENTS

I am particularly grateful to Miss Frances W. Wright for the use of table 1 and for her assistance in preparing the figures. Dr. Gerald S. Hawkins has been very helpful in assisting in matters pertaining to radio-meteor astronomy, and Mrs. Lyle Boyd and Dr. Richard E. McCrosky have contributed to the final manuscript.

REFERENCES

- ALLEN, C. W.
1947. The spectrum of the corona at the eclipse of 1940 October 1. *Month. Not. Roy. Astron. Soc. London*, vol. 106, pp. 137-150.
- ALMOND, M.; DAVIES, J. G.; and LOVELL, A. C. B.
1953. The velocity distribution of sporadic meteors. IV. Extension to magnitude +8, and final conclusions. *Month. Not. Roy. Astron. Soc. London*, vol. 113, pp. 411-427.
- ASPINALL, A.; CLEGG, J. A.; and HAWKINS, G. S.
1951. A radio echo apparatus for the delineation of meteor radiants. *Phil. Mag.*, vol. 42, pp. 504-514.
- BALDET, F., and DE OBALDIA, G.
1952. *Catalogue général des orbites de comètes de l'an -466 à 1952*. Paris Obs., Sect. Astrophys. de Meudon.
- BALDWIN, R. B.
1949. *The face of the moon*. University of Chicago Press.
- BERG, O. E., and MEREDITH, L. H.
1956. Meteorite impacts to altitude of 103 kilometers. *Journ. Geophys. Res.*, vol. 61, pp. 751-754.
- BOHN, J. L., and NADIG, F. H.
1950. Researches in the physical properties of the upper atmosphere with special emphasis on acoustical studies with V-2 rockets. *Res. Inst. Temple Univ.*, Rep. No. 8, pp. 1-26.
- BUDDHUE, J. D.
1950. Meteoritic dust. *Univ. New Mexico Publ. Meteoritics*, No. 2.
- CHAMANLAL, and VENKATARAMAN, K.
1941. Whistling meteors—a Doppler effect produced by meteors entering the ionosphere. *Electrotechnics (Bangalore)*, No. 14, p. 28.
- CLEGG, J. A.
1948. Determination of meteor radiants by observation of radio echoes from meteor trails. *Phil. Mag.*, vol. 39, pp. 577-594.
- CLEGG, J. A.; HUGHES, V. A.; and LOVELL, A. C. B.
1947. The daylight meteor streams of 1947 May-August. *Month. Not. Roy. Astron. Soc. London*, vol. 107, pp. 369-378.
- DALY, R. A.
1947. The Vredefort ring-structure of South Africa. *Journ. Geol.*, vol. 55, pp. 125-145.

- DAVIES, J. G., and ELLYETT, C. D.
1949. The diffraction of radio waves from meteor trails and the measurement of meteor velocities. *Phil. Mag.*, vol. 40, pp. 614-626.
- HENDERSON, E. P.
1949. American meteorites and the national collections. *Ann. Rep. Smithsonian Inst. for 1948*, pp. 257-268, 6 pls.
- HEY, J. S.; PARSONS, S. J.; and STEWART, G. S.
1947. Radar observations of the Giacobinid meteor shower, 1946. *Month. Not. Roy. Astron. Soc. London*, vol. 107, pp. 176-183.
- HEY, J. S., and STEWART, G. S.
1947. Radar observations of meteors. *Proc. Phys. Soc. London*, vol. 59, pp. 858-883.
- JACCHIA, L. G.
1955. The physical theory of meteors. VIII. Fragmentation as a cause of the faint-meteor anomaly. *Astrophys. Journ.*, vol. 121, pp. 521-527.
- LOVELL, A. C. B.
1954. *Meteor astronomy*. Oxford.
- MANNING, L. A.; VILLARD, O. G.; and PETERSON, A. M.
1949. Radio Doppler investigation of meteoric heights and velocities. *Journ. Appl. Phys.*, vol. 20, pp. 475-479.
- MCCROSKY, R. E.
1955. Some physical and statistical studies of meteor fragmentation. Thesis, Harvard University.
- MCKINLEY, D. W. R.
1951. Meteor velocities determined by radio observations. *Astrophys. Journ.*, vol. 113, pp. 225-267.
- NININGER, H. H.
1952. *Out of the sky*. University of Denver Press.
- OLIVIER, C. P.
1937. Results of the Yale photographic meteor work, 1893-1909. *Astron. Journ.*, vol. 46, pp. 41-57.
- ÖPIK, E. J.
1956. Interplanetary dust and terrestrial accretion of meteoric matter. *Irish Astron. Journ.*, vol. 4, pp. 84-135.
- PETTERSSON, H., and ROTSCHI, H.
1950. Nickel content of deep-sea deposits. *Nature*, vol. 166, p. 308.
1952. The nickel content of deep-sea deposits. *Geochimica et Cosmochimica Acta*, vol. 2, pp. 81-90.
- PIERCE, J. A.
1938. Abnormal ionization in the E region of the ionosphere. *Proc. Inst. Radio Eng.*, vol. 26, p. 892.
- PIOTROWSKY, S. L.
1953. The collisions of asteroids. *Acta Astronomica*, vol. 5, pp. 115-136.
- PORTER, J. G.
1952. *Comets and meteor streams*. New York.
- SCHIAPARELLI, G. V.
1871. *Entwurf einer Astronomischen Theorie der Sternschnuppen*. Stettin.
- VAN DE HULST, H. C.
1947. Zodiacal light in the solar corona. *Astrophys. Journ.*, vol. 105, pp. 471-488.
- WATSON, F. G.
1941. *Between the planets*. Philadelphia.

WHIPPLE, F. L.

1938. Photographic meteor studies I. *Proc. Amer. Philos. Soc.*, vol. 79, pp. 499-548.
1939. Upper atmosphere densities and temperatures from meteor observations. *Pop. Astron.*, vol. 47, pp. 419-425.
1940. Photographic meteor studies III. The Taurid meteor shower. *Proc. Amer. Philos. Soc.*, vol. 83, pp. 711-745.
1950. The theory of micro-meteorites. I. In an isothermal atmosphere. *Proc. Nat. Acad. Sci.*, vol. 36, pp. 687-695.
1951. The theory of micro-meteorites. II. In heterothermal atmospheres. *Proc. Nat. Acad. Sci.*, vol. 37, pp. 19-30.
1953. On the icy conglomerate model for comets. *Mem. Roy. Soc. Sci. Liège*, vol. 23, No. 13.
1954. Photographic meteor orbits and their distribution in space. *Astron. Journ.*, vol. 59, pp. 201-217.
- 1955a. The physical theory of meteors. VII. On meteor luminosity and ionization. *Astrophys. Journ.*, vol. 121, pp. 241-249.
- 1955b. A comet model. III. The zodiacal light. *Astrophys. Journ.*, vol. 121, pp. 750-770.
- 1955c. *Trans. Int. Astron. Union*, vol. 9, p. 321.

WHIPPLE, F. L., and HAMID, S. E.

1951. On the origin of the Taurid meteor stream. *Helwan Obs. Bull.*, No. 41, pp. 1-30.

The Development of the Planetarium in the United States

By JOSEPH MILES CHAMBERLAIN

*Chairman, American Museum-Hayden Planetarium
New York City*

[With 6 plates]

THE RECORDS of nearly every civilization contain evidence of a fascination for the beauty of the skies. This fascination has often led to an attempt to explain what was seen, to somehow render understandable the complex and often confounding motions of the stars, planets, comets, and meteors to be observed on a clear night. The attempts to recreate these motions in a fashion that appeared simple and immediately comprehensible led to the construction of the planetarium.

One of the most ancient concepts of the universe that has been recorded comes from the Egyptians. They pictured the world as a rectangular box, with Egypt nestled among a ring of mountains in its bottom. On a river that flowed in the mountains above and around them was a boat which carried the sun. By night it went behind the mountains in the west but came again into view in the morning. The stars hung through ports from the great canopy above—the sky. Each represented a deity. Special gods were assigned to the planets to control them in their complex paths among the stars. This view of a mechanical universe was in essence a planetarium, for even though fanciful and erroneous, it portrayed in an understandable manner the motions of the celestial actors.

The Chaldeans developed a comparable model of the universe. In it, the earth is something like an overturned boat in appearance, rising gradually from the extremities to the center, like a great mountain. At the summit of the mountain, the Euphrates River had its source. Near the foot of the mountain, the edges of the boat curved outward to form an impregnable wall. The oceans formed in the resulting hollow and served as a sort of moat to separate man from the gods. The heavens rose above the “mountain

of the world" in a great dome. The sun gained daily access to the interior of the dome by way of doors in the east and west.

There have been many other attempts to depict and explain the motions of the celestial objects. Some have been preserved for their pure artistry, and most are evidence of a rather good comprehension of the mechanisms of the planets, sun, and moon. The Farnese Globe in the National Museum at Naples is a sculpture in white marble of Atlas supporting the world on his shoulders. Some of the constellation figures are carved in relief on its surface, as is the path of the sun. Dating back to 73 B. C., it is still another early attempt to illustrate and portray the skies. Other globes, with the Equator and the Tropics of Cancer and Capricorn painted on them, can be found to represent nearly every century of the Christian Era.

Mechanisms showing the relative motions of the sun, moon, and planets have been constructed at various times since the day of Christian Huygens (1629-1695) and Roemer (1644-1710). Huygens solved many of the mathematical problems involving the relative motions of the planets, which are essentially the same problems that must be solved for the gear trains of the most modern instruments. In England, a device of this type was built for Charles Boyle, the fourth Earl of Orrery (1676-1731), and was named for him. The name "orrery" is still used to apply to such pieces of apparatus. These machines usually consisted of a series of globes to represent the various objects in the solar system. Each globe was supported by a metal rod, and interrelated by the gearing at the central pedestal. Some undertook to reproduce the planetary satellites, properly relating their motions to those of the planets. Their complexity can be readily appreciated.

One of the most elegant of these orreries was on exhibit for several years at the Fels Planetarium of the Franklin Institute in Philadelphia. Known as the Rittenhouse Orrery, it was built for use at the College of Philadelphia in the early part of the nineteenth century. It was a remarkable device because of its accuracy in representing the Keplerian motion of the planets. Both the Fels Planetarium and the Buhl Planetarium and Institute of Popular Science in Pittsburgh exhibit the modern counterpart of these orreries. It is the planetarium built by M. Sendtner of Munich, and in addition to the planet representation it has the advantage that the observer may look through one glass surface of an enclosing sphere and look on the opposite surface to see the stars in their natural formations.

Still another variation to the orrery or planetarium was constructed in 1913 for the Deutsches Museum in Munich. It is a model of the solar system according to Copernicus. The distinguishing features are its size and its earth orientation.

Attached to the center of the ceiling of a room almost 40 feet in diameter is the sun globe. It is about 10 inches in diameter and contains a 300-watt light bulb which is the source of light for the entire room. The planets Mercury, Venus, the earth, Mars, Jupiter, and Saturn are represented by balls with diameters of from about 1.6 inches to about 8 inches. They move in orbits around the sun with speeds proportionate to their natural velocities. The earth completes a year in about 12 minutes.

The earth orientation derives from the carriage to which the earth ball is attached, and which moves around with it. An observer riding in the carriage, seeing the planets through a periscope as lighted by the "sun" against the constellations painted on the walls of the room, can readily appreciate the similarity to nature's planet family. In effect, he has seen an artificial sky that aims to reproduce the skies as seen from the earth. Of course, all comparative sizes and distances are distorted, and only one observer at a time can be carried on the earth carriage.

Another type of planetarium gives a somewhat superior reproduction of the skies to a few more viewers. One of the oldest examples is known as the Gottorp Globe. Finished in the 1660's, it was a sphere 11 feet in diameter, weighing $3\frac{1}{2}$ tons, and so constructed that about 12 persons could enter it, stand on a platform within it, and see the sky as viewed from the earth rather than from space beyond the earth. The Gottorp Globe had a typical map of the sky on its inner surface, and many stars were represented. Originally it was driven by waterpower to rotate once every 24 hours.

Roger Long, professor of astronomy at Cambridge, constructed an "Astronomical Machine" in the eighteenth century which was quite similar in basic design to the Gottorp Globe. Its interior platform accommodated about 30 people, and the stars were represented by holes punched into the 18-foot sphere. A light representing the sun could be moved along the proper path to simulate the sun's motion.

The twentieth-century version of these globes was constructed in 1911 for the Chicago Academy of Sciences after a design by Dr. Wallace W. Atwood, president of Clark University. It was 15 feet in diameter and electrically driven. Motions of both the sun and moon could be demonstrated.

Before the outbreak of World War I, Dr. Oskar von Miller, creator and director of the Deutsches Museum, approached the Zeiss firm regarding the construction of a planetarium that would show the movements of the heavenly bodies according to the Ptolemaic system on the interior of a hemispherical dome in the same manner as they appear to an observer on the earth. The first idea considered was to represent the stars by small electric bulbs attached to the dome, which

would have to be rotated around an axis parallel to the earth's axis. The sun, moon, and planets were to be represented by illuminated disks driven by a suitable gearing in such a way that the epicycle orbits of the objects would be truly represented. It soon became evident that it was impossible to solve the problem in this manner, and the outbreak of the war put a stop to the work.

Dr. W. Bauersfeld of the Zeiss works in Jena is credited with the suggestion that the new instrument be a projector:

The great sphere (the planetarium dome) shall be fixed; its inner white surface shall serve as the projection surface for many small projectors which shall be placed at the center of the sphere. The reciprocal positions and motions of the little projectors shall be interconnected by suitable driving gears in such manner that the little images of the heavenly bodies, thrown upon the fixed hemispheres, shall represent the stars visible to the naked eye, in position and motion, just as we are accustomed to see them in the natural clear sky.

After hostilities, work was begun once again on a planetarium that would incorporate all the advantages of the large globes and the orreries—a device that would reproduce the skies of nature just as accurately as possible.

In August of 1924, after nearly 5 years of design and construction in the famous Zeiss plant in Jena, the first modern planetarium instrument was produced. The illusion of reality surpassed the expectations of von Miller and even the Zeiss people themselves.

The prototype instrument was limited in latitude motion and had only one spherical star projector, but these faults were corrected. Soon, the dumbbell-shaped device, which has since become synonymous with popular astronomy lecturing, was in production. Twenty-five of these later models were built; most of them were installed in Europe, and six have been erected in the United States:

| <i>Planetarium</i> | <i>Location</i> | <i>Date of opening</i> |
|--|------------------------|------------------------|
| Adler Planetarium..... | Chicago..... | May 10, 1930 |
| Fels Planetarium..... | Philadelphia..... | Nov. 1, 1933 |
| Griffith Observatory and Planetarium.. | Los Angeles..... | May 14, 1935 |
| American Museum—Hayden Planetarium. | New York..... | Oct. 2, 1935 |
| Buhl Planetarium and Institute of Popular Science. | Pittsburgh..... | Oct. 24, 1939 |
| Morehead Planetarium..... | Chapel Hill, N. C..... | May 10, 1949 |

The projection apparatus that resulted is a weird-looking instrument about 12 feet long, with a large globe at each end. These two

globes contain the projectors of the fixed stars, one globe for the northern hemisphere of the sky, one for the southern. The lantern slides, or diapositives, are so shaped that their images fit together to make a complete picture of the starry heavens.

The main structure, containing all the projectors, is so mounted that it may turn independently about any one of three axes. First, it may turn about an axis parallel to the polar axis of the earth. When this motion is used without other motions, the effect naturally is to transport the images across the dome sky in exactly the same way that the daily rotation of the earth on its axis apparently moves the real bodies across our sky each 24 hours.

Second, the machine may rotate about an axis perpendicular to the plane in which the earth moves about the sun. Without the other motions in use, the effect of this is to swing the north pole of the sky around the circle that it makes each 26,000 years with the precessional "wobbling" of the earth's axis. Thus one can go backward or forward in time. For example, the lecturer can set the instrument back some 5,000 years to 3,000 B. C. when Alpha Draconis was our North Star. Or, by putting the instrument ahead some 12,000 years, we see Vega marking the north pole of the heavens, and the Southern Cross visible from the latitude of New York. The axis of this precessional motion of the instrument intersects the daily-motion axis at the center of the room.

Third, through this same intersection runs the axis for the remaining motion of the machine, a horizontal one from the east to the west point. Rotation about it transports the images on the dome as if the viewer of the skies were traveling along a meridian of the earth from pole to pole. This is used to demonstrate the changed appearance of the skies from different latitudes of the earth, so that one may go to the Land of the Midnight Sun, or to the North Pole, and observe the apparent movement of sun, moon, and stars from there. Or, traveling south, one may see the Magellanic Clouds, Canopus, and the Southern Cross.

The heavy moving parts of the machine are carried on a light but carefully built steel latticework.

The whole apparatus has several different speeds, all of which are many times faster than the real motions. This makes it possible to condense a very long astronomical story, so that anyone can get a clear understanding in a few minutes of the seemingly intricate, though actually simple, workings of the heavenly bodies.

Nearby objects such as the planets and the sun and moon, which appear to move against the background of the stars from day to day, are represented by separate projectors having independent

motion on the main part of the machine. In nearly all cases the lamps are tungsten-filament electric, and are part of a projection system that includes a condensing or light-gathering unit, a diapositive or its equivalent, and an objective or projection lens system which focuses on the dome an image of the illuminated diapositive. The diapositives for the star-field projectors are not photoemulsions on glass, but pieces of copper foil with small round holes punched in them for the stars. These punchings are varied in size in accordance with the brightness of the real stars they represent. Holes for the faintest stars are of the order of one-thousandth of an inch in diameter. The 16 star-field projectors mounted in each ball at the ends of the dumbbell are lighted by the one light in the center.

A further point of interest regarding the projectors is the provision made in all of them to cut off their light when they are pointed below the horizon, thus keeping their direct light from the eyes of the audience. In nearly all instances the occulting device is a cup-shaped, gravity-operated shield that slowly swings into the projection beam as the projector is tilted downward.

The prime movers for the machine are small 3-phase alternating-current motors; reversal of phase accomplishes reversal of direction of rotation. They are all mounted on the main moving part. Transmission and interconnection are accomplished by gearing. Motions that are additive are joined through planetary transmissions. The motions and lamp circuits are all controlled remotely by the lecturer from a switchboard in a speaker's stand near the wall of the room. Here on the horizontal part of the main board are labeled switches for every motor or lamp, and rheostats or powerstats for controlling the brightness of the lamps in use.

It might be helpful at this point to differentiate between the planetarium as a device or training aid, as just described, and the planetarium as an institution, its more appropriate usage in the context of current-day function. All the planetariums in the United States are organizations that serve several purposes, though the popular program of explication in astronomy is usually the primary mission. No matter whether the projection instrument is used or not, one refers to the "planetarium" when speaking of the organization.

ADLER PLANETARIUM

Aside from the orreries, globes, and armillary spheres that made their appearances in many schools and museums, the first planetarium venture in the United States was brought to reality in Chicago. Max Adler, a former official of Sears, Roebuck & Co., generously donated \$500,000 to the city of Chicago to purchase a Zeiss planetarium instru-

ment for that city. The dedication plaque has an inscription that might have defined the purpose of the new enterprise:

THE ASTRONOMICAL MUSEUM AND PLANETARIUM OF CHICAGO
GIFT OF MAX ADLER

To further the progress of science
To guide an understanding of the majesty of the heavens
To emphasize that under the great celestial firmament there is order, independence and unity
1930

Mr. Adler, in his dedication address, further amplified:

Chicago has been striving to create, and in large measure has succeeded in creating, facilities for its citizens of today to live a life richer and more full of meaning than was available for the citizens of yesterday . . .

The popular conception of the universe is too meager; the planets and the stars are too far removed from general knowledge. In our reflections, we dwell too little upon the concept that the world and all human endeavor within it are governed by established order and too infrequently upon the truth that under the heavens everything is interrelated, even as each of us to the other . . .

The planetarium has been the subject of praise by scientists and educators. One of them has characterized it as "a schoolroom under the vault of heaven" and as "a drama with the celestial bodies as actors." . . .

It is my hope that the youth of our city, and indeed of other cities, may through this dramatization find new interests and fresh inspiration and also that with the aid of the Planetarium and Astronomical Museum, science may be advanced (Fox, 1932).

Thus the stage was set. The planetarium in the United States was more than just an exhibit; it was to be an institution with several masters to serve: education, science, pleasure, and the realm of the spirit.

The building was designed to implement the purposes as outlined by Mr. Adler. The largest single space is allotted to the planetarium chamber on the second floor, and surrounding it are exhibit areas, offices, a library, and an entrance foyer. The lower level contains a lecture hall, shops and work space, machinery rooms, rest rooms, and additional exhibit areas.

The attendance during the first year was 731,108—certainly evidence of the attractiveness of the new institution. During the Chicago World's Fair, when the building was within the fair grounds, attendance reached an all-time high of 925,156. Administratively, the organization has been under the cognizance of the Chicago Park District. In practice, it has been an entity within itself, quite independent from the District, especially where educational and scientific policy are concerned. It has had the further advantage of advice and assistance from the Adler Planetarium Trust, a group of interested laymen headed by Robert S. Adler, son of the donor.

FELS PLANETARIUM

Shortly after the Adler Planetarium and Astronomical Museum was opened, the announcement was made that Philadelphia would have the privilege of being the second city in the United States to possess a Zeiss planetarium. Samuel S. Fels, the great philanthropist of that city, impressed with the educational value of the planetarium, donated a large sum for the purpose. The new installation was embodied in the new Franklin Memorial and the Franklin Institute Museum. The city of Philadelphia set aside a whole city block just a few minutes from the City Hall and adjacent to Logan Circle. The planetarium has its home in that section of the Museum building which is devoted to astronomy. It has a separate outside entrance and can be operated separately from the Museum if desired.

A strong feature is the observatory. In addition to the projection theater, there is a rooftop dome housing a 250-mm. Zeiss refracting telescope especially fitted out for lecturing and demonstration. Many evening performances in the dome are supplemented by a visit to the observatory for first-hand contact with the real sky.

The Fels Planetarium has established itself through the years as a leader in the offering of special astronomy lectures for school groups. The Philadelphia Board of Education has had the foresight to recognize the unequaled educational value of the planetarium, especially if the lectures offered in it are integrated with the curriculum in the schools. To facilitate the scheduling of such school groups at a time most valuable to them with respect to their progress in science, the Board has placed employees at the Franklin Institute. Most other planetariums have offered similar programs for the youth of the area they serve, but none is better planned or organized than in Philadelphia.

GRIFFITH OBSERVATORY AND PLANETARIUM

Still another planetarium was opened to the public on May 14, 1935, in Los Angeles, Calif. It was a present to the City of Los Angeles provided for in the will of Col. Griffith J. Griffith. Like its predecessors in Chicago and Philadelphia, it featured the Zeiss projection planetarium, and like Chicago it was city owned and operated. Like Philadelphia, it possessed an observatory. The observatory was allotted architecturally as much prominence as the projection theater, and the organization became known as the Griffith Observatory.

The principal instrument in the observatory proper is a Zeiss 12-inch refractor. There is also a coelostat telescope which produces a large image of the sun on a screen in the Hall of Science. In the Hall of Science, in addition to the solar image, there are more than

100 exhibits demonstrating some of the most notable achievements in modern science. There is a Foucault Pendulum to demonstrate the rotation of the earth, an excellent model of the moon, and astronomical paintings and murals in abundance.

Situated on a hill overlooking the Los Angeles area, the Griffith Observatory and Planetarium has an enviable location.

AMERICAN MUSEUM-HAYDEN PLANETARIUM

The American Museum-Hayden Planetarium in New York is the Department of Astronomy of the American Museum of Natural History. It lays claim to the consistently highest attendance of any planetarium in the United States, and to the most extensive educational program. When it was opened to the public in October 1935, the program that was offered was a change in direction and intensity, but was actually an extension of the astronomical functions of the American Museum, which dated back to the nineteenth century. Dr. Clyde Fisher, long-time curator of astronomy, had visions in the early 1920's of an "ideal astronomic hall" that he had hoped would be built in the Museum. The plans, never brought to fruition, show a building, octagonally shaped, with a diameter of 126 feet and a height of 5 stories, surmounted by a dome. The Zeiss projector was to have been mounted at the center of the dome as a continuously operating exhibition—not a show or a lecture. There is a complete description of the plan in *Natural History Magazine* for July-August 1926. One can only regret that the ambitious, \$3,000,000 (in 1926!) dream never came into being.

In the spring of 1933, the trustees of the American Museum of Natural History formed a separate corporation, known as The American Museum of Natural History Planetarium Authority, thereby becoming eligible to apply to the Reconstruction Finance Corporation for a loan on a self-liquidating basis to construct and equip a planetarium. Charles Hayden donated the Zeiss projection instrument and the Copernican orrery devised for installation on the first floor.

Satisfied that the Museum's proposition was financially sound and that anticipated revenue from admission fees would be sufficient to offset operating expenses and also amortize the investment, the RFC granted a \$650,000 loan to construct the Planetarium building. In appreciation for Mr. Hayden's generous gift, the building was officially designated by the trustees as the Hayden Planetarium. The name was changed to American Museum-Hayden Planetarium in 1952 to more clearly establish the relationship to the parent organization.

After World War II, the trustees of the Museum purchased the outstanding bonds, in part with a donation from the Hayden Foundation. The Planetarium Authority is still responsible for retiring the remaining substantial debt.

The breadth of the program in New York is of special interest. The popular demonstration attracted over 600,000 in the fiscal year ended June 30, 1957. These people witnessed one of seven annual presentations, such as: "Earth, Air and Space," "Captives of the Sun," "The Christmas Star," "From Dusk to Dawn," "Time and the Stars," "Easter in the Heavens," and "A Trip to Palomar." A similar pattern of change in the popular offering is also characteristic of other American planetariums.

The American Museum-Hayden Planetarium offers courses in astronomy, navigation, and meteorology. These range from a Saturday morning course for young people to graduate courses for credit in cooperation with local colleges and universities. The series of courses in navigation (piloting, introduction to celestial navigation, advanced celestial navigation) has been especially well received.

Special demonstrations are given to about 20 local colleges as a supplement to their instruction in descriptive astronomy. This may consist of a single lecture annually or a series each semester. In every instance, efforts are directed toward satisfying the needs of the students involved after consultation between a Planetarium staff member and the college instructor.

Lectures are given weekly to students from the junior high schools of the City of New York. Other lectures are prepared for special groups.

To handle this extensive program, there is a staff of two astronomers (one of whom is chairman), two associate astronomers, two assistant astronomers, five special lecturers, and six instructors (these last two categories are part-time), and a supporting group of about 35 full-time employees.

BUHL PLANETARIUM AND INSTITUTE OF POPULAR SCIENCE

In 1939, the Buhl Planetarium and Institute of Popular Science was opened. Dr. Charles F. Lewis, director of the Buhl Foundation, in his address of presentation stated the reasons for establishing the new institution in Pittsburgh with great clarity and directness:

Why, it may be asked, should there be a planetarium? I will give you two reasons, either one of which I believe justifies the expenditure of funds and effort.

First, I believe that the oldest curiosity of man was about the stars; and I believe that this curiosity is infinitely worth satisfying. The heavens them-

selves were the world's first motion picture theater. The ancients had no broad, smooth highways upon which to speed in automobiles. They had no cinema. They had no brightly lighted concert halls. The heavens, at night, were their theater. We know that they watched the skies intently and we know that they peopled them with amazing creatures: the Great Bear and the Little Bear; the Dragon; the Charioteer; Orion, the great hunter, and his two dogs; Cygnus, the swan; and many others. And about them they wove legends and tales which have come down to us today. Sophisticated moderns that we are, we look at the stars and cannot for the life of us see the Great Bear. We call it the Big Dipper. We utterly fail to visualize the figures in the sky as the ancients did. This, we must believe, is because their imaginations were keener than ours, more naive and childlike, less dulled by artificial stimuli. Yet I have never known a city-bred person who, transported to the open country on a vacation, failed to look upon the heavens in wonder and in rapture and to be filled with a longing to know about them. This longing, this curiosity is worth satisfying because it has to do with the very stuff of which creation itself is made.

I like to think that there is another reason why the popular study of astronomy, as made possible by a planetarium, is worthwhile, and that is that it teaches us that everything in the universe takes place in compliance with eternal and unchanging laws. These laws are so precise and exacting that we are able to predict with absolute certainty the position of any planet at any time as seen from any spot on the earth. We know to the minute the coming of an eclipse centuries ahead and exactly in what part of the earth its totality will be present. There is no referendum, no amendment, no repeal. There is only certainty. Nothing in the laws of men is comparable to this. When a man has once grasped the import of what this means, it is difficult to see how ever again he can be other than humble, or can ever again be satisfied with anything that is half-way, or slipshod, or unworthy . . .

It seems to me, moreover, that there is a second—a philosophical—reason why Pittsburgh should have such an Institution of Popular Science . . .

I submit to you that one reason that society has not been able to advance its social controls as rapidly as some would wish, to meet the new situations created by the forward march of science and invention, is that the people at large have had an insufficient understanding of scientific progress. For too long new scientific discoveries were the prized and secret possessions of scientists who regarded popularization as vulgarization. There was for years an attitude in many scientific quarters that seemed to say that the people could not be made to understand science; and it was a little short of unethical to try to put scientific truths into plain English. Fortunately, that day is passing rapidly. Today the scientist of great achievement is sometimes one who can discover new truths and also state the matter so simply that a high school boy can understand and find challenge and inspiration in the understanding. In a democracy the source of social action is the people. It seems obvious, therefore, that if the people are called upon to take social action as a result of advances on the frontiers of science, they should have every facility to understand what these advances are, how they have been achieved, and where they may be expected to lead us.¹

The Buhl Planetarium has, during the past 18 years, established itself as a unique community-service organization. The program

¹ Dedication of the Buhl Planetarium and Institute of Popular Science, a program published by the Planetarium, Pittsburgh, Pa., Oct. 24, 1939.

developed there has been quite different from that of the other planetariums. First, the planetarium sky theater has not dominated the operation; equal emphasis has been given the exhibits and displays in the superb popular science museum. Cooperation with the schools has been carried out most extensively. The theme for a month permeates the presentation in the dome, but it also extends to the exhibits and general motif. For example, during the Latin Festival, the orientation in the planetarium is to the skies of Rome, and the Museum displays exhibits and projects prepared by Pittsburgh-area students in conjunction with their studies of the classics. School teachers are involved in the planning and implementation, and prizes are awarded to the students. The donors of the prizes include nearly every Pittsburgh manufacturer interested in science.

Unlike most of the other American planetariums, Buhl has in this manner extended its interests beyond astronomy and the natural sciences to include social science, language, engineering, etc. Probably more young people have been reached in so doing. The number of Institute visitors proportionate to the greater Pittsburgh population is higher than for the planetariums in other metropolitan centers.

MOREHEAD PLANETARIUM

The Morehead Planetarium is housed in an elegant classical-style building on the campus of the University of North Carolina at Chapel Hill, N. C. It was the gift of John M. Morehead, former Ambassador to Sweden. The building, in addition to the dome with its Zeiss projector, which was purchased from Stockholm, has a Copernican planetarium, extensive exhibit spaces, sumptuous meeting rooms, and a state dining room with all accessories.

The planetarium is used in conjunction with classes at the University, but it also provides a service to the people of North Carolina. The extent of its efficacy becomes clear in comparing the Chapel Hill population of about 10,000 to the annual attendance at the institution of about 80,000. It represents a new type of planetarium environment—a limited audience potential, a superb physical plant, and a center of campus and community activity.

During and after the second World War, the famous Zeiss plant in Jena, in the present East Zone of Germany, was diverted to other purposes than planetarium construction. For several years, projectors were not available. This situation has changed now, and both Carl Zeiss, Oberkochen, and Carl Zeiss, Jena, appear to be ready to produce planetariums to order. Construction is in progress for new installations in São Paulo, Brazil; Caracas, Venezuela; and London, England. However, during the several years in which Zeiss was out of the market, the demand for new installations was great. There was a resurgence of interest in science, abetted popularly by the

transition from fantasy to fact in the areas of rocketry and astronautics. In many institutions, money for program expansion was available, and in numerous cities, committees of interested citizens sought new public service educational agencies. More widespread travel and consequent exposure to existing planetariums whetted the appetite.

MORRISON PLANETARIUM

In San Francisco, during the latter 1940's, the decision was made to construct a planetarium. Funds were raised by the trustees of the California Academy of Sciences for the purpose, beginning with a gift of \$200,000 from the estate of Alexander F. Morrison. No planetarium instrument was available, however, so the Academy undertook to construct one in the excellent shops that had been used to repair optical and navigation instruments for the Navy during the war. Certain basic features of the Zeiss instrument were incorporated but many improvements were made. As Dr. Robert C. Miller, director of the Academy, expressed it:

This is the first planetarium that can be operated entirely automatically. While it is the intention in general to have "live" planetarium demonstrations, if the lecturer is suddenly called away by some emergency, he can flick a switch and a tape recording will take over, giving the lecture, dimming the house lights, turning on the stars, putting the planets through their proper motions in perfect synchronization with the lecture, finally bringing the daybreak and sunrise, then turning on the house lights, thanking people for listening, and inviting them to come again. Actually of course we will never leave the planetarium unattended while a show is in progress; but if a lecturer develops a bad throat the tape will come in handy.

The automatic feature is provided by a telephone-type switchboard which can be plugged in to accomplish, by a stepping relay, 250 operations in succession on cue from the tape, the cue being provided by bits of foil on the back of the tape which complete an electric circuit.

The Academy of Sciences projector is quieter in operation than earlier instruments. The hemispheres containing the star plates have been brought closer to the center, giving a better distribution of weight and improving the appearance. The planet projectors, which are light in construction, have been put at the two ends of the instrument, instead of at the "waist" as in the Zeiss design. The "eyelids" which cut off the light of the stars when they reach the horizon are more positive in operation. The moon is not just a round white disc but an actual photograph of the moon projected on the dome. The stars themselves give a greater illusion of reality. (Miller, 1952, p. 17.)

Since its opening in November 1952, the Morrison Planetarium has taken its place among the institutions of the country seeking to bring astronomical science to the general public.

SPITZ PLANETARIUM PROJECTORS

Another series of developments in the latter part of the 1940's has considerably changed the planetarium picture in the United

States. Armand N. Spitz is the man responsible. He is a self-taught astronomer with a background in newspaper work and museum education—a man with an endless stream of ideas. For years he had harbored notions of producing a planetarium that was within the means of many schools, museums, and libraries in even the small communities. In 1947, his dream became a reality; Spitz and some business friends actually produced a small functioning star projector.

The new device was a dodecahedron assembled from 12 pentagonally shaped black plastic sheets. At the center, properly gimballed, was a small electric light bulb. Rays of light shone from it through holes machined in the surface of the dodecahedron—large holes for large stars, small holes for small stars. Diurnal motion was attained by rotating the machine around an axis parallel to the earth's axis. Latitude change was produced by tilting this axis. Separate projectors were provided to demonstrate the positions of sun, moon, and planets (which could be set in advance for any given date), and to show the meridian, celestial coordinates, and the celestial triangle which is the basic problem in celestial navigation.

The author was partly responsible for the installation of one of the earliest Spitz planetariums located at the U. S. Merchant Marine Academy at Kings Point, N. Y. As an assistant professor of astronomy I was seeking a means of demonstrating the three-dimensional character of the skies in a simple and meaningful manner. I was mindful of the elegant but confusing blackboard drawings of one of my own early astronomy instructors, and was determined not to duplicate the confusion. Visits to the American Museum-Hayden Planetarium with the astronomy classes had been arranged for several years, but the demonstrations there were not specifically appropriate to the needs of our students. The visits did prove the potential value of a planetarium for our own use.

A small planetarium dome was constructed in the astronomy classroom. It was 20 feet in diameter and 13 feet high from floor to zenith; the height was fixed by the ceiling. Benches were installed to accommodate up to 30 students—a full class. As soon as the Spitz projector was supplied, classes were scheduled regularly in the planetarium—normally, about one-half of a class session each week for most of the school term, or a total of about 5 hours out of the 45 allotted for the course in descriptive astronomy. The planetarium also served as a center of interest for the Academy's astronomy club, and as a point of visitation for guests on campus.

The installation at Kings Point is typical of many others made by the Spitz organization since 1947. To date, more than 180 classroom-size units have been erected. Some are comfortably housed in separate

buildings set aside or constructed for the planetarium, and some have been installed in existing areas in schools, colleges, museums, and observatories.

The planetarium projectors in the more recent installations are superior to the earlier models. The plastic of the dodecahedron has been replaced by aluminum, and special lens-type projectors have been attached for each of the first-magnitude stars, thereby vastly improving the appearance of the artificial sky. The control console is far more comprehensive and versatile. The domes have been improved, too, and some are large enough to provide seating for more than one hundred people. Special planetarium benches were designed for the comfort of the sky-watching audiences.

But Armand Spitz was not satisfied with the smaller planetarium instruments. During 1952-53, his organization created a new projector designed to be comparable to the Zeiss. In general appearance it is similar, but there are several significant design modifications. As in the Zeiss, the stars are produced in spheres at the two extremes of the device, but in the Spitz the source of light is a unique high-intensity pin-point light source cleverly fitted to reflect light rays through the holes machined to represent the stars. The entire projector assembly is suspended from unobtrusive cables secured to the ceiling, leaving the apparently unsupported machine "floating in space" with no structure between it and the floor.

The first of the Model B projectors, as the new ones were labeled, was installed at the Centro Municipal de Divulgación Científica in Montevideo, Uruguay. Reports from that country since the 1954 opening indicate both wide public acceptance and dependable performance of the instrument.

Model B's are also being installed at the Flint College and Cultural Development in Flint, Mich., and at the U. S. Air Force Academy in Colorado Springs, Colo. Both are scheduled to be opened in 1958.

The Flint installation is unique. The planetarium is to be a part of an extensive college and community service plan that includes two special-purpose theaters, an art center, a library, a transportation museum and malls, reflecting pools, and donor memorials—all integrated in design and utility. The planetarium will be named for Robert T. Longway, one of the Flint businessmen who have been responsible for raising the funds for this extensive project.

The planetarium at the Air Force Academy, like the smaller installations at the U. S. Merchant Marine Academy, the U. S. Naval Academy, and the U. S. Coast Guard Academy, will be utilized extensively for teaching navigation and descriptive astronomy to the cadets. It will also be used as a campus attraction for visitors, thus filling the gap of major planetariums between Chicago in the east and San Francisco-Los Angeles in the west.

Meanwhile, in Boston, another planetarium has been under construction. It is a part of the Museum of Science in Science Park, and is named for Charles Hayden, the philanthropist who also donated the Zeiss projector for the planetarium in New York. The building was completed early in 1956, but the construction of the complex new projector has been delayed. It is likely that the new Hayden Planetarium will open its doors along with the ones at Flint and the Air Force Academy in 1958.

The Boston instrument is being built by Frank Korkosz at his shop in Springfield, Mass. It is a completely new, if not radical, design incorporating the advantages of both Zeiss and Spitz. In particular, the star images as projected on the dome are reported to produce an illusion much closer to reality than in the earlier instruments, though both Spitz's Model B and the California Academy of Sciences have been successful in attaining actual variable intensity in their star representation, as opposed to the variable-sized disks in the Zeiss and Spitz classroom units.

While awaiting the delivery of the new projector, the staff in Boston has been able to create several new and different special effects: A lighted skyline that drops into the cove below horizon level, remarkably realistic lightning, and a sound system sufficiently versatile to reproduce most any sound effect in whatever location in the dome might be specified.

Many other planetarium installations are on the drawing boards. Most of these will be the small classroom-size Spitz; there may be several large ones, too. Seattle, Portland, Detroit, St. Louis, Dallas, Kansas City, Miami, and Washington are among the cities from which there are indications of interest. The time may not be far distant when planetariums will be as numerous as museums. In this age of emphasis on science, such a trend is not only welcome, but almost mandatory.

BIBLIOGRAPHY

BUTLER, HOWARD RUSSELL.

1926. An ideal astronomic hall. *Nat. Hist.*, July-August, pp. 393-398.

FAUNCE, WAYNE M.

1935. Problems of construction. *Nat. Hist.*, October, pp. 207-216.

FISHER, CLYDE.

1926. The new projection planetarium. *Nat. Hist.*, April, pp. 402-416.

FOX, PHILIP.

1932. The Adler Planetarium and Astronomical Museum of Chicago. *Pop. Astron.*, vol. 40, pp. 125-155.

INGALLS, ALBERT G.

1929. Canned astronomy. *Sci. Amer.*, vol. 141, pp. 201-204.

KAEMPFERT, WALDEMAR.

1923. Now America will have a planetarium. *New York Times Mag.*, June 24, pp. 4-5, 21.

LEWIS, CHARLES F.

1939. Address at dedication of the Buhl Planetarium and Institute of Popular Science. Program of the Dedication Ceremony, Pittsburgh, October 24, pp. 17-19.

MILLER, ROBERT CUNNINGHAM.

1952. Galaxy by the Golden Gate. Pacific Discovery, Special Morrison Planetarium number, December, pp. 11-17.

SPENCER, STEVEN M.

1954. The stars are his playthings. Saturday Eve. Post, vol. 226, pp. 42-43, Apr. 24.

STOKLEY, JAMES.

1937. Planetarium operation. Sci. Month., vol. 45, pp. 307-316.

VILLIGER, DR. W.

1926. The Zeiss Planetarium. Pp. 14-17, London.

WERNER, HELMUT.

1957. From the Aratus Globe to the Zeiss Planetarium. Pp. 9-26, 49-54. Stuttgart.

PAMPHLETS

The Hayden Planetarium. American Museum of Natural History, 1937.

A report to members. Museum of Science, Boston, Mass., November 1952.

Catalog of Flint College Junior College, Flint, Mich., June 1957.

Spitz Planetariums. Spitz Laboratories, Inc., Yorklyn, Del., 1957.

The story of the Griffith Observatory and Planetarium. Board of Recreation and Park Commissioners, City of Los Angeles. (No date.)

Reprints of the various articles in this Report may be obtained, as long as the supply lasts, on request addressed to the Editorial and Publications Division, Smithsonian Institution, Washington 25, D. C.



1. An attempt to represent the Egyptian Universe. "The Dawn of Civilization," by Gaston Maspero.

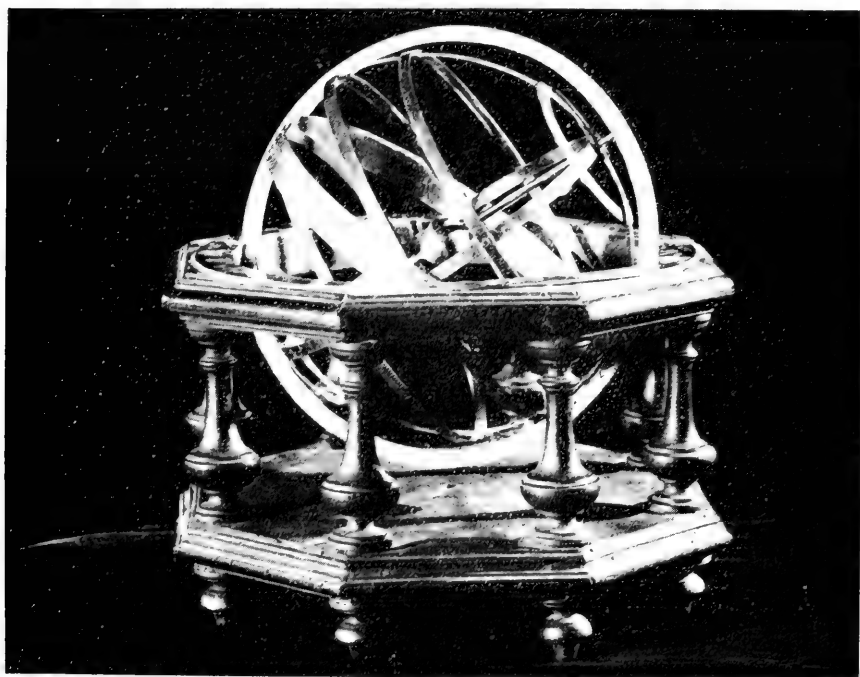

2. A forerunner of the planetarium—an Italian armillary sphere dating from about 1550. The wooden support is more recent. American Museum-Hayden Planetarium, New York City.



The Griffith Observatory and Planetarium in Griffith Park, Los Angeles. The planetarium dome is the larger one on the left, and the Zeiss telescope is housed in the smaller dome to the right.

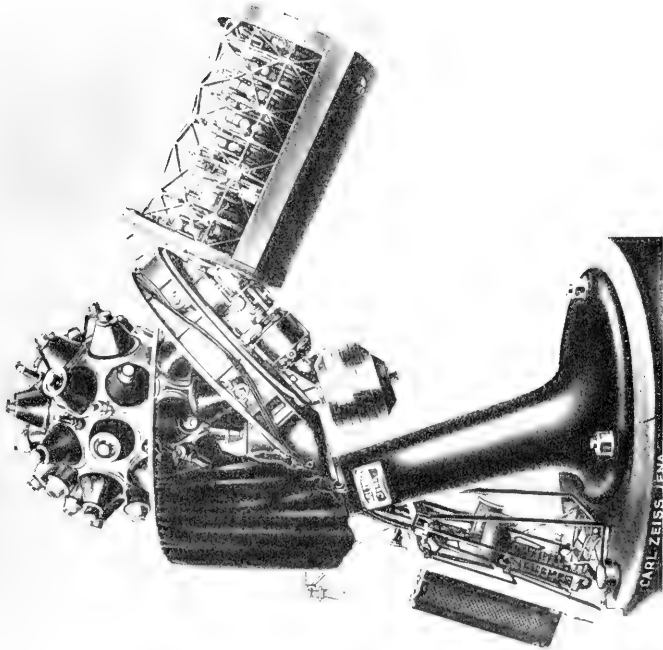

1. Projection apparatus of the Carl Zeiss Jena Planetarium.

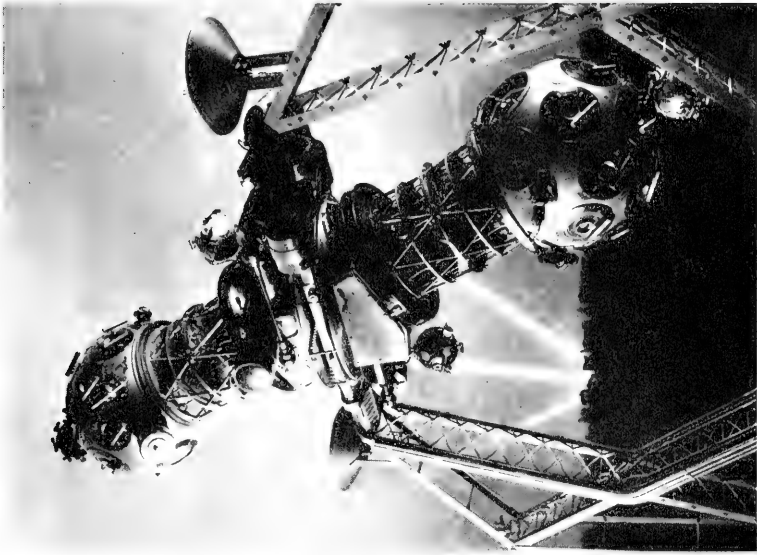

2. Zeiss Optical Planetarium projector in the American Museum-Hayden Planetarium, New York City.

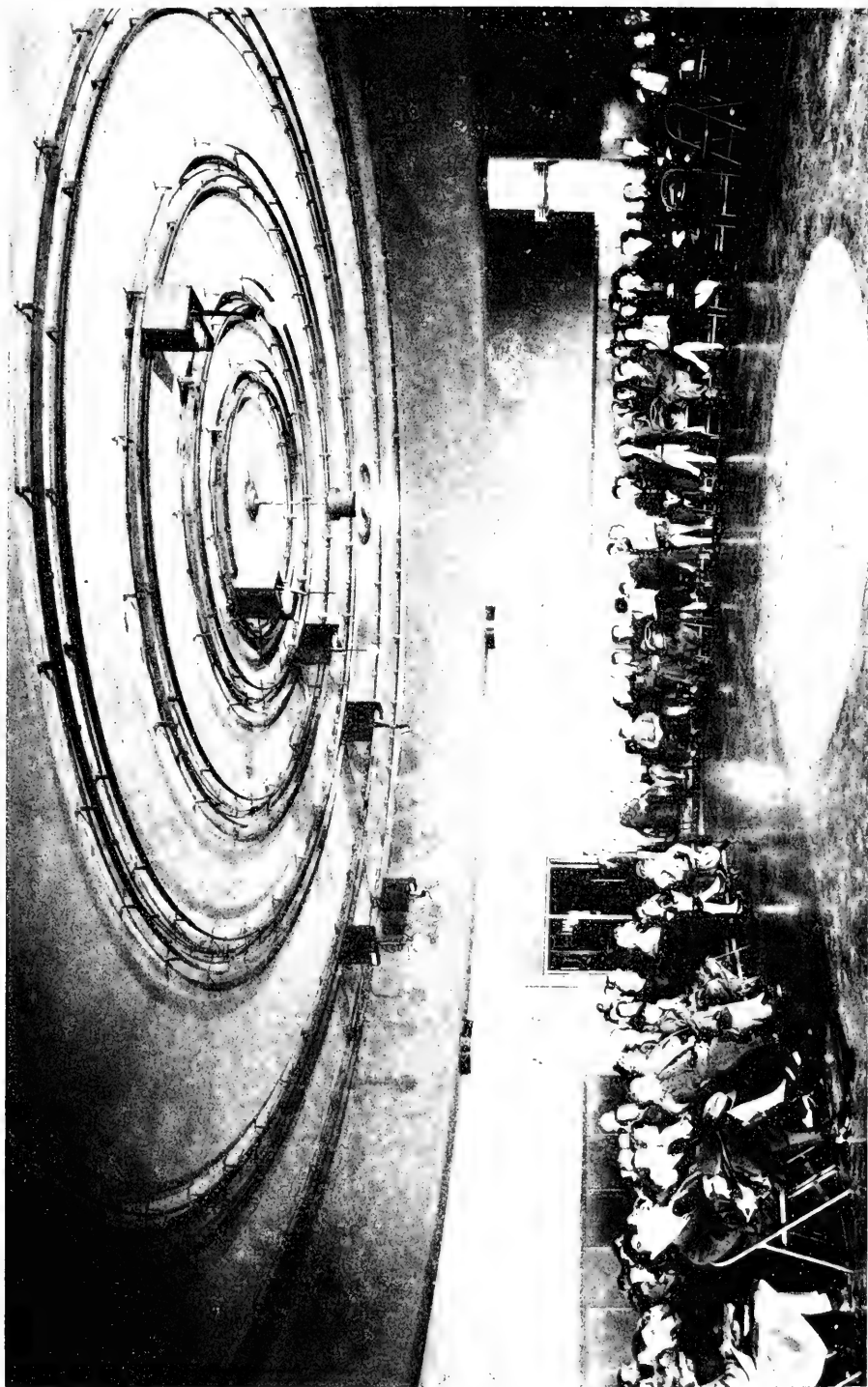

The Copernican Planetarium in the American Museum-Hayden Planetarium, New York City. There is a duplicate in the Morehead Planetarium and it is similar to the one in Deutsches Museum in Munich.

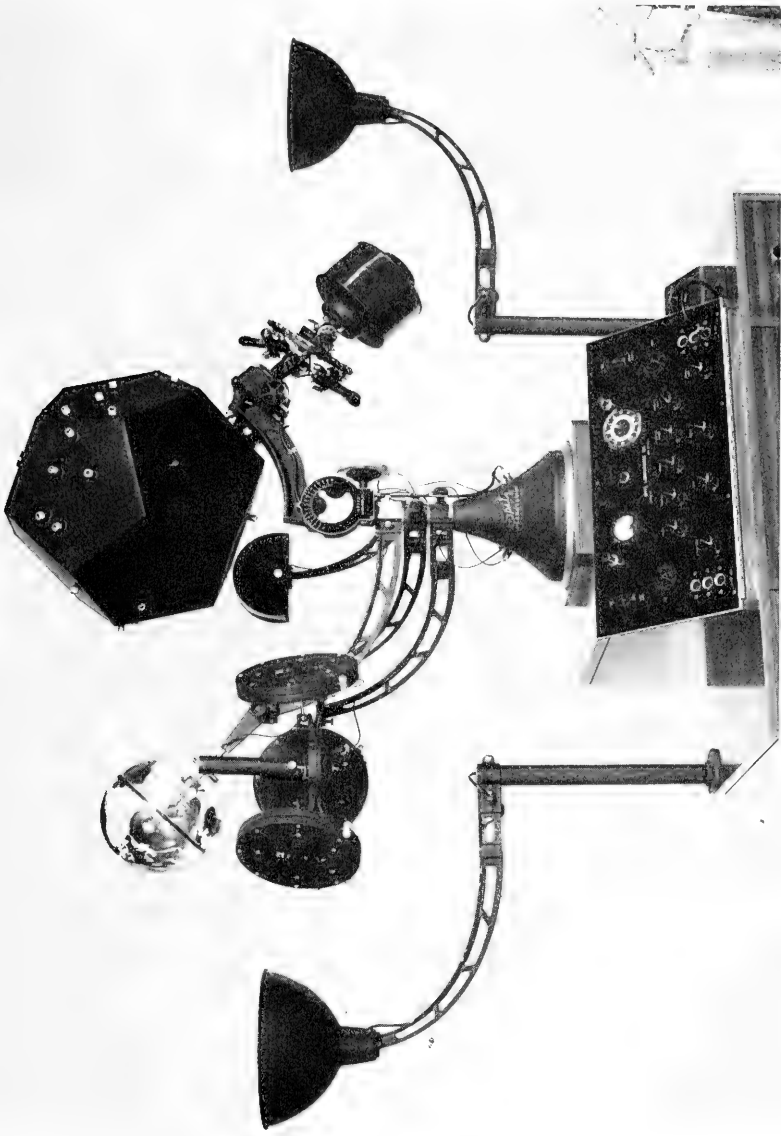

The standard Spitz Planetarium, with its auxiliary educational projectors, now in use in more than 150 schools, museums, municipalities, and military colleges all over the world.

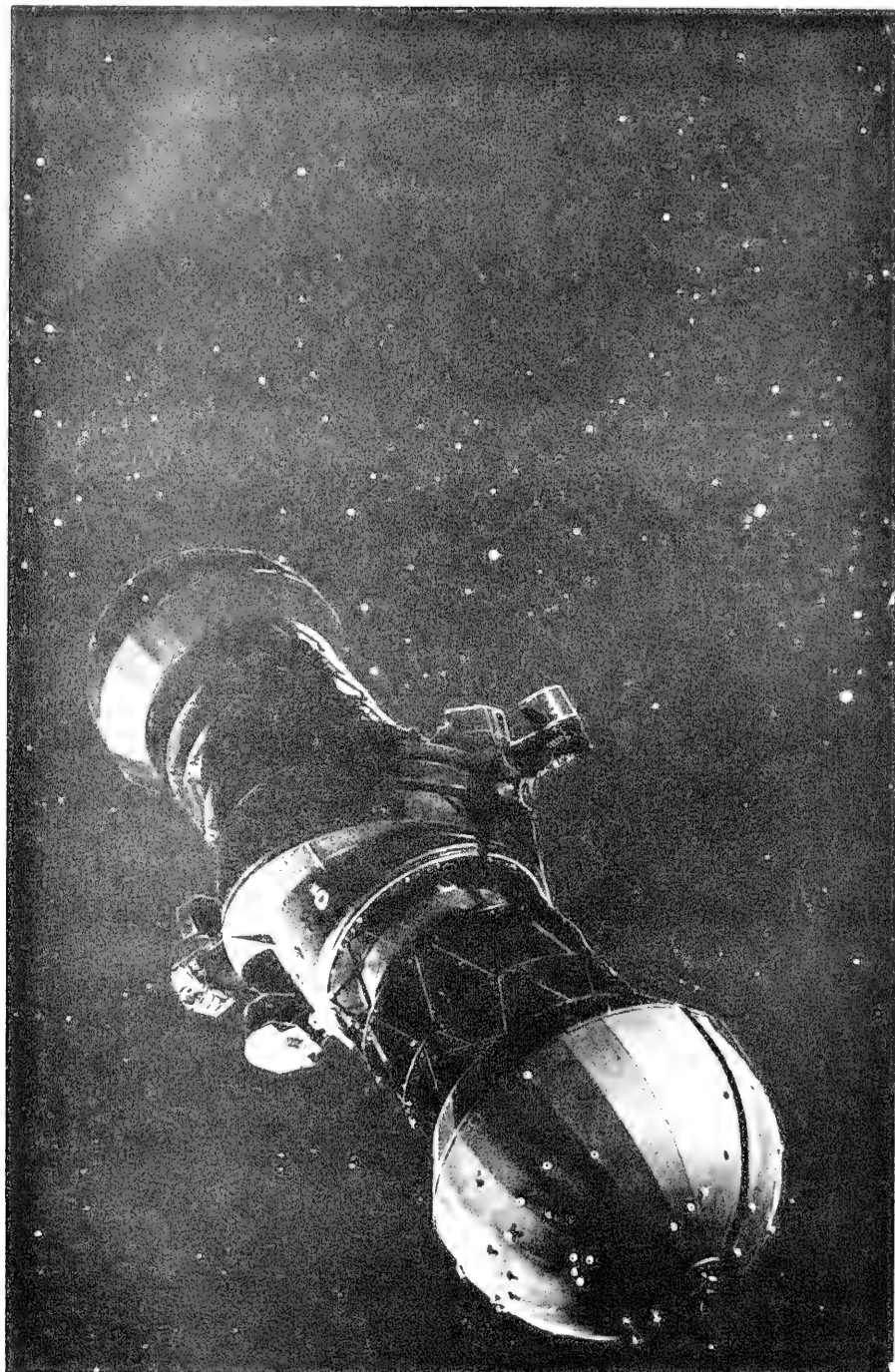

The major Spitz Planetarium, suspended from the domed ceiling, projects Southern Hemisphere stars as seen from Centro Municipal de la Divulgación Científica in Montevideo, Uruguay. Similar instruments are to be found at the Flint, Mich., Educational and Cultural Center, and at the new United States Air Force Academy in Colorado.

The Development of Radio Astronomy¹

By GERALD S. HAWKINS

*Director, Boston University Observatory
Research Associate
Harvard College Observatory*

[With two plates]

IT IS NOT OFTEN that we can witness the birth and development of a new science such as radio astronomy. Most sciences have had obscure beginnings, and the world has been slow to realize their importance. Astronomy, for example, began with an interest in the stars and the motion of planets long before the beginning of recorded history, but this interest could not develop into a science until after the invention of arabic numerals, which paved the way for the theories of planetary motion several hundred years later. The telescope gave a great impetus to research when in 1609 Galileo discovered the moons of Jupiter and Saturn's rings, but knowledge spread slowly in those days and it took more than 200 years to establish the basic facts of astronomy. We know that the sun is one star among 100 billion in the local galaxy, and in the universe there are probably more than 100 billion other galaxies. With the additional techniques of photography and spectroscopy rapid advances are being made in all fields, so that we can study the atmosphere of the planets, the composition of the stars, and can investigate almost any problem we choose.

On the other hand, the science of radio astronomy has developed at a time when the world seems to be almost at the peak of its technical evolution. The radio sky was first glimpsed by Jansky in 1932. Within 15 years the significance of the new science was realized and then discovery followed discovery with bewildering speed. Radio stars were found, some of which are quite invisible to the astronomer, and others which are coincident with exploding stars and with galaxies in collision. Spiral arms have been mapped out in our local

¹ Reprinted by permission from *American Scientist*, vol. 45, No. 1, January 1957, copyrighted 1956 by the Society of the Sigma Xi.

galaxy and radio signals have been detected from the neighboring galaxies in the universe. Nearer home, the sun, Jupiter, and even Venus have been found to be powerful radio emitters. The cause of these signals and the nature of the invisible stars are unknown, and much research effort is being expended at the present time to solve these mysteries.

THE EQUIPMENT USED BY RADIO ASTRONOMERS

Almost every observation so far has been made with the equipment shown schematically in figure 1. Signals are picked up from space by the radio telescope to be magnified in the receiver and fed to a suitable display unit.

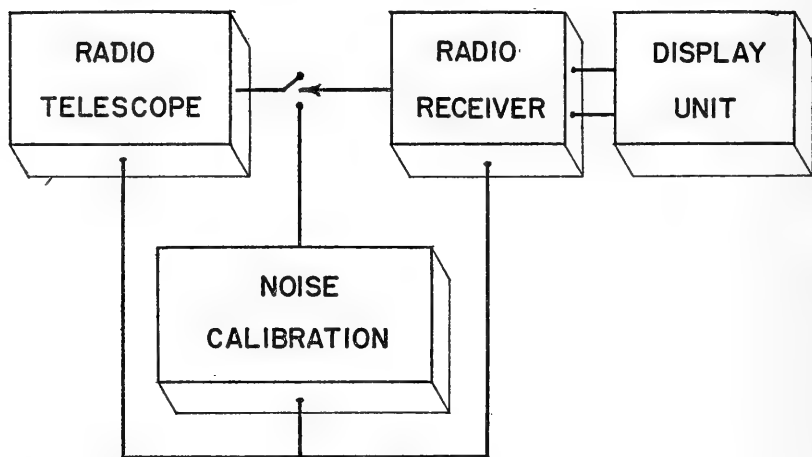

FIGURE 1.—The equipment used by radio astronomers.

Radio telescopes fall into two categories, those with a single directional beam and those with multiple beams. A single beam is formed by the parabolic reflector, as shown in plate 1, which acts like an auto headlight in reverse. Waves from a radio star are focused by the paraboloid to form a spotlike image which has a diameter inversely proportional to the aperture of the telescope. Large apertures are expensive and one of the best images that has so far been obtained is $\frac{1}{2}$ degree, given by the new 60-foot disk at Harvard. This emphasizes the main disadvantage of radio telescopes; the definition is extremely poor, not even as good as that of the human eye, but as we shall see later there are ways of overcoming this defect. At the focus of the paraboloid the image is allowed to fall on a dipole element which is formed from two metal rods similar to one side of an H-shaped TV antenna. Electric voltages and currents are induced in the dipole and are fed down a cable into the receiver.

A single beam may be produced in an endless number of ways which can become almost as complicated as the character of the designer. If dipoles are connected together to cover a flat area they are equivalent to a paraboloid telescope of the same area. The array of dipoles, however, will operate only over a narrow band of wavelengths and it is difficult to point the sensitive beam to various parts of the sky. A dipole may have five or more focusing rods placed in front of it to form a Yagi-type antenna which is frequently seen in use with short-wavelength TV receivers. Electrical energy may also be picked up on a long metal helix. Both the Yagi and helix are equivalent to paraboloids with apertures of from 1 to 2 wavelengths.

It is possible to increase the quality of the image by means of the interferometer. Two separate antennas are spaced at either end of a long baseline and the signals are mixed together in the receiver. A radio star perpendicular to the baseline produces signals that are in phase at each antenna. As the earth rotates and the radio star makes an angle with the baseline the signals will differ in phase and tend to cancel out. In this way a radio star produces periodic variations as it rises, passes due south, and sets. Now the effective aperture of the telescope is equal to the length of the baseline, so that a narrow beam can be produced with reasonable economy. Unfortunately, not one but many narrow beams are produced, so that the results become difficult to interpret. Despite this limitation, however, the interferometer has done much valuable work in determining the angular diameter and exact positions of radio stars.

The receiver is similar in many respects to those used in TV, except that the voltage gain is high (~ 10 million) so that the radio noise due to thermal motion of electrons at the input of the receiver is readily detected. In radio astronomy great care has to be taken to maintain a constant gain in the receiver because a fluctuation, say in the temperature of the filaments in the tubes, would produce a variation of noise at the output which would mask the faint signals being detected from space. A standard source of energy is put in the place of the telescope to calibrate the receiver as shown in figure 1. This is usually a diode vacuum tube since the noise power is accurately known in terms of the current flowing through the tube. To minimize the effect of variations in the thermal noise of the receiver the calibration is sometimes carried out automatically at a rate of 25 times per second. In this way a 25-cycle note is produced at the output and the amplitude of the note is independent of receiver noise, being proportional to the difference between the cosmic signal and the standard source. There will always be slight ripples in the output, however, even with an ideal system, because we are comparing two noise signals which

are varying in a random manner about a certain mean level. These ripples can be greatly reduced by integrating the signals over long periods of time.

One of the most impressive ways of displaying the noise from the cosmos is to use a loudspeaker system. The sun and local galaxy can be heard as a gentle hiss; the galactic noise remains steady but the storms on the sun swell and fade many times during the course of an hour. Jupiter is the performer that really dominates the air. When heard over a high-fidelity system, its roars and rumbles almost convince one that the Romans were right in their ideas about the gods. For quantitative work, however, it is essential to obtain a permanent record in a form amenable to analysis. If the signal is fed to a

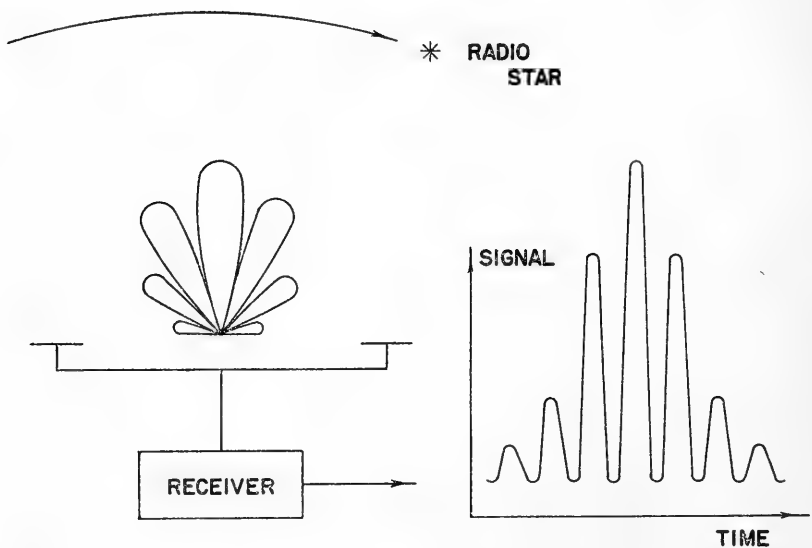

FIGURE 2.—A radio interferometer and the signal it produces when a radio star passes through the antenna pattern.

millimeter with a pen attached to the arm, a mark will be made which is proportional to the intensity of the signal. If the mark is made on a roll of paper driven at a constant speed then a precise intensity-time graph is produced. Radio stars can be observed by sweeping the telescope slowly across the sky, for when the star is in the center of the beam the pen gives a maximum deflection. One of the most convenient scanning arrangements is to clamp the telescope and utilize the rotation of the earth. This has been the preferred method with an interferometer because the baseline is long and the instrument is mechanically unwieldy. The sensitive beams are therefore allowed to drift across a star as the earth rotates and the pen record varies rhythmically as shown in figure 2. A star of small diameter produces well-defined maxima and minima, but a large

source forms an indistinct pattern. The depth of the minima gives a measure of the diameter of the radio object. In specialized work, following the rapid movements of gas jets across the sun for example, the interferometer beam has been made to scan at a fast rate but the method presents practical difficulties and is not often used. The scanning is performed electrically by introducing a variable phase lag in the cable from one of the antennas.

SIGNALS FROM THE SUN

There are remarkable differences in the appearance of the sun at different radio wavelengths. Optically we see down through the solar atmosphere to the incandescent layer of gas called the photosphere. This layer is at an average temperature of 6200°C ., but occasionally large areas become cooled to about 5000°C . and a dark sunspot appears. Sunspot regions are greatly disturbed and have been likened to storms. Ciné films show that part of the interior of the sun is disgorged to rain down incessantly as streams of white-hot gas. The whole area is pierced by an intense magnetic field which probably has its origin in whirlpool motions below the photosphere. Sometimes a bright flare of light appears near a spot, as shown in figure 3, and this is thought to mark the ejection of a stream of charged particles which impinge on the atmosphere of the earth a day or so later, causing beautiful displays of the Aurora Borealis. Above the photosphere we find the chromosphere, which is a red-colored layer about 10,000 km. thick, visible during a total eclipse of the sun. During an eclipse a white halo is also seen extending outward for about a solar radius. This is the solar corona, an envelope of ionized gas shining with scattered sunlight. It has recently been shown that the outer edge corona is at a temperature of a million degrees; this is a helpful clue in explaining some of the peculiar radio effects that have been observed at long wavelengths.

At centimetric wavelengths the sun looks very much the same as it does in the optical band, except that the steady light is now able to pass freely through heavy cloud, rain, or fog. At wavelengths of 20 cm. the sun ceases to be uniformly bright but develops a ringlike halo. Viewed with radio eyes it would appear as a brilliant circle with a dusky center. This is caused by the temperature inversion in the corona where the temperature increases as we move out from the sun. Looking at the center we see the cooler layers below, and looking at the limb we see the hotter layers edge-on. In addition to the limb brightening, starlike points appear on the disc of the sun and contribute to the general radiation. It has been shown that these points occur near the visual sunspots, so at 20 cm. the radio astronomer has a completely reversed image, a dark sun with bright sunspots.

There were further surprises in store for the radio astronomer when he looked at the sun at wavelengths of about 1 meter. A steady signal was observed corresponding to a temperature of a million degrees. To find the exact location of the noise source on the sun an attempt was made to observe an eclipse. Providence has so arranged the distances of the earth, moon, and sun that the circular shape of the moon exactly covers the photosphere. Without this fortunate coincidence our knowledge of the sun would for a long while have been quite

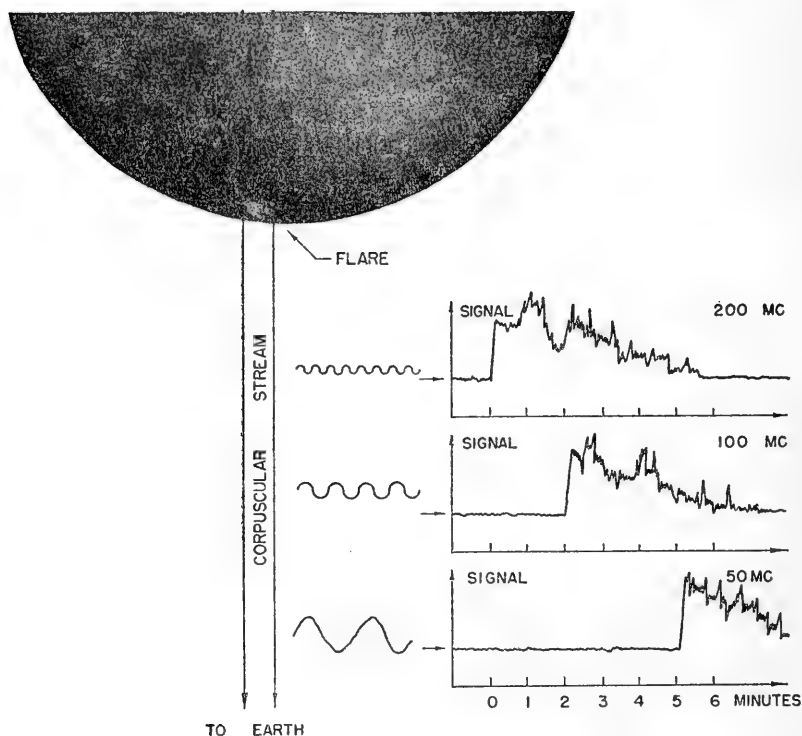

FIGURE 3.—Radio signals produced by a corpuscular stream as it travels through the atmosphere of the sun. (Photograph taken at the Astrophysical Observatory, Kodai-kanal, India.)

sparse. As the moon gradually covered the solar disc it was hoped that the radio signal would disappear at a certain stage of the eclipse and thus reveal the radio source. The observations showed little variation in the signal and even at totality the radio sun was still shining. It was obvious that the radio sun was much larger than the optical, and the radiation was coming from the high corona.

Three types of major radio disturbances are recognized as emanating from the sun. They are noise storms, outbursts, and bursts. A noise storm originates in a cloud in the corona, vertically above a sun-

spot. The cloud is invisible optically, but on radio wavelengths it shows temperatures of billions of degrees. The enhancement of radio emission may continue for several days, and during periods of sun-spot activity noise storms occur once every five days on the average. If the sun were to behave in the visible spectrum as it does at radio wavelengths the world would have been burnt to a cinder long ago. One of the most spectacular phenomena is the noise outburst which occurs after a solar flare. The flare is usually accompanied by an upward surge of hot gas which leaves the chromosphere with a velocity of about 100 km. per second and then falls back again into the sun. An intense radio source, associated with the surge, moves outward with a velocity of the order of 2,000 km. per second. This movement has been followed in a number of surges with the rapid scanning interferometer and there is evidence that the radio source does not fall back again but leaves the sun completely as a corpuscular stream of electrons and positive ions. As the stream forces its way through the ionized layers in the corona it is able to emit radiation of increasing wavelength. Three receivers would therefore detect the noise one after the other as shown in the records of figure 3. After a time lapse of about 24 hours the corpuscular stream reaches the earth and excites the atmosphere to make it glow with the beautiful colors and forms of the aurora. A portion of the sun has been presented with majestic pomp to the earth.

RADIO STARS

For many years the astronomer, with modest pride, has felt that he could count with certainty the number of bright stars in the sky. There are many, however, that he would have overlooked because they are invisible optically. Provisionally, these objects are called radio stars but it is certain that most of them are quite different from the stars of optical astronomy. The brightest radio star is in the constellation of Cassiopeia. It corresponds in position with one of the faintest nebulae that can be detected with the 200-inch telescope on Mt. Palomar. The nebula was found only after repeated searching near the radio position and it would probably have remained undetected if the radio data had not been available. So far the nature of the object is a mystery. Spectroscopic evidence shows that it is an irregular cloud of gas with violent internal motions and high excitations. The object is known to be within our local galaxy but opinion is divided as to whether the gas is dispersing or condensing, possibly to form a new star.

Cygnus A is the second brightest radio star. It corresponds to an object at a distance of 2×10^{21} km., a distance so great that its light and radio waves take 200 million years to reach us. *Homo sapiens* was

certainly not in existence when the radio waves we receive now started on their journey. It is fortunate that the object was not at any greater distance for it would then have been beyond the limits of the visible universe as seen with the Palomar telescope. By careful photography the telescope shows that a remarkable catastrophe is taking place out there. Two galaxies, two huge systems of stars and gas, are involved in a collision. Plate 2, figure 1, shows the galaxies in contact, but it is difficult to imagine that the spots and surrounding halo actually represent a cloud of stars some 3×10^{17} km. across. Collisions of this kind are extremely rare and we would probably have to see well beyond our present range before we found another face-to-face contact like that in Cygnus A. The consequences of galactic collisions have already been studied. Remarkably enough, the stars in the system are hardly affected at all; interstellar distances are so great that the star systems can pass through each other with only minor perturbations. The gas between the stars, however, meets with great violence. Part of the kinetic energy of the collision is emitted as radio waves; indeed, the process is extremely efficient, about 5 percent of the energy being converted in this way. It seems that collision and violent motion in gas clouds are an essential requirement for the formation of a radio source. Cassiopeia A contains gaseous filaments in rapid motion, Cygnus A is formed by gas clouds in collision, and we shall see that other radio stars are associated with this condition. It has probably taken a million years or so for the galaxies to pass through each other. Bearing in mind the fact that light takes 200 million years for the journey, we realize that the actual collision process must have been completed long ago and there will now be left two remarkable galaxies in space cleared of dust and gas, while between them will be a hot gaseous nebula, far larger than any that we encounter in the local galaxy. But these objects will not be visible to astronomers until a million years have passed.

There is one radio star that was observed in A. D. 1054, 12 years before William the Conqueror landed in England. In this year a star in the constellation of Taurus, the Bull, exploded, leaving an object which we now call the Crab nebula. The sudden increase in brightness was seen by Chinese astronomers who faithfully noted the event in their records and stated that the new star was visible by day as well as by night. According to modern terminology this was a supernova. Research shows that about once every 500 years in our galaxy a star reaches an unstable point in its evolution, whereupon the whole star explodes like a giant atomic bomb. The disintegration is complete and all that remains is an expanding ball of gas. Astronomers have checked the rate of expansion spectroscopically and also by taking photographs spaced many years apart. On extrapolating



The 60-foot George R. Agassiz radio telescope. (Photograph by Robert E. Cox, with permission of Sky and Telescope.)

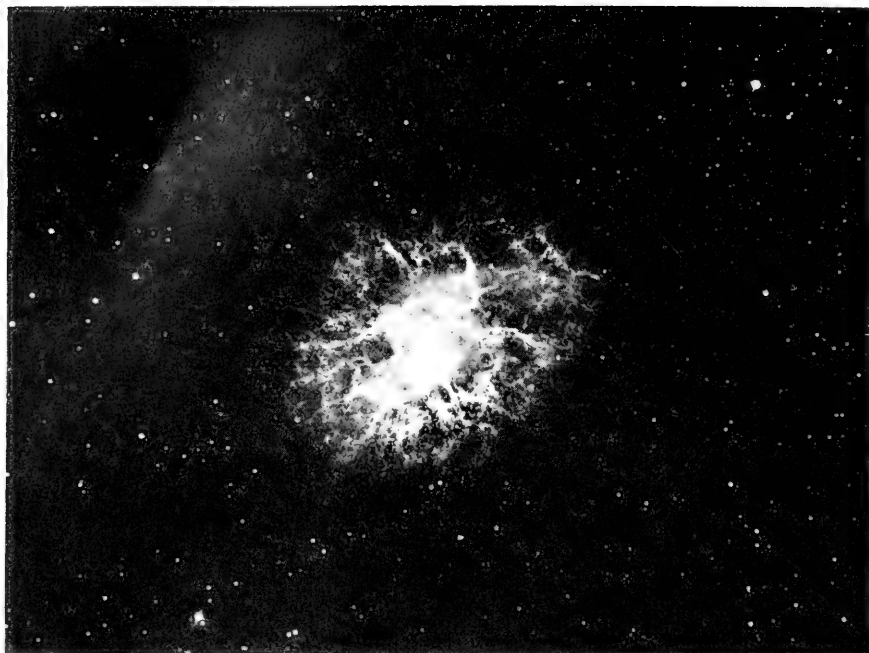

2. The Crab nebula photographed in hydrogen light. (Photograph by permission of Mount Wilson and Palomar Observatories.)

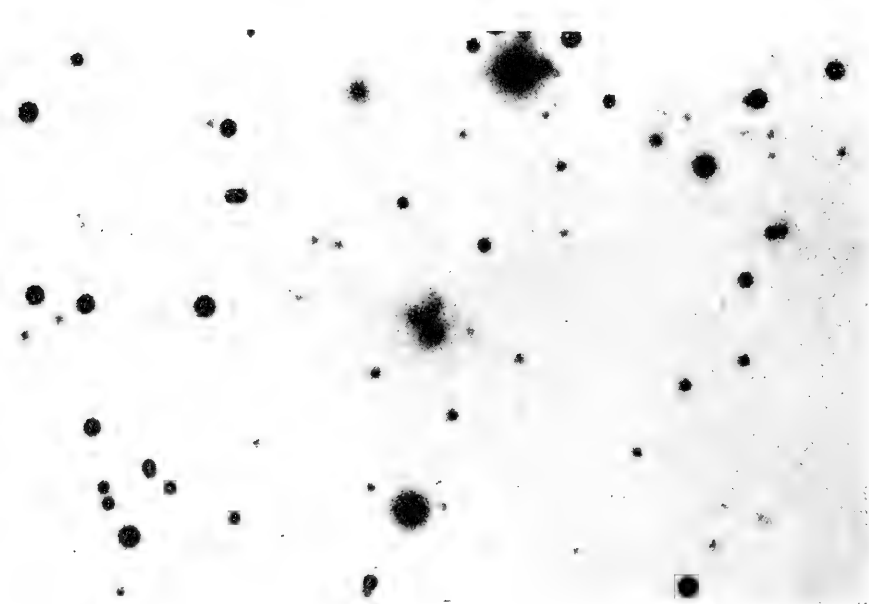

1. Galaxies in collision. (Photograph by permission of Mount Wilson and Palomar Observatories.)

back, they find that the ball was a single point in the year 1054, thus confirming the identification. When the Crab nebula is photographed in the red light of hydrogen, as in plate 2, figure 2, we notice a filamentary structure and it is clear that the nebula is in a violent state of motion. The expansion of gas again acts as an efficient generator of radio waves, although the exact process is still obscure. Interferometer measurements show that the whole of the visible nebula is transmitting, and the radio image fits almost exactly over the photographic image. Another supernova was observed by the famous astronomer Tycho Brahé in 1572, and this too has been identified as a radio star. The last supernova was recorded by Kepler in 1604, so that if the estimated mean rate of one supernova every 500 years or so is correct, there is a high probability that a supernova will occur in our time. This would present a unique opportunity for studying the entire process with all the superb equipment available to the modern scientist.

These three sources in Cassiopeia, Cygnus, and Taurus are among the few radio stars to have been positively identified. Recently a catalog of over 1,900 radio stars was made and the astronomical nature of most of them is still unknown. Much research will obviously be required before this mounting list of mysteries can be solved.

THE MILKY WAY

The original observations of Jansky in 1932 were made on the Milky Way, our local galaxy. Radio interference was found which seemed to be coming from the galactic center. Surveys of the sky have since been made in great detail with wavelengths ranging from a few centimeters up to many meters. The radiation comes from a large elliptical area which is aligned with the general direction of the Milky Way. Optically there are dark obscuring clouds or lanes of dust, but these do not appear on the radio maps because the radio waves pass through them. Dark clouds obscure the center of the galaxy, which is probably the most interesting part, but this region is easily visible to the radio astronomer. So far very little research has been done on the galactic center and this remains an exciting field for the future.

It is not known yet whether the general galactic noise is the combined signal from millions of radio stars or whether it originates in the matter between the stars. In a few years time, when large radio telescopes are available, it may be possible to see if myriads of faint stars are producing the noise. Meanwhile much speculation goes on as to the exact origin of the signals.

There is one component in the radio spectrum, however, that is well understood. Radiation has been detected over a small waveband at 21

cm. This emission line is produced by the neutral hydrogen atom. If the spins of the proton and electron are aligned in the same direction there is a tendency for one of the spins to change. The probability of the change is very low so that a hydrogen atom waits several million years before changing. At this time it emits 9.4×10^{-25} joules at a frequency of 1,420 mc. Although this seems an insignificant power output, the number of atoms in the direction of the antenna beam is usually sufficient to give a detectable signal. The signal strength gives a measure of the temperature and space density of the hydrogen, but, what is more important, the exact frequency of the emission gives the velocity in the line of sight. As in the case of sound waves and light waves, the observed frequency of a source is higher when it is approaching and lower when it is receding so that the velocity of the source can be found. By measuring the velocity of the hydrogen with respect to the sun the astronomer is able to go one step farther. The galaxy is rotating about its center and each star follows an orbit which is nearly circular. Stars on the edge of the galaxy travel more slowly than stars near the center. Hence a measure of velocity gives a measure of the distance of a hydrogen cloud from the galactic center and the position of hydrogen in space can be deduced.

Extensive surveys at 1,420 mc. have been made. It is found that the neutral hydrogen is concentrated within the spiral arms of our galaxy. By means of the hydrogen emission these arms may be traced out far beyond the optical limit which is set by interstellar absorption. For the first time we can picture the sun as it is set in one arm of a great spiral system as shown in figure 4.

The hydrogen line has been detected in other galaxies besides our own. Recently emission was received from the great cluster of galaxies in Coma Berenices at a frequency of 1,387 mc. Thus the radio signal is at a lower frequency, or reddened, by the velocity of recession of the cluster in the same way that the visible spectrum is shifted. Absorption by hydrogen has also been noted in the noise from the colliding galaxies in Cygnus. Again there is a shift of the radio line which corresponds to the red shift observed optically.

JUPITER

It is scarcely a year since the radio signals from Jupiter were discovered. Many tape recordings have already been made which illustrate the effects that this planet can produce. There are components of the hissing sound which are usually associated with the random motion of thermal electrons. It is unlikely that the noise is really thermal in origin because it is difficult to visualize how high temperatures could be produced on Jupiter. The atmosphere is com-

posed of methane and ammonia and contains clouds at a temperature of -140°C. , while the planet itself is presumed to be formed of solid ices, again at a low temperature. Other noises that have been recognized are grinding sounds and rumbles. When analyzed in detail these sounds are apparently composed of a series of two or three pulses following one another in rapid succession.

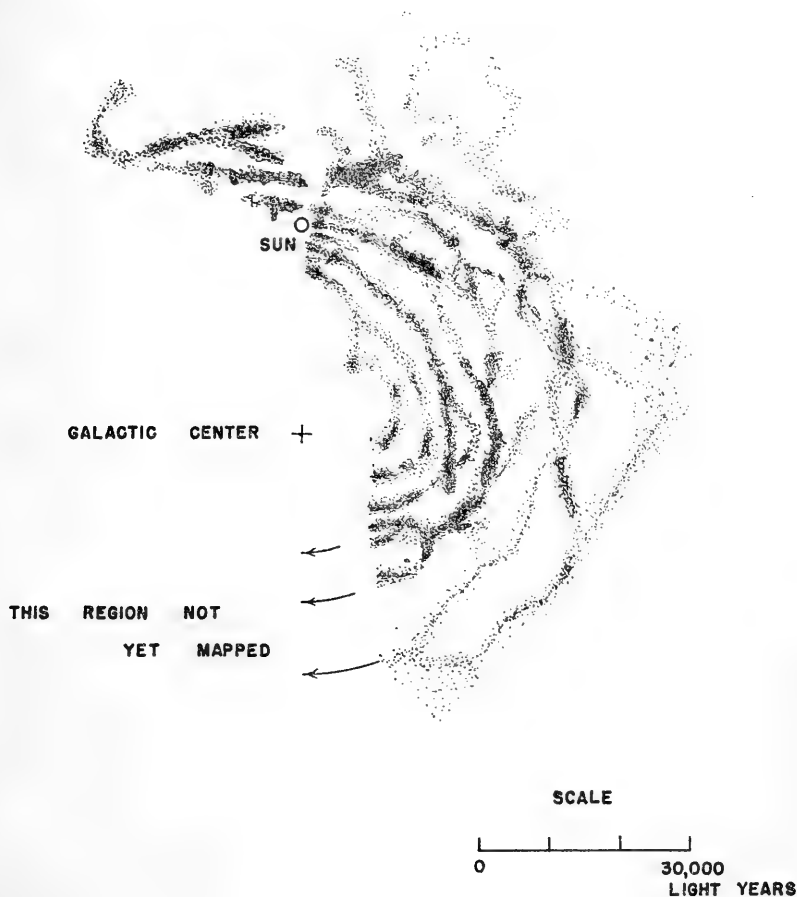

FIGURE 4.—Spiral structure of the local galaxy. (Reproduced by permission of G. Westenhout and M. Schmidt, Leiden, Holland.)

By an ingenious method it has been found possible to locate the area which is generating the noise. The transmission is spasmodic, some days it is present, other days it is absent, but by observing over long periods of time the noise has been found to vary in synchronism with the rotation of the planet. This defines a north-south line, or line of Jovian longitude on which the source lies. The planet's speed of rotation, as given by observations of clouds in the atmosphere,

varies between the Equator and the Poles. The Equator rotates once in 9 hours 50 minutes 26 seconds, and the corresponding figure at the Pole is 9 hours 55 minutes 24 seconds. By timing the variation of the signals the latitude of the source can be obtained. This is, of course, not a very exact determination, and the method is further complicated by the presence of more than one transmitting area. Despite these difficulties the main noise area has already been located. It is close to the famous red spot which has been observed in Jupiter's atmosphere since 1664. Surprisingly little is known about the spot from the optical observations. One hypothesis suggests that it is an island of solid ammonia or methane floating in the dense atmosphere, while at the other extreme it is considered to be the product of an active volcano. Perhaps the radio observations will help us to determine the true nature of this disturbance.

Radio observations have given indications that Jupiter may be surrounded by an ionosphere. The red-spot region does not produce signals at every position as it rotates. There appears to be an attenuation of the noise as the spot approaches the east or west limb and this has been explained by reflection effects in the ionosphere. The double and triple pulses forming the rumble are also explained in terms of the ionosphere. A signal from some disturbance in the atmosphere is received by direct transmission to produce the first pulse, while the second pulse is the echo produced by the surface of Jupiter. The third component is reflected from the ionosphere back to the surface before reaching the receiver on the earth.

RADAR ASTRONOMY

We are not limited to passive reception of signals. Great advances were made during the Second World War in the detection of aircraft by means of radio echoes. In the same way a high-power transmitter can be made to send out a series of pulses which will be reflected off celestial objects.

Meteors are the nearest bodies of interest in astronomy, for although they spend many years circulating between the planets, they spend the last second of their life in the atmosphere of the earth about 60 miles up. The meteor particle collides with the atmosphere at such a high velocity that it completely evaporates, producing heat, light, and ionization. By studying the echoes from the column of ionization it is possible to measure the velocity of the meteor with fair precision. With three or more radar stations one can determine the direction of motion of the meteor. Velocity and direction together define its orbit, or life history, and we can then trace back its path among the planets. Radar observations have shown that meteors are members of the solar system and do not come from the space between the stars. We now

believe that meteor fragments are shed by a comet as the icy nucleus of the comet evaporates in the heat from the sun.

Farther out from the earth we come to the moon, and radio echoes have been obtained from the moon by many experimenters. At a distance of 200,000 miles, radar astronomers have to wait for a period of about 2 seconds before the echo returns. The echo is subjected to many effects on its journey to and from the moon and from the way it has changed we can learn many interesting things about the atmosphere of the earth and the surface of the moon. The radio wave forming the echo is formed, of course, from oscillatory electric and magnetic fields which are at right angles to each other. When the electric field is parallel to the receiving dipole a maximum signal is produced. In this way the direction of the field can be determined. It is found that the field is rotated many times as the echo pulse travels to the moon and back. Most of the rotation occurs in the ionosphere of the earth, as it is proportional to the electron density of the transmitting medium and the strength of the magnetic field of the earth. This rotation gives us information about the ionosphere at great heights above the earth's surface.

As the radio pulse is reflected from the surface of the moon the mountain ranges and craters cause interference so that the echo power fluctuates. This effect is not unlike the glitter that is seen when light falls on a rough, shiny object. There are other things that cause the signal to fluctuate more rapidly than the interference from a rough surface, but the origin of these rapid variations is at present unknown.

Radar astronomy will probably never become as spectacular as radio astronomy. With pulse techniques we certainly are making our first venture out into space, and the radio pulse can certainly visit and explore the moon even if mankind at present is limited to the earth. But we will require tremendously powerful transmitters if we are to bounce an echo off our neighboring planets such as Venus and Mars. To reach the nearest star is impossible: even if we did have sufficient transmitter power we would have to wait eight whole years for the echo to return. The output of the natural transmitters of the cosmos is far greater than any we can make on the earth. Cygnus A, for example, on the edge of the visible universe, puts out a power which is more than a billion times greater than our man-made signals. Such considerations help us to realize our insignificant position as earth-bound mortals, and impress upon us the grandeur of the natural universe.

Jet Streams¹

By R. LEE

*Meteorological Service of Canada
Department of Transport*

[With one plate]

INTRODUCTION

ON April 1, 1954, three United States Navy F-9F fighters streaked across the United States on a cross-country flight. The lead plane of the trio unofficially broke the speed record with a flight time of 3 hours and 45 minutes, assisted by tailwinds as high as 170 m. p. h. Spectacular as the flight was, an even more remarkable aspect of it remained unpublicized for, before the flight took off, Lieutenant Dickson, Navy meteorologist, estimated the flight time to be 3 hours and 41 minutes! The takeoff time and route were deliberately planned to take advantage of the jet stream high in the upper troposphere. About 15 years ago, the possibility of such a flight would have belonged to the realm of fancy, yet today such feats of planning and flying are accepted as commonplace by the men who fly our modern jet aircraft.

Let us look for a moment at the phenomenon which made this flight possible—the jet stream. In a sense, the accumulation of knowledge leading up to this successful forecast began as early as 1933, when V. Bjerknes, J. Bjerknes, H. Salberg, and T. Bergeron first gave evidence for the existence of jet streams in their classic textbook, “Physikalische Hydrodynamik.” Eleven years later, in 1944, Professor Willett of the Massachusetts Institute of Technology published a paper showing a jet stream, but it was not until the closing phases of World War II in the Pacific that its practical importance became widely recognized. As the scene of operations in the Pacific Theater shifted northward in 1944 and 1945, United States high-altitude bombers began to report westerly winds of up to 250 knots

¹Reprinted by permission from The Roundel, Royal Canadian Air Force, Victoria Island, Ottawa, Canada.

over Japan. The air speeds at that time were such that a high-level bombing run from east to west under such conditions meant that an aircraft would present a stationary target for the antiaircraft batteries below. Here, then, was a meteorological phenomenon whose military significance could not be ignored.

The impact of this discovery on the meteorological world left little time for serious reflection on the nature of these strong, high-level air currents, which were later to be named "jet streams." Many questions remained unanswered. For instance, where are jet streams found? What is their structure? How do they behave? To answer these and other questions, the Office of Naval Research of the United States Navy sponsored a general atmospheric circulation project at the University of Chicago in 1946. Dr. C.-G. Rossby, one of the world's leading meteorologists, was called upon to direct the project. His colleagues were Palmén, Riehl, and many other outstanding meteorologists. Since then, research activities related to jet streams have spread to all parts of the world.

For a period of time, attention was focused on meteorological analyses of upper winds and temperatures obtained by radiosondes, which consist of meteorological instruments coupled with a small transmitter carried aloft by hydrogen- or helium-filled balloons. Winds were obtained by tracking the balloons with radar equipment. Out of these studies emerged a fairly complete large-scale picture of jet streams which has remained substantially unchanged in the light of subsequent research. In more recent years, research has been directed to the finer details of the wind field. A large part of jet-stream research is still being conducted by the United States Navy, Bureau of Aeronautics Project AROWA (Applied Research Operational Weather Analysis), at various locations in the United States and other regions of the world. Also actively engaged in this field is the Geophysics Research Directorate, Air Force Cambridge Research Center, which is sponsoring Project Jet Stream. The main task is to determine precisely the horizontal and vertical distribution of wind in jet streams in a large number of cases. For this purpose, specially instrumented aircraft are flown through jet streams, taking continuous observations whose analyses will yield details unobtainable in any other way.

STRUCTURE OF THE JET STREAM

As a result of the intensive preliminary studies at the University of Chicago and other institutions throughout the world, a relatively clear picture of the jet stream began to emerge. It was found that jet streams are worldwide features of the atmosphere. That is, they are essentially high-speed rivers of air that encircle the earth in the

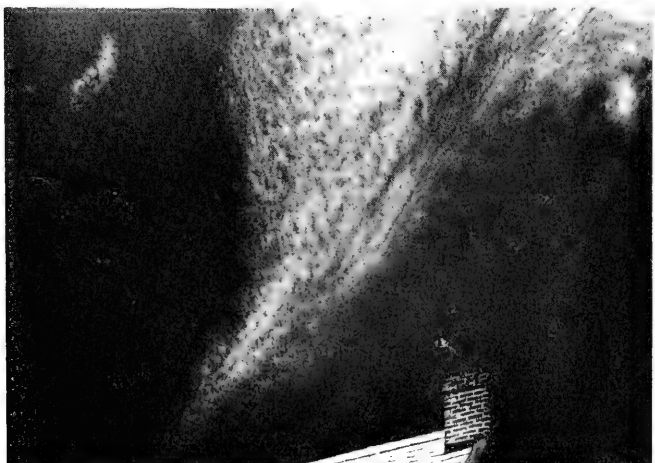

Typical jet-stream clouds as viewed from the ground. (Photographs courtesy of Dr. Vincent J. Schaefer, of the Munitalp Foundation, Inc.)

middle latitudes of each hemisphere. Air motion is generally from west to east; however, on any individual day, a jet stream may follow a meandering course that dips in some regions into the Tropics and extends north of the Arctic Circle in others. A schematic diagram showing a single jet stream is presented in figure 1. The heavy continuous line defines the axis of the jet stream along which the wind speed attains its maximum values in the horizontal. One can usually find the axis of a jet stream encircling the globe on any given occasion.

Figure 2 shows a view of a jet stream as seen by an observer looking downstream from a point along the axis. The numbers along the bottom of the diagram are the International Station Numbers which identify five stations in Alaska and one in the Yukon, lying approximately in a line oriented from northwest to southeast. From right to left, they are named, respectively, Kotzebu (133), McGrath (231), Fairbanks (261), Big Delta (263), Northway (291), and Whitehorse (964). The distance between Kotzebu and Whitehorse is 735 nautical miles. The ordinate is pressure in millibars (mb.) plotted on a logarithmic scale; 500 mb. corresponds very nearly to 18,000 feet, 200 mb. to 39,000 feet, and 100 mb. to 53,000 feet. Lines of equal wind speed in knots, called isotachs, are used to portray the wind field. Thus, within the central closed isotach around the main jet axis, labeled J, above 400 mb., the wind speed is in excess of 90 knots.

If we consider the horizontal width of that band of winds in excess of a given value, say 80 knots, we would find it to be surprisingly narrow—of the order of 100 miles in this example, but generally about 300 nautical miles. The vertical depth of the winds greater than 80 knots in figure 2 is less than 2 miles. A comparison of the horizontal width of this jet core with the depth would lead us to the conclusion that the jet stream can be represented fairly accurately in shape by a flat ribbon parallel to the earth's surface. Other features on the cross section are the tropopause, indicated by the discontinuous heavy line around the 300–400-mb. levels, and the continental arctic frontal surface separating the relatively warm maritime arctic air mass on the right of the diagram from the cold continental arctic air to its left. The broken lines are isotherms labeled in degrees Centigrade.

RELATIONSHIP BETWEEN JET STREAMS AND FRONTS

This particular cross section is typical of the northernmost jet stream which has been encountered by R. C. A. F. flights many times in the past. Further studies of jet streams have revealed that, on the average, four main tropospheric jet streams are present over North America during the winter months. Except for the southernmost subtropical jet stream which usually appears in the vicinity of Florida and Cuba, each of the other three is closely associated with one of

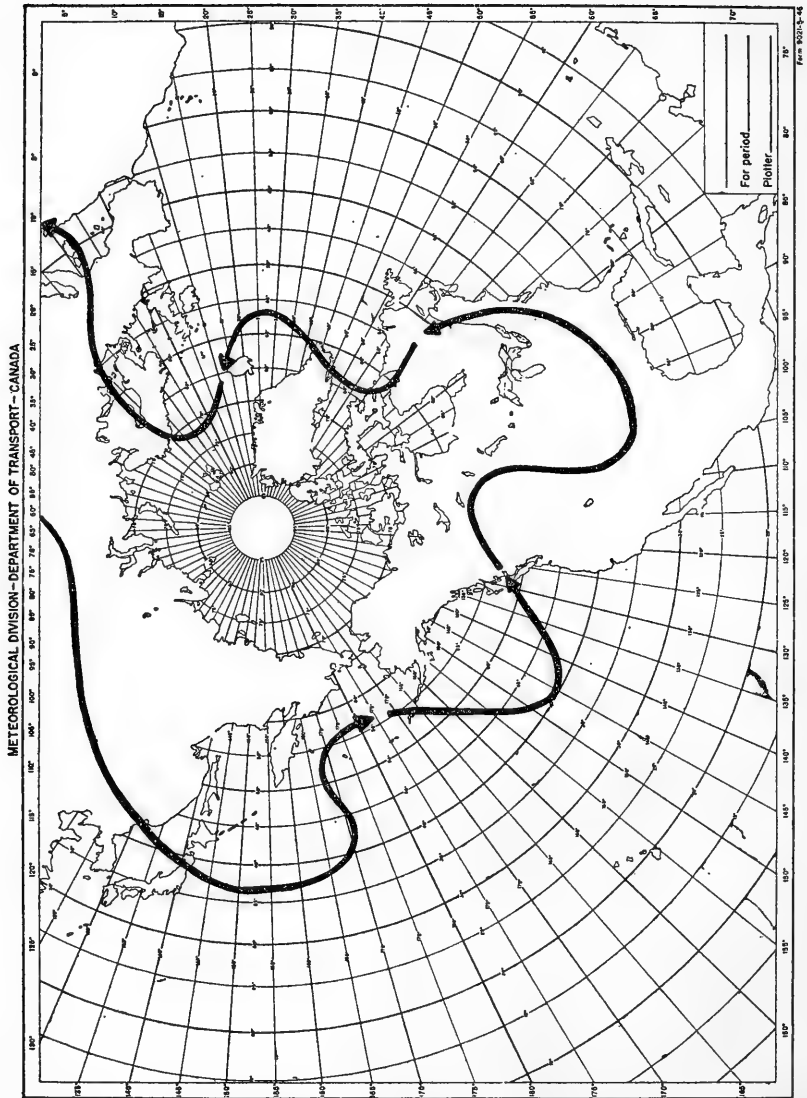

FIGURE 1.—Typical path of the polar jet stream in the Northern Hemisphere.

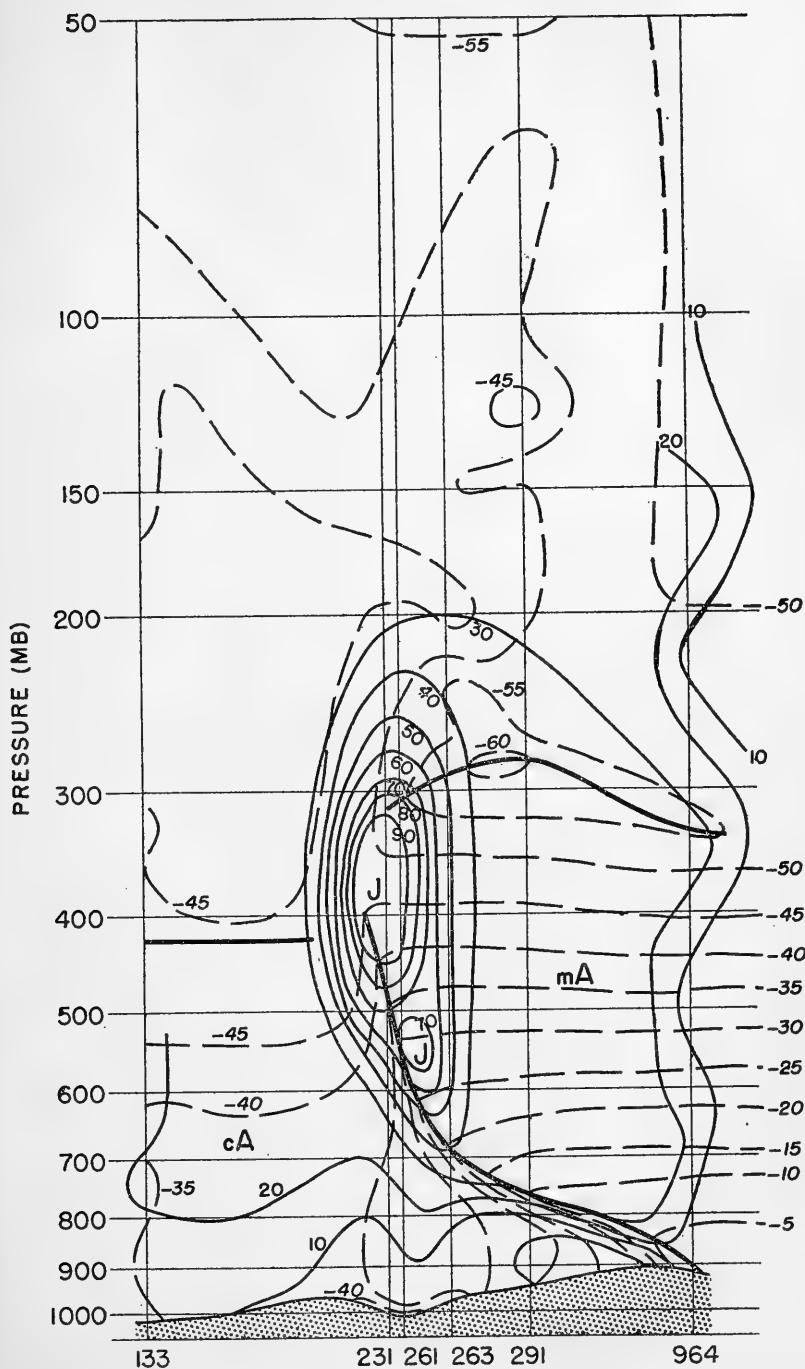

FIGURE 2.—View of continental-arctic jet stream seen looking downwind (after McIntyre and Lee, 1954). Lower numbers identify Alaskan and Yukon stations. Ordinate is pressure in mb. Solid lines are isotachs in knots. Broken lines are isotherms in °C. Heavy solid lines show frontal surface and tropopause.

the three main frontal surfaces over North America in winter. These three frontal surfaces are respectively called the polar front, the maritime arctic front, and the continental arctic front, found in this order from south to north. The polar and maritime arctic jet streams have structures very similar to the continental arctic jet stream in figure 2. There is one fundamental difference between them, namely, the height of maximum wind speed is found at higher altitudes as one proceeds southward. For instance, the axis of the continental arctic jet stream is normally found between 25 and 30 thousand feet, the maritime arctic jet stream between 32 and 36 thousand feet, and the polar front jet stream between 35 and 40 thousand feet. These jet streams are also found over Japan in winter. Thus we can see why the strong winds were not encountered by the high-altitude bombers of the Second World War until the scene of operations moved sufficiently far north in the western Pacific.

Another notable fact about the three northernmost jet streams is that the axis of each jet stream is always found in the warm air above its respective frontal surface and most often above the 500-mb. (18,000 feet, very nearly) position of the front. This relationship has immediate value to the meteorologist, for, by means of it, he is able to estimate the location of a high-level jet stream from temperature data at the relatively low level of 500 mb., even in the absence of high-level wind observations. Furthermore, knowing which front he is dealing with, he can provide a reasonable estimate of the height of the axis. One other feature brought out by extensive cross-section studies is that the strongest winds at any level below the axis are invariably found in the warmer air.

JET STREAM WINDS

The wind speeds in the jet-stream cross section shown in figure 2 are not particularly high compared with those found at lower latitudes. Both the maritime arctic and polar jet streams consistently exhibit stronger winds on any given occasion. In fact, the strongest winds are found where two or more jet streams move closely to one another. Although this can occur anywhere, the preferred locations for such intense jet streams are the eastern coastlines of the Asian and North American Continents.

What are the highest wind speeds likely to be found in jet streams? In the past, wind-speed measurements as high as 400 knots have frequently been reported in weather messages. However, when the original observations, which are obtained by balloon-tracking methods, are carefully checked, they are invariably found to be in error. For example, a reported 400-knot wind over Philadelphia late in January 1955 was checked and found to be incorrect on account of instrumental

difficulties. The revised estimate of the maximum wind was around 270 knots. Recently a number of accurate wind measurements have been made by aircraft flying across selected jet streams. The highest reliable measurement made by this method up to November 1955 is 290 knots. However, it must be stressed that this figure does not necessarily belie the accuracy of winds reported by other aircraft not similarly equipped. A case in point is the encounter by a *Comet* of a 350-knot wind over Tokyo.

Another significant feature of jet streams is brought out by the vertical cross section in figure 2—the asymmetry of the wind distribution about the axis. The speeds decrease more slowly with distance on the right side of the axis than on the left side, facing downstream. Thus, a pilot wishing to maintain strong tailwinds would find it advantageous to stay to the right of the jet-stream axis, where a slight shift in location relative to it will produce little change in the tailwind component. A corresponding shift on the left side of the axis will result in a considerably larger decrease in the tailwind. Now, on the right side of the jet stream, the wind can drop off at a rate as high as 35 knots per hundred nautical miles. On the left side, however, there can be a much greater rate of decrease in wind speed with distance; actual measurements have shown rates as high as 100 knots per hundred nautical miles.

It is also important to know the wind-speed variations in the vertical, or vertical wind shear. Above and below the jet axis, the wind speed decreases at an average rate of 10 to 15 knots per 1,000 feet. Extreme values of the vertical wind shear have been found to be as high as 30 to 35 knots per 1,000 feet by B-47 flights. Generally speaking, it is only necessary to fly at right angles to the wind for a short distance at the same height, simultaneously taking frequent observations of air temperature, to find whether one is above or below the axis. If the temperature changes very little, one will know the flight level is near the level of maximum wind speed. If the temperature increases while flying to the left of the wind, one can conclude that the flight level is above the level of maximum wind. Finally, if the temperature decreases while flying to the left, the flight level will be below the level of maximum wind. This association of the vertical wind shear with the horizontal temperature field is known to meteorologists as the "thermal-wind relationship." It has been exploited by many commercial airline pilots to locate high winds on long flights across the Atlantic and Pacific Oceans. By way of example, Capt. Bernard C. Frost of B. O. A. C., in flying the North Atlantic routes between 15,000 and 25,000 feet, found that the outside air thermometer was a very valuable guide to the location of jet-stream winds. Once in a strong wind at a certain altitude, he found that the

strong wind could be maintained by flying along the same isotherm. He further states:

An amazingly accurate guide for calculation of wind strength on either side of the jet stream (within altitude limits normally flown; viz, 15,000-25,000 ft.) was that the wind decreased some 8 knots for every degree Centigrade drop in temperature on the polar (or cold) side; and it decreased some 16 knots for every degree Centigrade rise on the equatorial (or warm) side.

N. E. Davis, writing in the September 1954 issue of the *Meteorological Magazine*, described a successful trans-Atlantic crossing in a jet stream by a B. O. A. C. *Stratocruiser*, under Capt. L. V. Messenger and Navigating Officer M. H. Sutcliff, on August 2-3, 1953. By the judicious use of their outside air thermometer, they were able to locate and fly for three hours (about 1,000 miles) in the strong winds below a jet stream. The penetration of the jet stream from the cold side was indicated by a sudden rise in air temperature.

Therefore, to maintain strong tailwinds when flying below the jet axis, one should endeavor to stay in the warm air. Above the jet stream, one should try to stay in the colder air to the right of the jet axis. In a similar manner, the temperature field can be used to detect and maintain a track along which the headwinds will be more favorable, if one is flying into the wind.

Research flights across jet streams have revealed some interesting details of the wind field in the vicinity of their axes. The results of several such flights under project AROWA have recently been published. They have shown that the wind speed is rather variable within a jet-stream core. Winds have also been found to vary considerably with time at a fixed point. For instance, Lt. Col. R. C. Bundgaard, U. S. A. F., reported that the wind speed changed from 120 knots to 60 knots, and again to 120 knots, within 4 hours at 34,000 feet over Dayton, Ohio, on March 5, 1954. On another occasion, five B-47's observed a wind change from 200 to 72 knots at 40,000 feet over Alabama during a 3-hour period on April 14, 1953. Such variations are impossible to forecast at the present state of knowledge. It is hoped that further research into the mechanics of air motion will provide answers in the future.

CLOUD FORMS OF THE JET STREAM

Through the work of Dr. Vincent J. Schaefer, of the Munitalp Foundation, Inc., and many military as well as commercial pilots, there has now been gathered considerable information on cloud forms associated with jet streams. This knowledge can be used as an auxiliary tool to locate jet streams.

Dr. Schaefer has found four main cloud types associated with jet streams. They are cirrus, cirrocumulus, lenticular altocumulus, and

altocumulus, extending from horizon to horizon, and having waves at right angles to the air flow. From the ground, these clouds can be observed to move at great speeds, often resulting in rapid local changes in cloud cover during short intervals of time. Plate 1 shows three of Dr. Schaefer's remarkable photographs of typical jet-stream clouds as observed from the ground.²

Aloft, cloud formations at various levels can often give indications of the wind direction. Under conditions of high winds, an upper cloud surface will show streaks in the direction of the wind and a billow structure at right angles to these streaks, in a manner analogous to wind lanes on a sea surface with a superimposed transverse wave pattern.

CLEAR-AIR TURBULENCE

It was once thought that aviation hazards, such as icing and turbulence, were confined to the lower troposphere, and that, once aircraft could fly "above the weather," all problems of flight comfort would be solved. This myth exploded when high-altitude aircraft encountered turbulence as violent as that encountered at low levels. The bumpiness, or turbulence, is described by those who have experienced it to be like the pounding of a fast speedboat racing across a very choppy sea surface. Since there is no visual warning, it has been called clear-air turbulence.

In order to ascertain the nature of this phenomenon, many special research flights have been carried out over the British Isles, Europe, and the United States. Through the kind cooperation of R. C. A. F. personnel, the Meteorological Service of Canada has also acquired and studied numerous turbulence reports. The conclusions reached by various investigators are largely in agreement, but there are also contradictions which will only be resolved by further research.

Clear-air turbulence can occur at any level of the atmosphere flown thus far. It is generally found in isolated patches 50 to 100 miles in length and width. These patches consist of one or more layers, the vertical thicknesses of which are generally not great, being of the order of 500 to 3,000 feet. On occasion, thicknesses of 6,000 feet or more have been reported. Because clear-air turbulence occurs in layers, a satisfactory method of moving out of turbulent air is to change altitude by 1,500 to 2,000 feet.

Clear-air turbulence has been found to occur in the vicinity of jet streams where the wind speed varies greatly with distance in the horizontal or vertical. Thus, the regions above, below, and to the left of the jet axis, facing downstream, are the preferred locations of tur-

² The writer wishes to express his gratitude to Dr. Schaefer for permission to publish these photographs here.

bulence. The air in the core of the jet stream and to its right is smooth by comparison. If an aircraft is flying parallel to a jet stream, an attempt should be made to fly on the right side of the jet axis, because not only would there be a smaller chance of encountering turbulence, but also there would be the added advantage of maintaining strong tailwinds.

The frequency of various intensities of turbulence has been studied by J. Clodman, of the Meteorological Division. Analysis of more than 500 reports of aircraft turbulence over a height range of 18,000 to 45,000 feet revealed the following results. For three stations where reports of nonoccurrences were also made, about a quarter of all flights encountered turbulence. Fifty-two percent of these occurrences were classed as light, 25 percent as moderate, 5 percent as heavy, and 3 percent as severe. The remainder were classified as light to moderate or moderate to heavy. Hence the majority of these occurrences were in the light or moderate range. The few cases of moderate and heavy turbulence occurred in layers not greater than 3,500 feet in depth, in agreement with the results obtained in Britain.

A comparison of the frequency of turbulence reports at each level with the frequency of time flown at each level showed that they were almost identical, from which it is inferred that the probability of encountering turbulence at any level from 18,000 to 45,000 feet is approximately the same.

A study of turbulence reports collected on *Canberra* test flights over Britain was described by Eric Hyde, test pilot of Short Bros. and Harland Ltd., of Belfast, in the April 1954 issue of "Flight." The general conclusions are similar to those reached elsewhere. However, they do report that the intensity of turbulence decreased with increasing height. For example, all cases of severe and violent turbulence were encountered below 30,000 feet, the area most affected being around 25,000 to 29,000 feet. The highest recorded altitude of turbulence was 49,000 feet, where only light turbulence was felt. Only rarely was turbulence encountered above the tropopause, and it was never greater than moderate. In contrast to experience elsewhere, there were many flights through well-documented jet streams which yielded no trace of turbulence at all.

Pollen and Spores and Their Use in Geology¹

By ESTELLA B. LEOPOLD and RICHARD A. SCOTT

United States Geological Survey, Denver, Colo.

INTRODUCTION

THE WIDESPREAD aerial distribution of plant spores and pollen is made obvious each year by the symptoms of the many hay fever sufferers—the pollen count has become as familiar a daily statistic as the relative humidity. Less obvious is the fact that the circulating spores and pollen inevitably must settle out of the air, thus becoming a part of the continuing accumulation of sediments at the earth's surface. This incorporation of the rain of pollen and/or spores apparently has gone on throughout geologic time since the evolution of spore-bearing plants, although appreciation and utilization of this fact are relatively recent developments in paleontology.

In the past 25 years there has been increasing use of these plant microfossils in solving scientific problems ranging from the reconstruction of the forest environment of prehistoric man to the correlation of Paleozoic coal seams. They are especially valuable in determining the changes in climate associated with advances and retreats of the Pleistocene ice. The study of pollen and spores, formally called *palynology*, is yielding information increasingly useful in dating sequences of sedimentary rocks and in interpreting past environmental conditions and climatic successions.

Pollen grains are small (5–200 microns in diameter) reproductive structures representing the male gametophyte in the seed plants. Their transfer to the female reproductive apparatus, a necessary preliminary to fertilization, is effected primarily by wind, water, or by insects. Pollination by wind is necessarily an inefficient process involving a vast supply of pollen grains; some wind-pollinated plants have as many as 10,000 grains per stamen in flowers with many stamens, and more than 10 million grains may be produced by a

¹ Publication authorized by the Director, U. S. Geological Survey.

single catkin (e. g., birch; Erdtman, 1954). Only minute proportions of this quantity of pollen grains complete their role in the reproductive cycle of the plant, the excess being the primary source of the pollen rain incorporated into the sedimentary record. Most plants adapted to pollination by insects produce fewer pollen grains per flower, although some insect-pollinated plants produce enough pollen to be represented regularly in the pollen rain.

Spores, produced by so-called lower plants ranging from the fungi through the ferns, lycopsids (club mosses), and sphenopsids (horsetails), may represent different aspects of the life cycle in different groups but have in common their function as a means of dispersal. Some species among the ferns, lycopsids, and sphenopsids are heterosporous, producing two kinds of spores differing in function, structure, and usually in size. The female or megaspores are typically large, ranging from about 150 to several hundred microns in maximum dimension; the male or microspores are usually smaller, from about 25 to 100 microns in their maximum dimension, and are produced in far greater numbers than megaspores. However, sex, not size, is the fundamental difference between megaspores and microspores.

Megaspores are usually less abundant and less widely disseminated than microspores. Although they have been described from younger beds (Dijkstra, 1951), megaspores are most important as microfossils in the Paleozoic. They were produced in numbers by arborescent lycopsid and sphenopsid plants that were important components in the vegetation forming the Carboniferous coals.

The persistence of pollen and spores in numbers in sedimentary rocks of diverse geological ages is due to the remarkable resistance of their walls to most degradative processes. The walls of pollen grains and spores are composed of a waxlike compound, a chemically undefined polymer of stable, long-chain molecules. This compound, one of the most enduring organic substances found in nature, is resistant to acidic or basic solutions. It is, however, susceptible to oxidation resulting from prolonged exposure to air; consequently, pollen and spores are best preserved when deposited in relatively anaerobic environments.

The wall of a modern pollen grain is complex structurally, usually consisting of an outer, 2-layered *exine* and an inner *intine*. Post-mortem changes result in the degradation of both the contents of the pollen grain and its intine, so that only the exine remains in fossil material. Modern pollen grains can be treated chemically to leave only the exine for comparison with fossil pollen.

A great diversity of shapes and morphological features is found among the pollen and spores produced by the many kinds of plants.

Although the grains of certain unrelated plants are similar enough to be virtually indistinguishable, this situation is not common enough to be a major problem. Pollen grains of the flowering plants are in general radially or bilaterally symmetrical, although a few asymmetrical forms are known. Many pollen grains are basically spheroidal, but modification into various other geometric shapes is common, and flattening as a result of compression is usual in fossil material. The appearance of a single pollen grain may vary depending upon whether it is seen in polar or in equatorial view. The appearance of many pollen grains reflects the presence of pores and/or furrows (*colpi*), which may function as exits for the pollen tube at germination of the grain. Various combinations of these apertures occur; three to many furrows and/or pores are common in pollen of dicotyledonous plants, and one-furrowed grains occur frequently in monocotyledonous and gymnospermous plants. Pollen grains of other gymnospermous (coniferous) plants have elaborate bladders or wings. Some basic structural features of typical pollen grains are illustrated in figure 1.

Spores of mosses and ferns commonly bear a triradiate tetrad scar, representing the lines of contact of the four spores produced as a result of the two successive divisions of the spore mother cell. Most pollen grains are also produced in tetrads, but with the exception of a few extinct gymnosperms, do not retain the triradiate scar. Spores with a single scar (*monolete*) and without a scar (*alete*) also occur. Some examples of the basic shapes of modern spores are shown at the top of figure 1.

The tremendous variety in wall texture, shape, and configuration provides a reliable basis for the categorization of many isolated spores and pollen grains, either in terms of their natural affinities or into morphological types. Both approaches are utilized by palynologists. Natural affinities must be determined for the interpretation of paleoecological and floristic information, though stratigraphic correlations can be carried out by the matching of morphological types with little regard for their relationships to the parent plants.

DISPERSAL OF POLLEN AND SPORES

Basic to interpretation of a fossil pollen assemblage is an understanding of the factors affecting the original representation of spores and pollen at the locality. This representation is determined by a complex of factors, including the proportion of wind- and insect-pollinated plants in the contributing vegetation, the total pollen production of individual plants and their relative abundance in the contributing vegetation, and the meteorological and other conditions affecting distance of transport.

Spores of ferns and mosses are disseminated by wind or water, but pollen is distributed either by the wind, water, insects, or oc-

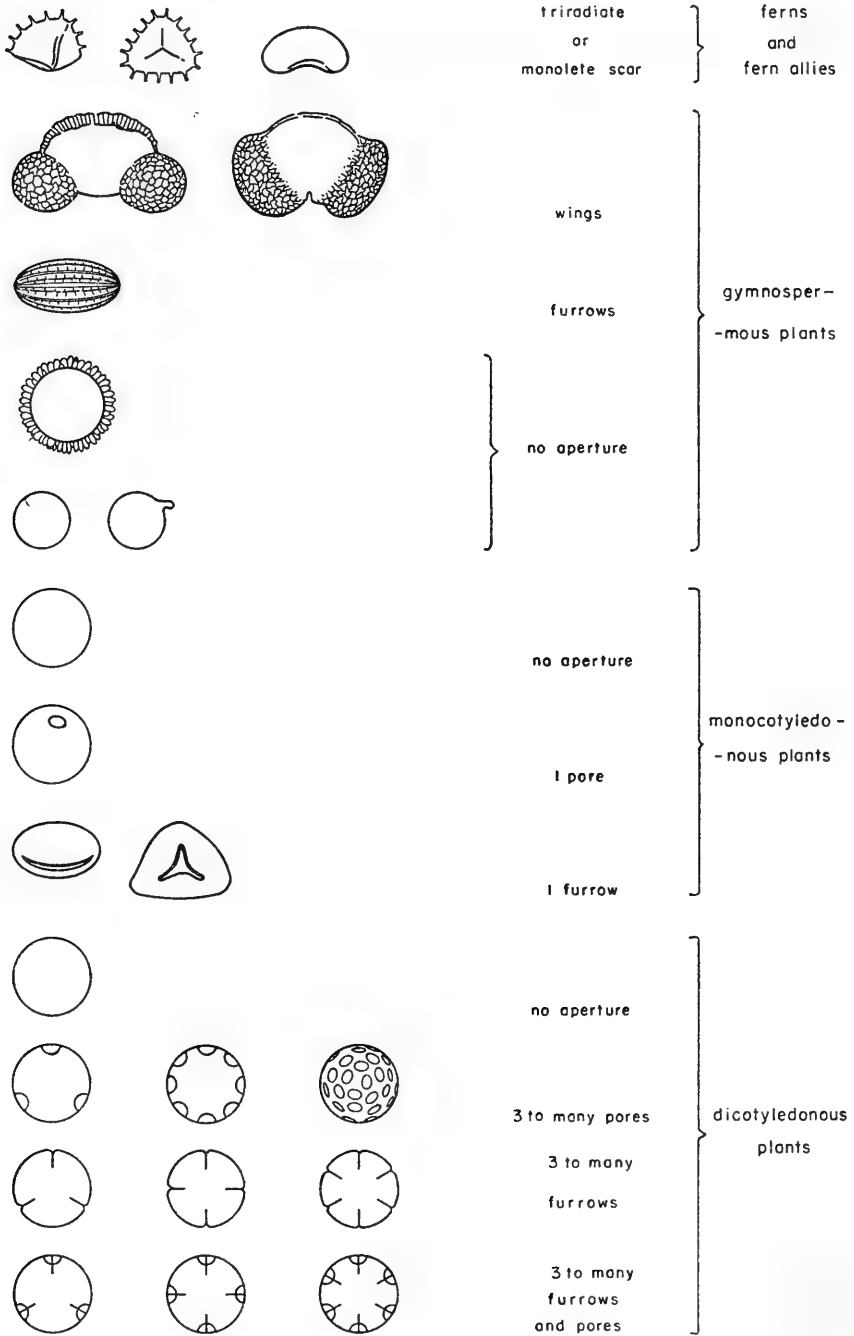

FIGURE 1.—Some common pollen and spore forms.

asionally by birds or other agents. The mechanisms of dispersal have been important in the evolution of the number and type of pollen grains produced by each plant species. Because wind is a random agent in comparison with insects, whose travels about the plant usually are motivated, production of enormous numbers of pollen grains has definite survival value among wind-pollinated plants. In addition to being produced in greater numbers per flower, pollen

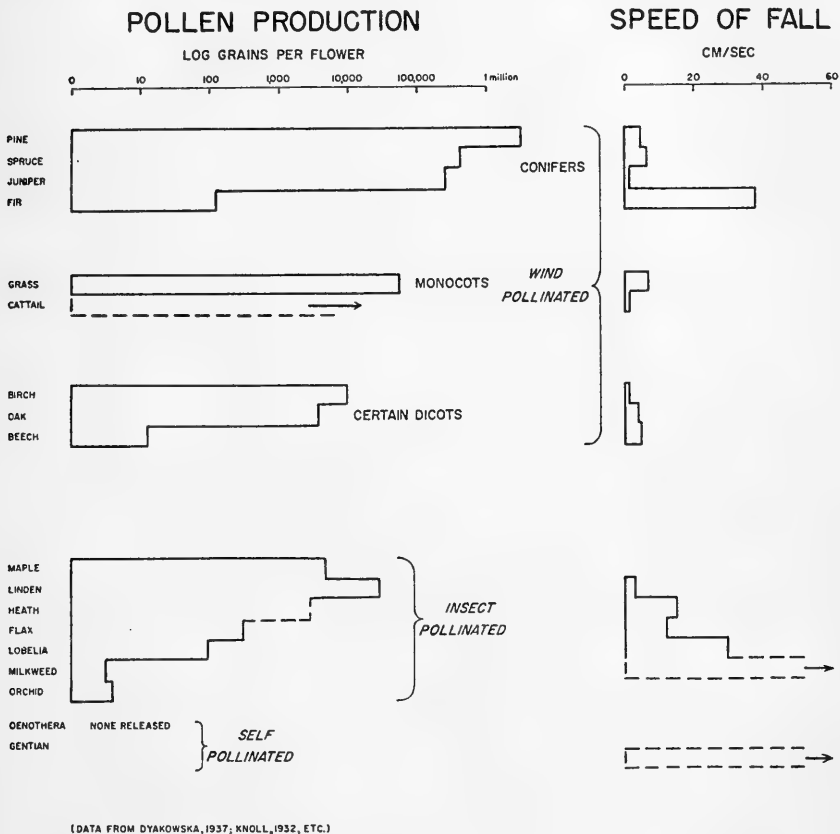

FIGURE 2.—The approximate numbers of pollen grains produced per flower, and the buoyancy of single grains (measured by rate of fall in air) for some common plants.

adapted for wind dispersal is usually lighter and less sticky than that adapted for transport by insects. A quantitative comparison of pollen production for some common wind- and insect-pollinated plants, and specific gravity of grains as measured by rates of fall in air, is shown in figure 2. Some insect-pollinated plants do produce a large amount of pollen (e. g., willow), and some pollen adapted for transport by insects is carried by air currents and deposited in environments favorable for its preservation. Nevertheless, the differ-

ences in number and buoyancy usually result in an exaggerated representation of the wind-pollinated types in the pollen rain in relation to the numerical importance of the parent plants in the source vegetation. Conversely, insect- and bird-pollinated species, which are particularly important in the arboreal vegetation of tropical regions, may not be well represented in the sedimentary record.

The distances to which pollen grains may travel vary widely with the nature of the grains, location of the source plants, and weather conditions. For example, light grains tend to travel farther than heavier ones, and pollen produced by plants forming the forest canopy is more favorably situated for long-distance dispersal than pollen originating in the undercover. Anthers typically open during dry, sunny weather when thermal updrafts may be present to raise the pollen to altitudes favoring extended transport. Mixing of pollen grains in the air produces a more or less representative sample of the regional vegetation. The fall of pollen from the air is hastened by such factors as rain, increase in the relative humidity, and decrease in wind velocity. By far the major amount of pollen is deposited in the immediate area of the producing plants, and most pollen is removed from the air within a distance of 50 to 100 kilometers (Faegri and Iversen, 1950). Long-distance transport of single grains for distances of as much as 1,000 kilometers is on record (Erdtman, 1954), but these rare occurrences do not appreciably affect the reliability of a mass sample of pollen. In general, however, the occurrence of fossil pollen is a less reliable indication that a particular plant grew in the immediate vicinity than is the presence of leaves or other detached parts.

Within the temperate zone it has been shown that the density of pollen in the air is greatest over the continents and falls off rapidly as one travels out to sea. Erdtman (1954) cites an example in which the pollen content of the air over the coastal plain of eastern Sweden was several thousand times greater than the amount present in the air 200 miles west of the European coast at the same latitude. The density of pollen in the air in an inland mountainous area in Norway has been investigated by Faegri (Faegri and Iversen, 1950), who reports that the tree pollen fallout at collecting stations in the montane forest belt was 13 times greater than the fallout received by stations at and above timberline (fig. 3).

Factors affecting the relationship of the pollen rain to the source vegetation have been listed by Kuyl et al. (1955). These authors point out in part that pollen may be retransported after its original deposition but before it is incorporated into sediments. This secondary transport may be by wind, or if the pollen falls into running water, it may be carried long distances in the stream before final

deposition. Transportation by rivers, as well as by wind, may be responsible for the intermingling of pollen derived from entirely distinct ecological assemblages.

The interplay of these factors has been illustrated by a study of the modern pollen fallout at Eagle Lake in northern Maine (Hyland et al., 1953). The aerial pollen fallout in 1950 was measured by counting the numbers of different pollen and spore types falling on a "sticky slide" exposed for daily intervals during the growing season (fig. 4).

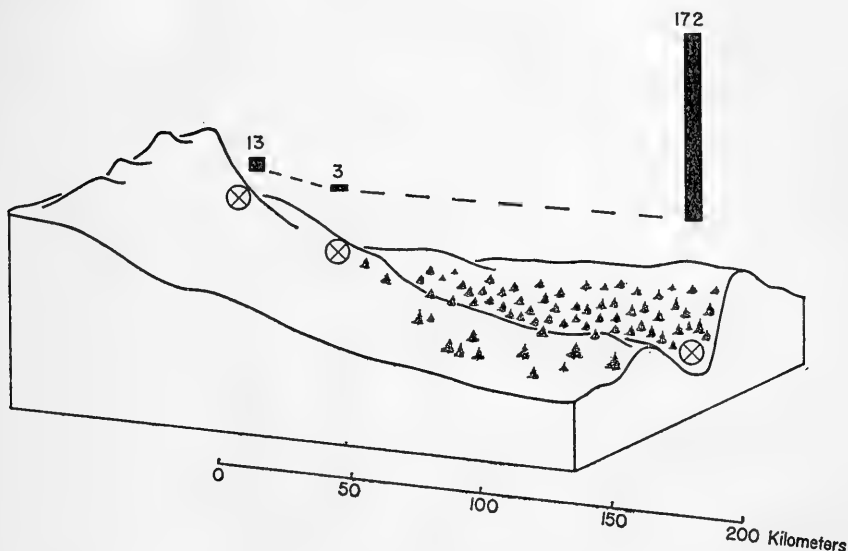

FIGURE 3.—Pine pollen fallout (number of grains per square centimeter) at mountain stations in Norway during the growing season of 1942. Stations within the forest area accumulate much more pollen than those near timberline. (From Faegri and Iversen, 1950.)

The results show first that pollen rain is actually a series of fall-outs that occur during the blooming periods of different local plant types; the trees release pollen in the spring, and grass pollen, weed pollen, and fungal spores appear during middle and late summer. Coniferous trees numerous in the local forests (pine, spruce, and cedar) contribute heavily to the total yearly average, but oak and elm, rare types in the local stands, are poorly represented in the pollen rain at this site.

All the spore and pollen types shown in figure 4 are wind transported except maple and willow, which grow in profusion on nearby ridges. These are rather meagerly represented in the yearly average pollen rain in comparison with their density in the vegetation at the immediate site. Insect-pollinated plants including maple and willow

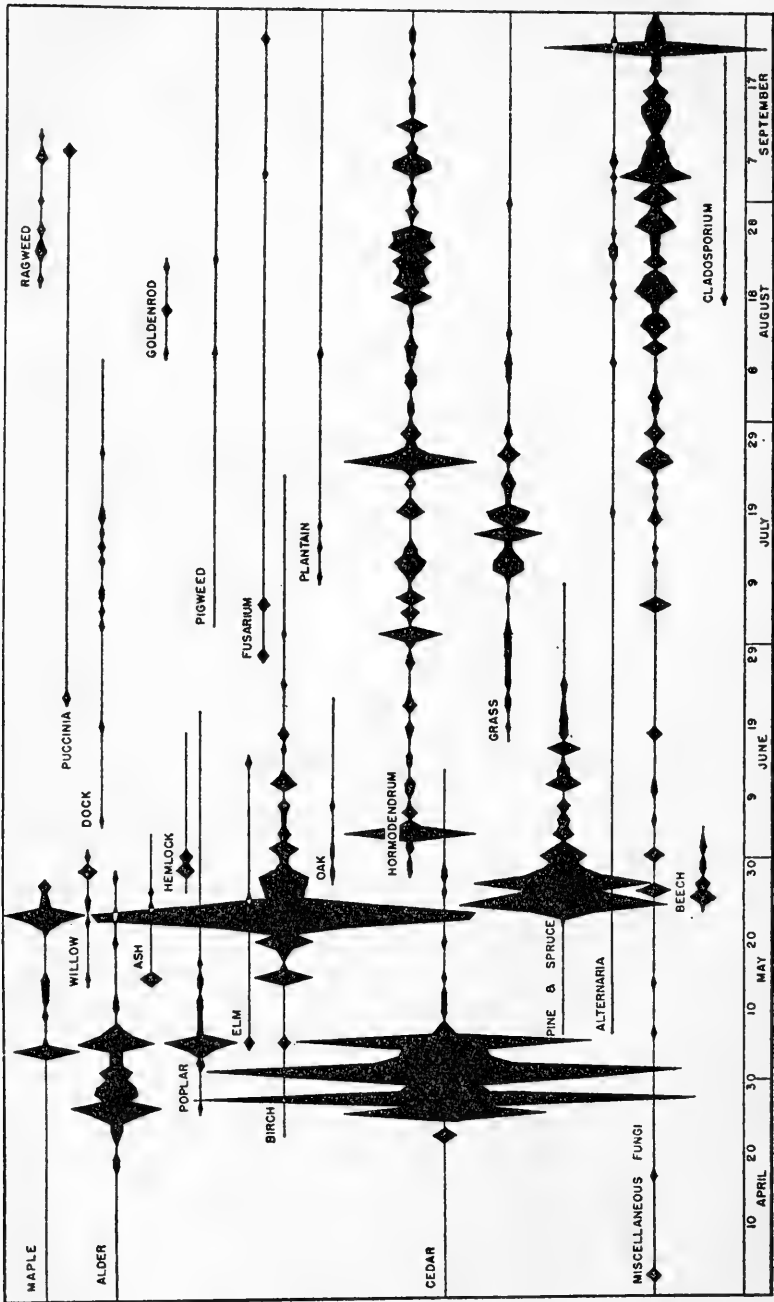

FIGURE 4.—The pollen rain at Eagle Lake, Maine, during the growing season of 1950. Data were obtained by exposing sticky microscope slides, which were changed daily. (Graph from Hyland et al., 1953.)

and those in the unknown category (not shown) represent a total of only 10 percent of the 1950 pollen rain.

From studies of this type it can be seen that the pollen rain of an area reflects the local vegetation only in a general way, and that the representation of wind-pollinated species is better than that of insect-pollinated species. The amount of total pollen rain may vary from year to year depending on fluctuations in weather affecting blooming and pollen dispersal, but during a 10-year period the percent composition of the total sample remains somewhat similar for a given station.

FACTORS IN DEPOSITION

Although the aerial pollen rain settles out at random as a fine dust on land and water, pollen does not persist in numbers at or near the soil surface owing to prolonged exposure to oxygen and to alternate wet and dry conditions. Water-laid sediments that remain wet for long periods of time and that are relatively deficient in oxygen provide the conditions under which pollen is best preserved. Many lakes and quiet lagoons have a low dissolved-oxygen content in their deep-water layers and particularly at and below the mud-water interface (Vallentyne, 1957); consequently, these environments, along with acid peat bogs, furnish extensive areas for the accumulation of pollen.

Because the pollen rain is progressively less in the seaward direction, sedimentary environments in which pollen concentrations can be found are limited to near-shore sites in marine and lacustrine waters. Pollen and spores from modern marine sediments are often associated with microalgae, diatoms, and other forms of oceanic plankton; conversely, assemblages from fresh-water sediments often include typically fresh-water microorganisms. Evidence of this sort provides the paleontologist with a way to recognize the environment of deposition of a fossil sample.

Pollen and spores are of silt size and are readily eroded with the sediment in which they are imbedded. Modern fluvial erosion of Tertiary pollen-bearing rocks, followed by transport and deposition of the Tertiary pollen in a modern stream terrace, is not uncommon. The situation can be recognized from the resulting mixture of extinct or ecologically displaced pollen types with a modern assemblage.

Redeposition of pollen has been observed in sediments originating during periods of rapid erosion by glacial meltwater streams draining ice masses that eroded older, pollen-bearing beds (Iversen, 1936). Redeposited pollen does not seem to be important in most highly organic sediments such as peats, coals, and black muds, but the palynologist must be constantly on the alert for it.

The quantity of pollen and spores in a sediment sample is determined by the relationship between the density of the pollen rain and the rate of accumulation of the sediment. Maximum concentrations of pollen are produced by dense pollen rains in combination with slow deposition of sediment. Original low density of pollen in a deposit can result from either a light pollen rain or from dilution of a heavy pollen rain by rapidly accumulating sediments. Examples of these relations are shown diagrammatically in figure 5. Bars in the lower part of the figure show the probable rate of annual sediment accumulation; those in the upper part form a record on a logarithmic scale of the number of pollen grains per gram (dry weight) of sediment.

Rich in pollen are samples of lake peat and lake clay from Durham, Conn. (on right, fig. 5). It has been determined by carbon-14 dating that these sediments were deposited very slowly, perhaps at the rate of only one millimeter per year. The rich pollen flora contained in these sediments indicates that at the time of deposition well-developed coniferous forests grew near the lake. In all probability the annual pollen rain was like that of coniferous forests now growing in central New England, perhaps 70,000 grains per square centimeter per year.

A sample of varved (laminated) glacial clay from Hartford, Conn., poor in pollen (fig. 4), is laminated in a manner that indicates rapid sedimentation. The varves, which are 10 millimeters apart, mark increments of sediment that accumulated annually or oftener. Although the pollen rain may have been less than the present fallout at that site, the low pollen content in this sediment seems to have been due primarily to dilution of the pollen by rapid sedimentation.

The most sterile sediment among these examples is a modern lagoonal mud from Kapingamarangi Atoll in the South Pacific. This sample, along with 10 others from different depths, contains 25 or fewer pollen grains per gram of sediment (McKee et al., MS.). The total land area of the atoll islands that surround this lagoon is less than one square mile, and does not support sufficient vegetation to furnish large quantities of pollen locally. In spite of the slow rate of sediment accumulation at these sampling stations (McKee et al., MS.), the pollen density remains low owing to the limited numbers of source plants.

POLLEN- AND SPORE-BEARING ROCKS AND THEIR LABORATORY TREATMENT

Unweathered sediments originating in reducing environments are most apt to contain pollen; these include marine and fresh-water shales, limestones, siltstones, coals, peats, and lignites. High organic content, usually manifested by dark color, is often an indication of

the presence of pollen and spores. Sandstones are usually barren, but the absence of pollen from many coarse, aquatic sediments is thought to be a derived condition. Modern lake sands that have been continuously wet since deposition often contain an abundance of well-preserved pollen and spores, but lacustrine sandstones that have been elevated and partially eroded usually contain none. Sediments having

POLLEN DENSITY

LOG GRAINS PER GRAM DRY SEDIMENT

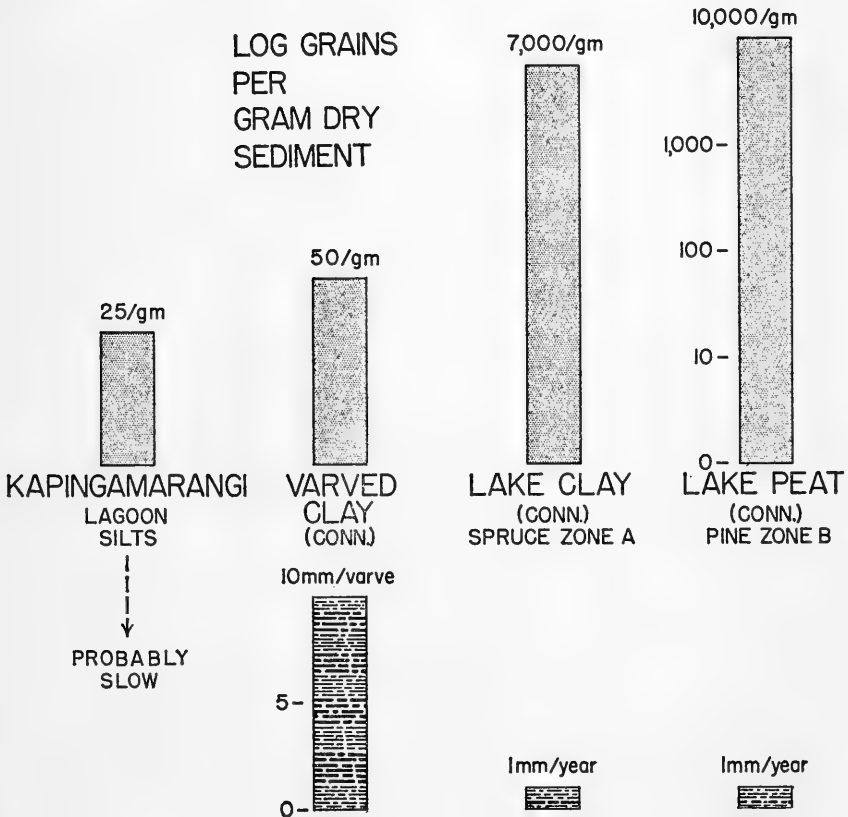

RATE OF SEDIMENT ACCUMULATION

FIGURE 5.—Pollen density in sediments compared with the rate of sediment accumulation. Kapingamarangi lagoon sediments (left) are low in pollen, owing to poorly developed local vegetation; the varved clay (second from left) is low in pollen because of dilution of pollen rain by rapid sedimentation; the sediments in the two remaining examples (right) are rich in pollen because of dense contributing vegetation combined with a slow sedimentation rate.

a grain size coarser than that of fine sand facilitate the penetration of oxygen and percolation of ground water to an extent destructive to spores and pollen.

Sedimentary rocks altered by the heat and pressure of metamorphism or by extensive weathering and exposure are usually sterile, although they may once have contained pollen. Original sterility may be the case in deep-water deposits which were laid down too far from land to receive an appreciable pollen rain.

The preparation of fossil pollen requires the facilities of a chemical laboratory equipped with a fume hood, centrifuge, miscellaneous glassware, and a microscope providing magnifications between 100 and 1,200. Care must be taken to prevent the introduction into the sample of stray pollen from dirty glassware or the air.

Pollen and spores imbedded in a sediment must be separated from the mineral matrix in order to observe them. Detailed explanations of the treatments used are given by Faegri and Iversen (1950). Two common procedures employed to accomplish the separation entail either dissolving the mineral fraction by reagents that will not destroy pollen, or differential flotation of the sediment using heavy liquids in which the organic residues float while the mineral fraction sinks. Common reagents for the first procedure are HCl for dissolution of carbonates, followed by HF to eliminate silicates. The second (flotation) technique may be accomplished, after physical maceration of the rock, by the use of a bromoform-acetone mixture adjusted to a specific gravity of 2.3 (Frey, 1954). Coals may be broken down by oxidation with Schulze's solution. The high concentration of dark humic substances in coal, lignite, and peat often requires the use of decolorizing agents, bleaches or strong bases, to clarify the otherwise opaque organic material. Acetylation is often used to remove cellulose. Variations of these procedures have been developed in each pollen laboratory to deal with the matrix at hand.

After the pollen is isolated from the sedimentary matrix, it is washed free of the reagents used in preparation and mounted on slides in glycerine jelly, balsam, or a synthetic mounting medium.

INTERPRETATION OF THE FOSSIL SAMPLE

Because of the similarity of Pleistocene plants to modern ones, identification of their pollen with modern genera or (in part) species is theoretically possible for such relatively young material. Much pollen of Tertiary age can safely be attributed to living genera too, but in Cretaceous assemblages the detection of modern genera is usually difficult and often questionable because of the great amount of evolution and extinction that has since occurred. Older fossil material, e. g., pre-Cretaceous spores and conifer pollen, is usually placed in extinct

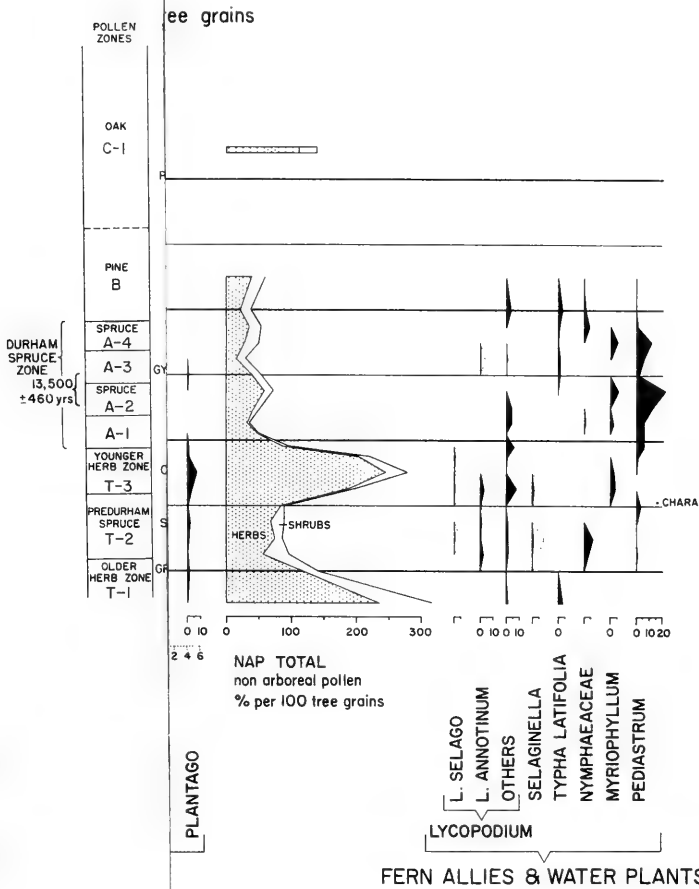

TOTOKET BOG—NORTHFORD, CONN.—CORE TOT B— Percent per 100 tree grains

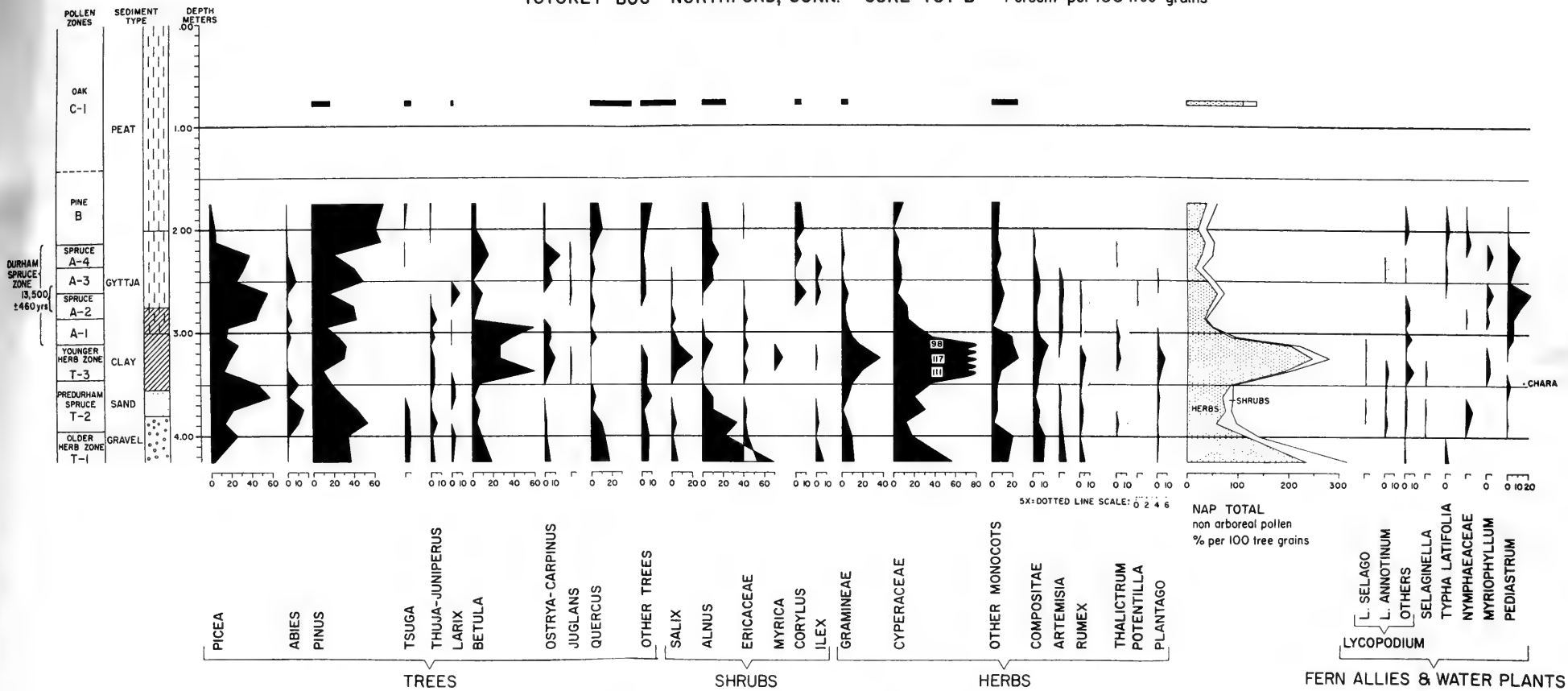

FIGURE 6.—Pollen diagram of Totoket Bog, Northford, Conn.

genera because, though one might be sure to what major taxonomic group the plant belongs, it is usually considered inappropriate to apply the names of living genera to such old material.

Identification of fossil forms in terms of modern species and genera requires careful comparison with a large-as-possible collection of modern pollen, prepared by acetylation from authentic herbarium collections (Traverse, 1955).

With proper preparation a fossil pollen sample may contain up to 1,000 grains per slide. If the assemblage represented is rich in types, it may consist of 60 to 100 forms, though usually it contains less. An estimate by eye of the relative proportions of all these types is usually not accurate, especially for the rarer forms, and instead it has become accepted practice to count 200 to 1,000 grains in order to compute the percent composition of a sample. Because the slide assemblage is mixed, systematic traverses of the preparation by means of a mechanical stage permit the observer to encounter a random sample. By performing counts in a consistent manner for each of several samples in a sedimentary sequence, and by converting the tallies to percent composition of the observed sample, quantitative data can be obtained. By plotting the data in graph form with the values for each sample arranged in a vertical series according to its placement in a section, the relative numerical importance of each pollen type at different levels in the section can easily be seen. Such a plot is termed a pollen diagram, an example of which is included as figure 6.

When the sample count includes 1,000 grains, percent composition data are statistically very reliable for both rare and common pollen grains. If the count includes 200 or fewer grains, the calculated percent composition involves a sampling error that becomes increasingly serious for progressively smaller counts, and is more serious for common pollen types in the sample than it is for rare ones. When two or more pollen diagrams from a deposit are essentially the same, reliability of the data is increased (Faegri and Iversen, 1950).

The pollen diagram shown in figure 6 represents an analysis of a 4-meter core in a late-glacial bog near Totoket Mountain, Northford, Conn. As a help in visualizing the sequence, a diagrammatic section of the core sediments from which the pollen samples were taken is shown at the left of this figure along with a scale to show depth below the surface of the bog. Plant genera observed in the samples are arranged from left to right starting with trees, followed by shrubs, herbs, and water plants. The relative amounts of different pollen types are shown as deviations to the right from the vertical axes.

The advantage of presenting data in a diagram is that at a glance one can easily see major trends, dominant types, and relations of sediment type to the pollen phases, and also observe the components

of a single sample by following one depth level horizontally across the graph. Interpretation of a complex pollen or spore diagram is facilitated by dividing the sequence into phases or zones, in order to outline further the major features of the sequence. Definition of zones can be based on any feature that seems pertinent, such as a numerically dominant genus, or presence or absence of critical though less abundant microspores. In our example, the zones entered on the extreme left of figure 6 are labeled for convenience by alphabetical symbols and are based on the dominant plant type or genus: T zones for predominance of shrubs and herbs, A zones for spruce (*Picea*), B for pine (*Pinus*), and C for hardwoods (here *Quercus*, oak).

From one or preferably more than one such fossil samples or sequences, inferences can be drawn about the type of plants represented, the general climate at the time of deposition, the environment of deposition, and the approximate age of the sample. Examples of such conclusions are discussed later in relation to paleoecological interpretation and correlation by pollen and spores. It might be said again, however, that the interpretation must recognize that the pollen and/or spore rain represented in the sample does not define the exact composition of the vegetation adjacent to the site of deposition. Qualitative changes with time shown in pollen or spore sequences are more meaningful than the composition of individual samples.

RECONSTRUCTION OF PAST ENVIRONMENTS

For paleoecological purposes, fossil pollen serves as a means of determining the botanical relations of the plants in the assemblage. Having identified the fossil pollen, the pollen analyst, under the assumption that plants have not significantly changed their environmental tolerances in time, can deduce that an environment like that now required by these plants once existed in the vicinity of the fossil locality. If a modern species is now limited in its distribution by specific factors such as temperature or rainfall, then from a Pleistocene occurrence of the plant one can infer rather precisely the climate at the time the plant grew. The validity of such conclusions increases with the number of different plants on which they are based. They are most exact for the Pleistocene and decrease in accuracy with increasing age of the sample.

Such precise climatic inferences cannot be made from plant assemblages of Tertiary age, but, because most modern genera (but not species) have existed throughout the Cenozoic along with gradually decreasing numbers of extinct forms, somewhat more general interpretations are possible.

Most of the plant genera of the older Mesozoic and Paleozoic are now extinct. Hence ecological evaluation of these old assemblages is

especially dependent upon correlative evidence from associated fossils and from the physical character of the deposit.

An example of the use of fossil pollen in reconstruction of a prehistoric human environment is the sequence described by Godwin (1948) for Shapwick Heath (bog), Somerset, England, where interesting Iron and Bronze Age artifacts have been discovered. The pollen, from a series of sediment samples taken at close intervals below, at, and above the levels where artifacts were found, documented a series of changes in the vegetation that revealed the nature of the human cultures. Interpretation of the resultant pollen diagram was based upon changes in the kinds and numbers of weed, forb, and agricultural plant pollen present in the section.

Less than half a meter below the bog surface were discovered the well-preserved remains of a log trackway (Westhay trackway) constructed of longitudinally laid birch timbers and small, more or less vertical stakes pinning these in place; the birch timbers showed clear ax cuts that by their nature could not have been made by a modern ax, but were characteristic of the marks left by certain ax types used in the late Bronze Age. Associated with the trackway timbers was a spearhead that was of late Bronze Age.

At other locations in Shapwick Heath, commercial peat-mining operations revealed no less than five food caches buried below the modern surface of the bog, and these are datable to the Romano-British culture by the coins contained in them. At other localities, a scabbard (La Tène scabbard), of late Iron Age, and also a primitive boat, 18 feet long, were discovered under several feet of peat. The archeological age of the boat is not certain, but the plant species present indicate that open water has been scarce or absent on Shapwick Heath since the time of the Westhay trackway.

In sediments just below the oldest of these artifacts (the timbers of the Westhay trackway), weed, cereal, and forb pollen types are present, and in sediments above the trackway believed to be contemporaneous with the late Iron Age, these same pollen types are especially numerous.

Pollen representing weeds and forbs in Shapwick Heath sediments include *Rumex*, *Artemisia* (sage), members of the daisy and lamb's-quarters families, and plantains. The most significant plantain species is *Plantago lanceolata* which elsewhere in European post-glacial sequences has been found only in sediments younger than Neolithic Age. It is a well-established fact that this plantain species has proliferated in Europe only in the last few thousand years, and that it is probably a weed associated with human disturbance of the vegetation. The cereals present include grasses and members of the barley group, which are difficult to identify to genus by their pollen.

Allowing for the possibility of burial of artifacts below sediments with which they were contemporary, the evidence from the Shapwick Heath pollen sequence indicates that clearing of the local forest was begun toward the end of the Bronze Age and just before the construction of the Westhay trackway. A later and more pronounced maximum of weed and cereal pollen in sediments of late Iron Age suggests that clearing and agriculture probably reached a peak of activity at that time. The occurrence of barley grain in the ruins of a local village of late Iron Age confirms the fact that agriculture was practiced during that era.

The archeological record of Shapwick Heath history ends with the Romano-British artifacts which are datable to the time of the dissolution of Roman power in Britain at the close of the fourth century A. D.

Pollen data from a peat bog near Northford, Conn., illustrate how fossil tree pollen can be useful in inferring the nature of prehistoric climate. In the pollen diagram (fig. 6), from this bog, tree-pollen curves plotted on the left include data for spruce (*Picea*), a genus that no longer grows in appreciable numbers in the State. During the deposition of zone A, which began some 13,000 years ago, spruce was the dominant pollen type, and therefore was probably the dominant tree in the local forests at that time. By comparison of the amount of spruce in zone A sediments with its density in pollen rain of areas to the north, one finds that the nearest comparable modern concentration of spruce lies in the Maritime Provinces of southern Canada. Because spruce distribution and abundance are controlled by growing-season temperatures, one can make the definite conclusion that July temperatures of southern Connecticut during the deposition of zone A were at least as low as those now found in the Maritime Provinces. These temperatures average 16–18°C. in July and are 3 to 4 degrees cooler than those now typical of southern Connecticut in the month of July (Leopold, 1957).

If their present ecology is well understood, microalgae or marginal water plants in the fossil assemblages are sometimes helpful in revealing the original hardness or salinity of the water. In the Totoket diagram of figure 6, water plants and algae, shown on the far right, include: chara and *Myriophyllum* (water milfoil), now characteristic of mineral-rich lakes; *Pediastrum*, a small floating alga that now prefers open water; and the marginal water plants *Typha* (cattail) and *Nymphaea* (yellow water lily). Remains of all these are especially prevalent in sediments of zone A. One can therefore infer that during deposition of zone A when the forests of southern Connecticut were predominantly spruce, this basin was a lake with waters

somewhat rich in calcium. The basin is no longer a lake, for peat has filled the depression to create a bog in which the peaty muck at the surface is rich in humic acids and low in minerals. Hardwoods rather than spruce now grow around Totoket bog. Hence it is clear that the old muds underlying the peaty surface of the bog contain a record of a climatic and aquatic environment strikingly different from modern conditions in the Totoket basin.

An outstanding example of the use of fossil pollen, along with fruits, seeds, and wood, in a broad approach to the reconstruction of a Tertiary (upper Oligocene) environment is the investigation of the Brandon lignite. This unusual deposit of brown coal, near Brandon, Vt., was first discovered about 100 years ago and served as the fuel source for an iron industry once the largest in the United States. Recent rediscovery and study of the lignite (macrofossils: Barghoorn, 1950; microfossils: Traverse, 1955) has resulted in the identification of more than 50 genera of flowering plants; about 60 percent of these are represented by pollen alone.

The affinities of the plants from the Brandon lignite reveal that ecologically they form a subtropical assemblage which probably grew under conditions much like those in the river swamps of the Atlantic-Gulf Coastal Plain. Such significant genera as *Liquidambar* (sweet gum), *Nyssa* (tupelo), *Cyrilla*, *Gordonia*, and *Engelhardtia*, now found only in much milder climate than that prevailing in Vermont, are represented by fossil pollen. In addition, presence in the flora of some genera now growing under warm conditions but only in southeast Asia, e. g., *Glyptostrobus* and *Alangium*, is proved by the occurrence of their pollen. The present ecology of these and the other Brandon genera is compelling evidence for the existence in Vermont in the early Tertiary of climatic conditions similar to those now typical for coastal Florida or South Carolina.

Pollen from the Tertiary brown coals in Europe has been intensively investigated (Thomson, 1953), but the known Tertiary vegetational history of the United States is as yet based primarily upon leaves and other macrofossils. From studies such as that of the Brandon lignite, it is clear that palynology can contribute to a fuller understanding of the evolutionary and migrational history of past and present vegetation by adding another category to the list of detached fragments from which the geologic record of plants must be deduced. The potential of pollen and spores in this respect arises not only from their occurrence in rocks that do not contain other plant parts, but also from the fact that a single slide may contain the pollen of 20 or more genera; a sample of this size is amassed much more tediously when dealing with plant macrofossils.

CORRELATION

The practice of dating rocks by the fossils they contain is based upon the fact that during geologic time the complex of factors affecting organisms has resulted in their evolution, migration, and extinction. Establishing the sequence of changes in individual categories and assemblages of organisms provides a basis for a relative chronology. The stratigraphic paleontologist can make correlations and age determinations by comparison of fossils from beds of unknown age with those from beds where the age is established.

The suitability of pollen and spores for geologic dating arises from several of the factors already discussed, namely, their small size, taxonomic individuality, resistance to degradation, and widespread distribution. They may be used in correlation either as a means for identifying botanically the plants they represent or as arbitrarily designated forms. In practice, a combination of the two is often employed. The botanical approach takes advantage of the fact that the times of appearance and disappearance of most of the major plant groups are known. Thus Carboniferous plant microfossils reflect the dominance of extinct arborescent lycopods and horsetail relatives along with many ferns and seed ferns. Within the Carboniferous, changes in generic and specific composition and relative abundance with time are sufficient to make the numerous plant microfossils in coal useful for correlating coal seams within a basin (Kosanke, 1950).

Permian and older Mesozoic rocks are characterized by the absence of many of the Carboniferous types and the increasing proportion of winged gymnospermous grains and cycadophyte pollen. Angiosperm pollen is not certainly present until early Cretaceous time and is not abundant until late Cretaceous time. Pollen from Upper Cretaceous rocks is predominantly that of extinct angiosperm genera; the floras assume an increasingly modern and more provincial aspect in the Tertiary.

Such floral changes are revealed, for example, within the Tertiary sediments of the Great Basin, where fossil pollen assemblages record major changes in the composition of the woody flora due to migration and to evolution. These changes are of the same nature and on the same order as the regional floristic changes already outlined from study of fossil leaves and fruits. As do the leaf floras, the Cretaceous and early Tertiary pollen assemblages contain many strange unidentifiable types, a few recognizable subtropical families or genera, conifers, some of which are now extinct, and a few warm-temperate trees that still grow on the North American continent but are no longer present in the local flora. Middle Tertiary sediments show several

broad-leaved genera that now grow exclusively in Asia and also woody types that are now temperate in their distribution. Late Tertiary pollen assemblages show progressively more modern temperate floras in successively younger sediments. Pleistocene sediments in the west contain an essentially modern flora that underwent north-south or altitudinal migrations during the several climatic changes of that interval.

Generalized floristic trends, such as those outlined above, can be safely used within a limited region, like the Great Basin, as a broad standard with which to evaluate assemblages of completely unknown age from the same area. This type of dating requires identification to modern family or genus, where possible, of the dominant fossil pollen forms.

A striking example of applied palynology has been described by pollen workers employed in petroleum geology studies in the Maracaibo Basin, Venezuela (Kuyl et al., 1955). By extraction of organic residues from cores as long as 3,000 feet that included sediments of Cretaceous and Paleocene (early Tertiary) age, these workers obtained characteristic fossil pollen assemblages that could be traced laterally from well to well for total distances of as much as 100 miles. Pollen zones marked by changes in relative numbers or qualitative composition of the assemblages in the long vertical sections were the basis for a subdivision of underground sediments that could not be successfully delimited by other means. By means of identical floral successions revealed by pollen, four facies provinces in the Tertiary of western Venezuela were correlated.

The lower parts of these cores are composed of shales deposited in a marine environment, as indicated by remains of marine algae and Foraminifera. The sediments that unconformably overlie these obviously marine (Cretaceous) beds are mostly nonmarine coal beds, sandstones, and fresh-water shales. A pollen zone boundary that was fundamental in the oil-geologic interpretation of the basin structure forms a nearly horizontal stratigraphic line that transects both the rough plane of contact between the marine and nonmarine beds and the irregularities of the textural sediment zones. The most reliable pollen zone boundaries were based on fossil pollen and spore types that showed a similar vertical succession over a very wide area; these types were assumed to reflect the regional vegetation changes.

Because of the apparent usefulness of stratigraphic correlation by means of fossil pollen and spores, many of the large oil companies throughout the world now have installed research laboratories equipped for the study of these microfossils in sediments pertinent to petroleum-geologic problems.

SUMMARY

Pollen and spores have the singular advantage of being the smallest plant components that can be linked taxonomically with the parent plants. Their production in large numbers, together with their buoyancy, has insured their representation in aerially deposited dust over wide areas. Resistance of pollen and spore walls to most degradative processes has resulted in their preservation in varied kinds of sedimentary deposits from diverse environments, often from deposits otherwise without fossils.

Rapidly expanding appreciation of the presence of these microfossils in geologic sediments, together with development of methods for their recovery and criteria for their utilization, have led to applications in archeology, paleoecology, and paleobotany, and in stratigraphy. The developing usefulness of pollen and spores in such fields as petroleum geology promises that in the future these small fossils will be even more widely employed in these and other areas of research.

REFERENCES

BARGHOORN, E. S.

1950. Geological and botanical study of the Brandon lignite and its significance in coal petrology. *Econ. Geol.*, vol. 45, pp. 344-357.

DIJKSTRA, S. J.

1951. Wealden megaspores and their stratigraphical value. *Meded. Geol. Sticht., S'Gravenhage, n. s.*, vol. 5, pp. 7-21.

DYAKOWSKA, J.

1936. Researches on the rapidity of the falling down of pollen of some trees. *Bull. Intern. Acad. Polon. Sci. et Lett., Cl. Sci. Math. et Nat.*, ser. B (I), pp. 155-168.

ERDTMAN, G.

1952. Pollen morphology and plant taxonomy. *Angiosperms. (An introduction to Palynology, I)*. 539 pp. Stockholm.

1954. Introduction to pollen analysis. 239 pp. *Chronica Botanica*, Waltham, Mass.

FAEGRI, KNUT, and IVERSEN, JOHS.

1950. Textbook of pollen analysis. 168 pp. Copenhagen.

FREY, DAVID G.

1954. A differential flotation technique for recovering microfossils from inorganic sediments. *New Phytol.*, vol. 54, No. 2, pp. 257-258.

GODWIN, H.

1948. Studies of the postglacial history of British vegetation, part 10. *Philos. Trans. Roy. Soc. London*, ser. B, No. 600, vol. 233, pp. 275-286.

HYLAND, F.; GRAHAM, B. F.; STEINMETZ, F. H.; and VICKERS, M. A.

1953. Maine air-borne pollen and fungus spore survey. 97 pp. University of Maine, Orono.

IVERSEN, JOHS.

1936. Sekundäres Pollen als Fehlerquelle. *Danmarks Geol. Undersøgelse*, IV Raekke, Bd. 2, No. 15.

KOSANKE, ROBERT M.

1950. Pennsylvania spores of Illinois and their use in correlation. Illinois State Geol. Surv. Bull. No. 74, 128 pp.

KUYL, O. S. ; MULLER, J. ; and WATERBOLK, H. TH.

1955. The application of palynology to oil geology with reference to western Venezuela. *Geologie en Mijnbouw*, n. s., vol. 17, pp. 49-76.

LEOPOLD, E. B.

1957. Comparisons by pollen chronology of late-glacial climate in eastern USA with that of the Alleröd in northern Europe. *INQUA, V Congrès International; Résumés des communications*, pp. 105-106.

MCKEE, E. ; CHRONIC, J. ; and LEOPOLD, E. B.

Sedimentary belts in lagoon, Kapingamarangi Atoll. (MS.)

PFLUG, H.

1953. Zur Entstehung und Entwicklung des Angiospermiden Pollens in der Erdgeschichte. *Palaeontographica*, vol. 95 (B), pp. 60-171.

THIERGART, F.

1949. Die stratigraphische Wert mesozoischer Pollen und Sporen. *Palaeontographica*, vol. 89 (B), pp. 1-34.

THOMSON, P. W.

1953. Pollen und Sporen des mitteleuropäischen Tertiars. *Palaeontographica*, vol. 94 (B), pp. 1-138.

TRAVERSE, A.

1955. Pollen analysis of the Brandon lignite of Vermont. U. S. Bureau of Mines, Rep. Invest. No. 5151. 107 pp.

VALLENTYNE, J. R.

1957. The principles of modern limnology. *Amer. Sci.*, vol. 45, No. 3, pp. 218-244.

WILSON, L. R.

1944. Spores and pollen as microfossils. *Bot. Rev.*, vol. 10, pp. 499-523.

WODEHOUSE, R. P.

1935. Pollen grains. 574 pp. New York.

Reprints of the various articles in this Report may be obtained, as long as the supply lasts, on request addressed to the Editorial and Publications Division, Smithsonian Institution, Washington 25, D. C.

The Influence of Man on Soil Fertility¹

By G. V. JACKS

*Director, Commonwealth Bureau of Soils
Rothamsted Experimental Station
Harpenden, Herts., England*

BY MAN, spelled with a capital M, I mean human societies, including men and women, cows, crops, microbes, cars, steelworks, and stock exchanges. By soil fertility I mean the capacity of a soil to produce living material, regardless of how the soil acquired that capacity. If one man treats a spoil heap with fertilizers he may produce a fertile soil within a year, but the fertility will be evanescent, and he will not find it worth his while to maintain it. But Man—human society—may judge it worth while to reclaim the spoil heap for permanent agriculture, in which case he sets in motion some long-term processes largely governed by such things as the output of cars, activity in the steel industry, and level of the bank rate. These are among the major factors which determine the influence of Man on the present-day evolution of our soil.

When a soil scientist studies the influence of a forest on soil formation he pays most attention to the influence of the tree canopy, which is the dominant living influence on the soil because it conditions the existence and activities of all the lesser living factors such as the ground flora, the fauna, and the soil micro-organisms. But when a soil scientist studies the influence of Man on the soil he gives all his attention to the direct operations of the farmer and cultivator, the downtrodden ground flora of the human forest, and ignores the dominant influence exerted on the farmer's daily and secular activities by social and economic emanations from the canopy of the towns. My theme will be mainly the influence of towns on the secular evolution of the soil.

In embryonic societies, before towns exist, nearly everybody is engaged in food production, agriculture is of the self-sufficient type, and

¹ Address delivered at the Sheffield Meeting of the British Association for the Advancement of Science on Thursday, August 30, 1956. Reprinted by permission from *The Advancement of Science*, No. 50, September 1956.

there is no incentive to increase soil fertility, though there is a need for the whole community to organize itself so that a minimum level of soil fertility is maintained. This need is the basis of the tribal organization of many primitive societies living by nomadic, shifting cultivation which allows the soil to rest and recuperate between short periods of cultivation. It was also the basis of the three-field system of communal agriculture which maintained soil fertility in feudal England or, rather, slowed down the inevitable soil exhaustion that had to accompany social evolution. In these predominantly agricultural stages of human societies Man is a consumer of soil fertility. He cannot help it, any more than a young forest can help taking more out of the soil than it gives back; he cannot help it even when he is armed with all the wisdom which past experience and twentieth-century science can give him—because it is part of the nature of economic Man.

It seems also to be the nature of part of economic Man to congregate in towns at a certain stage of his social development, and to abandon agriculture for more profitable pursuits. The growth of towns has a powerful effect on soil evolution. Towns create far more, and more concentrated, wealth than agriculture can create, a rising standard of living, and a greater demand for the produce of the soil. A small, but very significant, fraction of this town-made wealth flows back into the country, and the towns' demands for food, clothing, and, nowadays, the agricultural raw materials of industry make it profitable for farmers to produce as much as they can from their land. To begin with, this results in an accelerated exhaustion of the soil, but if the towns continue to grow in size and prosperity a stage is reached—and has been reached in every successful civilization—when it pays the farmers to intensify production, to increase output per acre and, therefore, to raise soil fertility. If it pays Man to increase soil fertility, he does it. That, I think, is the basic natural law governing the growth and survival of civilization.

A good example of the initial fertility-destroying and subsequent fertility-making influence of towns is afforded by the recent history of the United States. The drain on soil fertility to satisfy the demands of British towns for cheap food in the last century was one cause of the terrifying soil erosion which has afflicted the United States. But very recently a small part of the immense wealth produced by American industry has begun to flow back into the soil. Farmers are finding that it pays to conserve their soil and to raise its fertility. Soil fertility, measured by crop yields, is rising more rapidly in the United States than in any other part of the world.

Towns increase a country's soil fertility by enabling farmers to afford to put more into the soil than they take out of it. Fertility

cannot be increased merely by getting the soil to take in its own washing, that is, by self-contained or self-sufficient farming which, at best, returns to the soil only a part of what is removed from it. The fertility-producing farmer must be able to buy, or otherwise procure, fertility from outside and he must have a continuing economic incentive to do so. There are various ways in which farmers can acquire money and various forms in which they can buy soil fertility (by which I mean anything or any measure that will increase yields); but, in general, farming Man can earn enough not only to pay for his necessities and luxuries, but also to improve his land in the hope of further gain, only by selling to a stable and wealthy market—a town which produces many times more real wealth per acre than the best soil can. In this industrial age enough wealth is being produced in the towns and cities of the world to fertilize very large areas of food-producing land. Most of the people in the cities have enough to eat; most of the 60 percent of the world's population that are underfed are producers of food.

I have so far distinguished three stages in the evolution of soil under Man. First, there is the shifting-cultivation stage when human activity has only an ephemeral effect on the soil. This stage is associated with a low density of population, and may not occur in societies living in places, like Egypt, irrigated by fertility-producing water. Secondly, as and when population increases, permanent settlement occurs and soil-exhausting agriculture is practiced because society has few other sources of wealth than the soil to draw on. Society tends to develop a structure which prevents too rapid an exhaustion of the soil. This we may call the soil-exhausting stage. Thirdly, as the population increases further it congregates in towns, reducing the pressure on overworked, unimproved land, but gradually increasing the demand for its produce. Towns produce wealth from other sources than the soil, which enables them to pay for their demands and makes it profitable for farmers to satisfy them by investing money in soil fertility. We may call this the soil-conserving or fertility-producing stage. Society becomes urbanized and largely loses interest in agriculture, but wealth continues to flow from the towns into the soil. A state of equilibrium may be reached when the input of soil fertility by the towns is balanced by the output in rich harvests.

What happens subsequently is not clear. We have examples of all these three stages of social and soil evolution in the world at the present time, and we may have examples of a later stage of soil evolution under Man in the overpopulated, because underurbanized, regions of southeast Asia where nearly half the people in the world live. We do not know whether yields in India and China were once higher than they are today when they are much too low to support, except

in dire poverty, the mainly agricultural populations; but whereas yields in all industrialized countries have increased markedly within the last 50 years and are still increasing, they have not increased in India and China. In both countries, however, the present governments are aware of the importance of industrialization and getting people off the land as a means of raising the standard of living, which would lead to some improvement in soil fertility.

The different stages of soil evolution under Man are not, of course, distinct. They merge into one another, as do the corresponding stages of social evolution, and it is quite possible for all three (or more) stages to be apparent in one country at the same time—as, for example, in modern Ceylon, where shifting cultivation, soil-exhausting subsistence agriculture, and soil-conserving commercial agriculture are operating simultaneously. Western Europe is the only large area of the world that is at the climax of soil evolution; much of the rest is so young in human history that it is still in the soil-exhausting stage, a fact which affords an adequate ecological reason for the present worldwide prevalence of soil erosion. The soil-exhausting stage will pass, and one factor which is accelerating its passing is the widely felt fear that it may not pass.

A glance at the past and present histories of Man in different parts of the world will show that they all conform to the same general pattern in relation to the soil.

ENGLAND

The history of England affords an excellent illustration of the way in which soils have evolved under human society from their original forest-made condition of quite low fertility to their present man-made condition of very high fertility. Parallel with this soil evolution occurred a social evolution from a tribal to a feudal to a highly industrialized capitalistic society. In these parallel evolutions the outstanding influence on soil fertility was the growth of towns.

The first people to clear the English primeval forest were probably shifting cultivators. Then, gradually, an invariable system of settled agriculture developed, of which the most essential feature was the resting fallow. This "three-field system" was a characteristic of the feudal age. The land was worked according to a fixed set of rules, to prevent the otherwise rapid exhaustion of the land and the breakdown of the community. The rules not only checked soil exhaustion, but also prevented soil improvement.

The fallow, however, did not completely prevent soil exhaustion, and by the time the feudal period was coming to an end many of the open fields were getting into a bad state with increasing weediness and falling yields. As is well known, the early commerce of this

country was based on wool, and the rise of the wool trade gave a great impetus to the enclosure of common land which, after enclosure, was almost invariably put into pasture for sheep. Grass is the best soil improver known; indeed, it is noteworthy today that wherever soil improvement is being planned, from the Poles to the Equator, first reliance is placed on grass. At the time of the Tudor enclosures, at the end of the exhaustive stage of soil evolution, it was pressure from commercial interests, and against the will of the great majority of farmers, that gave the soil its first dose of fertility-producing medicine. Later, great improvements, which would have been impossible on unenclosed land, were effected in pastoral and arable farming, mainly with capital earned in the towns. Investment in soil fertility was profitable because the towns provided a market for all that the soil could be made to produce.

Large-scale investment in soil fertility of money earned in commerce and industry continued until about 90 years ago with immense benefits to both farmers and land. Then the opening up of the New World brought near disaster to British agriculture, and offered greater attractions than did British land for the surplus wealth of the towns.

However, the subsequent neglect of British agriculture, which lasted until 1940, had little effect on the inherent fertility of the soils because so much land went back to grass, which gave the soil a rest. If arable farming had been maintained at the 1870 level with insufficient capital investment, the loss of inherent soil fertility might have had serious consequences in the two world wars. At the present time the crying need of the soil is for capital which can only be provided in sufficient quantity by the products of industry. It is becoming evident that, in future, Britain will be unable to rely to the same extent as formerly on buying unlimited food from abroad, so more of the wealth of the towns may again be diverted into the soil. Already the state pours money into the land on a vast scale; the level of soil fertility—crop yields—would fall immediately if the state ceased to do so.

NORTH AMERICA

In North America the soil is going through a similar sequence of evolutionary stages under the influence of Man. Social development has been telescoped into a much shorter space of time than was the case in Europe. Most people would say that industrial progress has advanced further in America than in Europe, but it is of very recent date and the beneficent effects of American industrialism on the soil are only now beginning to be discernible.

At first there was a period of "shifting cultivation" as the frontier was pushed westward. The land was skimmed of its fertility and then

abandoned or passed on to another who continued the skimming process. The greater part of the habitable land was occupied within a century. Then followed a period of soil-exhausting agriculture when the unimproved soils were bled not only to keep their owners alive, but also to feed the teeming urban populations of Europe and thereby to provide some capital for founding American industry. The land got back little for what it gave, but in the mushrooming cities seeds were being sown which would bring forth a rich harvest of soil fertility.

The disastrous effects on unfertilized American soil of huge exports of food, mainly to Europe, are very evident at the present time in the widespread occurrence of soil erosion, a disease from which many other parts of the world are also suffering. Food exports, of course, were only one of many causes of the rapid exhaustion of American soils that in its turn was the immediate cause of soil erosion by the physical breakdown of soil structure. That all this erosion should have happened is usually regarded as unfortunate, sometimes as tragic, and occasionally as sinful. Taking a global view of agriculture, soil erosion is certainly a phenomenon of tremendous significance today. It has been described as a symptom of maladjustment between society and the soil, but I regard it, rather, as a symptom of a normal stage of the evolution of soil under Man's control. Human society destroys soil fertility before it begins to create it, and there is nothing society can do about it until it has created a great surplus of wealth, over and above what the land can produce, with which to fertilize the soil.

Unlike Europe, North America has not evolved a cast-iron social system to check the outflow of fertility from the soil. Events have moved too quickly. But in the 1930's the soil-conservation-district movement was started in the United States, by which the farmers of a district voluntarily organized themselves, with Federal and State backing, to farm according to established soil-conservation practices. The movement spread with astonishing rapidity, and today most of the farmland is included in soil-conservation districts. In many districts good intentions are more evident than soil conservation, but that the movement should have swept the whole country in less than 20 years is most significant. The much greater effect on soil fertility of a phenomenal increase in industrial production has to some extent masked the direct effects of soil-conservation measures.

Although the event is still too recent for us to be certain about its significance, the economic depression of the 1930's may have been the turning point in the evolution of American agriculture from soil exhausting to soil conserving. During the depression millions of acres of overworked land got a rest, and the virtues of grass as a protector of the soil from erosion and as renovator of soil fertility

became clear to all. As in our first agricultural revolution, the farmers did not like having to change their traditional ways, but they could not stand up to the harsh economics of the time, any more than our open-field farmers could resist the powers of enclosure. When the second World War came, food production was enormously increased, as it had been in the first war, but this time fairly adequate precautions were taken to protect the land from erosion, and soil fertility was not used up—indeed, it was increased by the greatly expanded use of fertilizers and other applications of science and technology. Since the war, crop yields have continued to rise, and now average about 35 percent above prewar. Farmers have had money to spend and to spare, and some of it has found profitable investment in soil fertility. Boom conditions, however, do not last forever. America is now producing more from its land than it can dispose of. What that portends for the future I do not know, but it suggests that American economy and soil are still far from a balanced equilibrium. The soil-conservation stage has a long way to go.

USSR

Data on the progress of agriculture in the Soviet Union are unreliable, but there is no evidence whatever of such great advances in yields and intensity of production as have recently occurred in North America. In Russia the towns do not provide surplus capital to fertilize the land; on the contrary, the land is starved of capital to feed the expansion of industry, as happened in the United States until a few decades ago. Russia is still in the soil-exhausting phase of economic development—indeed, in some respects it is still in the shifting-cultivation phase. If the industrial revolution is carried through successfully in Russia, however, the land should ultimately get some of the surplus wealth of industry in the form of capital investment and applied science, and the normal effects of industrialization on soil fertility should then appear. Russian soil science is remarkable in two ways. It is 25 years ahead of the rest of the world in its conceptions and 25 years behind in its application. The limiting factor to greater productivity is not lack of knowledge of the soil, but lack of capital as a fertilizer. To this might be added the apparent absence of all incentive to the collective farmer to improve the land. The present trend in Russia is toward the supersession of the collective farm by the state-owned, factory-operated farm. Collective land ownership, during the short time it has operated, has failed to increase soil fertility. It is quite possible that state ownership, which is in some ways analogous to the large-scale individual ownership which played such an important part in promoting soil fertility in England, may have similar effects in Russia. To the

western mind the much advertised project to reclaim 70 million acres of semiarid virgin land in central Asia for grain production seems a colossal waste of effort when so much more could be done by intensifying production on the naturally fertile and more accessible black earths of the Ukraine, but it must be remembered that so far the influence of Man on the soils of the Soviet Union as a whole has been very small, and parts of that vast country are still in the shifting-cultivation stage. There is still the urge to people the empty spaces, which appears again and again, and not only in Russia, in schemes to reclaim deserts or to settle the Arctic, and reflects the inborn longing of Man to be master of all he surveys.

One must recognize, too, that the Chinese Communist revolution, with its emphasis on industrialization, may bring new life to China's wornout soils, many of which seem to be in the last stages of decline after some thousands of years under Man's control. But the revolution has scarcely started yet.

SOUTH AFRICA AND AUSTRALIA

These two large countries are taken together not because of any similarity in their agriculture or soils, but because both are at the same critical stage of soil evolution. In both, soil exhaustion and erosion have been very severe and have caused the utmost alarm to farmers, financiers, and politicians. Indeed, the late General Smuts once said that soil erosion was bigger than politics—which meant something in South Africa!

Since the last war, however, a remarkable change in outlook has come over both countries. Immense progress, for so short a time, has been made in the reorganization of agriculture on a soil-conservation basis, particularly by the establishment of soil-conservation districts based on the American model, and by the intensification of agriculture and the introduction of ley farming. In both countries, too, agriculture has ceased to be the main occupation of the inhabitants. In Australia three-quarters of the whole population is now urban. In South Africa heavy industry produces more wealth than either mining or agriculture. Both countries have just reached the stage where the wealth of the towns can begin to fertilize the soil.

The voluntary communal control of soil erosion by means of soil-conservation districts, which has taken such firm root in America, Australia, South Africa, and also on European land in Rhodesia, seems to be the modern equivalent of the communal farming rules enforced to check soil exhaustion throughout feudal Europe. Land-use regulations, made to ensure the maintenance of soil fertility, are enforceable by a district's own laws, as the fallow was enforceable by manorial law. The old three-field system, however, merely prevented

soil exhaustion from going too fast. The soil-conservation district aims not only to prevent soil erosion, but also to build up fertility—which was impossible under the three-field system. The soil-conservation district may well turn out to be the characteristic not only of the final stage of the soil-exhausting phase in these rapidly growing nations, but also of the emerging fertility-producing phase. It was originally devised to check the precipitate exhaustion of the soil that, in the previous absence of any social control, was getting out of hand, but it is now being used everywhere to build up soil fertility. The soil-exhausting phase is merging into the fertility-producing phase.

In South Africa, in particular, the soil-conservation-district movement has swept through the country within the last few years only. A sudden impetus has been given to soil conservation, the results of which have not had time to appear, but there can be no doubt about the impetus which, again, may not last. It does seem, however, that the great progress and prosperity of South African industry are convincing farmers that it will pay them to invest in soil fertility, for example, by adoption of ley farming, by applying sulfate of ammonia to grassland in order to build up the soil's humus content, and other measures whose lasting efficacy cannot be known for many years. The significant fact is that the spirit of soil conservation is abroad, inspired by the money flowing from South Africa's young industries.

Australian pastoral and arable farming is also tending to become fertility-producing, though, as in South Africa, the revolution, if it is one, has scarcely begun.

The creation of more fertility than was present originally in Australia's soils has been made possible by using superphosphate to grow wheat and clover. Australian soils are among the oldest in the world, and were poor in the two essential plant nutrients, phosphorus and nitrogen, even before soil-exhausting farming began with the arrival of the white man. Wheat and wool have since removed much of the remaining nutrients. Deficiency of phosphate is widespread in both agricultural and pastoral land, and trace-element deficiencies are common. A general advance in Australian soil fertility can only be achieved by overcoming these deficiencies. There is also a deficiency of water that is more difficult to overcome, but Australia has a long way to go before water becomes the final limiting factor.

By applying superphosphate to the—to European eyes—miserable Australian pastures which, nevertheless, produce the finest wool in the world, dense crops of subterranean clover can be grown that enrich the soil with nitrogen, double or treble its carrying capacity, and provide humus for more intensive arable farming. By such simple

means, reminiscent of the introduction of clover into English farming, there are almost limitless possibilities for increasing the fertility of Australian soils.

Superphosphate, subterranean clover, and a few trace elements have the power to make at least much of southern Australia fertility-producing. But the existence of the means is not enough to effect the revolution. The high price of wool that resulted from the Korean war gave a great fillip to soil improvement, but will not last forever. The Australian people, however, are already three-quarters urban and are developing secondary industries which should produce a surplus of wealth with which to fertilize the soil. Australians occupy a huge continent and are concentrated mainly in five large cities. It remains to be seen how far the fertilizing influence of these five widely separated cities will spread into the outback, most of which is still in the shifting-cultivation stage.

TROPICAL LANDS

In the mostly thinly populated areas within tropical latitudes, Man has seldom succeeded in ousting the plant world from its dominant position in the soil's economy. The Indian subcontinent is the best existing example of permanent tropical agriculture that has continued for centuries. It is also one of the most densely populated of tropical countries. As elsewhere in the Tropics, the basis of this permanent agriculture has been paddy cultivation in which flooding suffices to maintain plant nutrients in the soil at a level adequate for at least subsistence production of rice. The example of other countries, like Japan and Australia, shows that rice yields could be greatly increased in India by fertilizers, mechanization, use of high-yielding varieties, etc., and there should be no difficulty in providing all the people of India with adequate food from her soil, if the wealth to fertilize the soil were there—which, of course, it is not. There is far too high a proportion of the people on the land for its efficient utilization, and they are too poor to fertilize it. The rapid increase in India's rural population within the last century seems to have accelerated soil exhaustion, at least as far as soil erosion is symptomatic of it. There has been no increase in average crop yields during this century. This may indicate the normal exhaustion phase of soil evolution under Man, to be followed by a conservation phase when the country has been urbanized and enriched by industry, or it may represent a later phase in which society is too old to adapt itself to the creation of soil fertility. The Indian Government is exerting every effort toward industrialization, wherein undoubtedly lies the main hope for the future fertility of Indian soil.

No other well-tried system of settled agriculture except paddy-rice growing is known that will at least maintain, if not increase, the fertility of tropical soil. Rice is the almost universal basis of settled tropical agriculture, as wheat is of temperate agriculture. The minerals in the floodwaters together, perhaps, with nitrogen fixed by algae often found on paddy fields usually suffice to maintain soil fertility under continuous cultivation for hundreds or even thousands of years without needing a very complex social organization to operate the system. Rice growing, with a little pasturage and livestock, can provide the minimum necessities of a settled tropical society. Otherwise, tropical agriculture is mainly of the shifting-cultivation type which precludes permanent settlement. A patch of land will be cleared and cultivated for two or three years, after which the available plant nutrients in the soil will have been used up, and crops will fail. The land is then abandoned for, say, 10 to 20 years, during which a secondary growth of vegetation will invade the soil, restore its fertility and make possible another short period of cultivation. Shifting agriculture is essentially exhaustive, the purpose of the abandonment of cultivation being to rest the soil and restore its fertility. Such a system can only work with a very low population density.

The impact of European civilization on the Tropics has greatly accelerated, but does not seem to have altered, the normal course of soil evolution under Man. European colonists cannot live by shifting cultivation, and they have tried with some success to introduce peace and better health into their colonies. Consequently, colonial populations have recently tended to exceed the limits at which the land can be rested long enough to restore its fertility. In every tropical colony (using the term in its widest sense) shifting cultivation is breaking down, and invariably and inevitably soil-exhausting settled agriculture is taking its place. Social and soil evolution is going through the normal stage of soil-exhausting agriculture, often accompanied by catastrophic soil erosion. The wealth required to create soil fertility and, still more, the demand for a high standard of nutrition from a large, well-to-do urban proletariat are absent. Until this demand appears there will be no incentive to bury money in the soil. To the few Europeans who operate highly capitalized plantations in the Tropics, however, the incentive of supplying their own urban markets, at home and abroad, is making itself felt.

We already have examples of intensive, fertility-producing agriculture in the Tropics that is basically similar to intensive European agriculture. In Southern Rhodesia a system of ley farming with large applications of nitrogen has given consistently high yields of maize, meat, and milk, and has improved the condition of the soil. But it has not been operated long enough to merit the term "per-

manent agriculture." The system is worked by a few progressive Europeans whose extra output is not sufficient to depress the price of maize. If every farmer followed suit there would be such a glut that all would be ruined—or at least would be unable to buy the necessary fertilizers. Under present conditions there would be insufficient demand for the produce. On the other hand, if all the people in the towns could afford to live well, their demands would tend to raise the price of maize, and some of the money they spent would flow back into the soil. All—and it is a big all—that Rhodesian soil needs to make it fertile is more and richer townspeople. Until it gets them it will have to put up with a good second best—the magnificent work of its agricultural officers. I should like to pay a tribute to this handful of key men who, throughout our tropical Empire, are smoothing out the agonies of the violent agricultural revolution which has followed the breakup of shifting cultivation, and are preparing the ground for the next, more prosperous stage.

Most colonial countries are now in the early soil-exhausting stage of evolution, and are developing social and agricultural systems which will slow down the loss of soil fertility that is bound to occur before the peoples are numerous and wealthy enough to enrich the land. Today, in most colonies, agricultural society is being reorganized, largely by agricultural officers, on a basis of soil conservation with laws, ordinances, sanctions, and subsidies to ensure at least the safety of the remaining soil. One can see social systems evolving in which it may be as difficult to mishandle the soil as it was in feudal England. In a recent flight over Africa what impressed me most was the quite frequent appearance of that most characteristic feature of soil conservation—terraced, strip-cropped fields. It was also the most beautiful feature of the generally dismal view one gets of Africa from the air. The open fields of England might have given a balloonist a similar impression 500 years ago.

These emerging social and agricultural systems, designed to conserve tropical soils, tend to be less flexible and more compulsive than those which are evolving in temperate regions whose inhabitants are politically and socially more advanced. They may become as unadaptable to purposes of soil improvement, as distinct from soil conservation, as was the rigid three-field system of England. We are acquiring the knowledge to make tropical soils fertile, but there are still lacking millions of people in towns producing nonagricultural wealth, the best fertilizer soils can have.

CONCLUSION

Throughout history the picture of Man in his relation to the soil has had certain common features: his first struggle to adjust himself to

the existing balance of Nature either by adopting shifting cultivation in forest lands or by nomadism in grasslands; then, with increasing population, upsetting the balance of Nature by the practice of settled, subsistence agriculture with social checks on the unavoidable exhaustion of the soil; then the concentration of the growing population into towns, the creation of new wealth in manufacturing, commerce, and the arts, a rise in the urban standard of living, a demand for more of the necessities of life, an overflow of wealth into the soil, and the creation of new fertility to satisfy the towns' demands; finally, the reestablishment of a biotic balance when the inflow of soil fertility is balanced by the outflow. As long as most of the population is urban there is no apparent upper limit to the number of people who can live in a region or country without exhausting its soil; but the present-day condition of southeast Asia suggests that a relatively low total population density can be a heavy burden on the soil when most of the people live on the land. By contrast, the countries showing the highest average soil fertility are the most densely populated and highly industrialized—Britain, Germany, Holland, Belgium, Japan—and agricultural Denmark, the exception to prove the rule.

Today, as a result of the rapid opening-up and development of a large part of the habitable land within the past century, most of the world is in the soil-exhausting phase, a fact which, unless viewed in ecological perspective, may lead to a certain loss of faith in the future of mankind. But it is a passing phase, which seems alarming only because it is happening over such large areas at the same time. Already we can see signs in some rich new countries that the soil-conserving phase is approaching. Will the world of a hundred years hence be able to feed the 6,000 million people who will then be in it? The answer is yes, provided most of them live in towns and produce enough wealth to pay for the food they need. If they offer enough money for their food, the food will be produced. As every farmer knows, it pays to fertilize when the market is good. That may, perhaps, be regarded as an oversimplification of the phenomena of civilization; nevertheless it explains quite a lot of them.

The Land and People of the Guajira Peninsula¹

By RAYMOND E. CRIST
*Research Professor of Geography
University of Florida, Gainesville*

[With 10 plates]

PARAGUAIPOA, market town of the Venezuelan Guajira, only 90 kilometers from the bustling, modern, oil-rich metropolis of Maracaibo, is in time and historical evolution several thousand years away. Beyond Paraguaipoa one enters a veritable cultural island, where the mode of life today is in many respects similar to that depicted in the Old Testament in the days of Abraham in the Old World desert of Arabia. It is a land of marked contrasts and violent extremes, where months-long droughts are followed by disastrous inundations; a land of shy but friendly people among whom the most violent blood feuds still flare up, where the biblical injunction of an eye for an eye and a tooth for a tooth is followed to the letter, unless retribution be made by the offender in the wealth of the land, namely livestock. Here also young women are frankly and openly acquired by purchase, in accordance with Guajiran law, and a man may have as many wives as his purse, his years, and his fancy will allow.

What are the factors, physical and cultural, that have made possible the formation and the preservation of a distinct society and culture in this little-known corner of South America? Already the Spaniards found a vigorous culture flourishing there, with its own language, institutions, and pattern of occupancy (though it was they who introduced the domestic animals on which most of the present-

¹The field and library work on which this paper is based was made possible by a grant of the Creole Petroleum Corp. Various departments of the organization cooperated in every way to further the undertaking. Thanks are due the ministries of the Venezuelan and Colombian Governments that helped to facilitate fieldwork involving movement back and forth across the frontier; also to Professor Lorenzo Monroy and Mr. E. J. Lamb, who were of assistance at every step throughout the author's stay in Venezuela. To Drs. Woodfin L. Butte and Guillermo Zuloaga, directors of the Creole Corp., the writer is especially grateful.

day wealth of the Guajiros is based). In this harsh and hostile desert environment a nomadic or seminomadic people, widely disseminated, has evolved and maintained a society with a highly developed group consciousness, though lacking, to be sure, many of the features characteristic of modern life. Although this land and this people have had an international boundary superimposed upon them, the people nevertheless continue to be Guajiros, speaking their own language, wearing their own dress, thinking of themselves, *not* as Venezuelans or Colombians, but as Guajiros. The Venezuelan and Colombian Governments, despite the political boundary line, have been forced to recognize local laws and customs and to grant a high degree of local cultural autonomy. The observer cannot but wonder how such tenacity of cultural traits has been possible. A succinct discussion of the physical and historical background, supplemented by observations in the field, may provide a basis for understanding some of the cultural forces that have been operative in the evolution and the cohesion of Guajira society, in spite of—or perhaps because of—extremely unfavorable physical factors.

Not so long ago, geologically speaking, the northeastern part of the Guajira Peninsula, La Alta Guajira, was probably an island, cut off from the mainland by a downfaulted block or graben, one side of which ran from the Cabo de la Vela south past Cerro La Teta and into the Gulf of Venezuela. Gradually, during Quaternary times, the shallow water covering this graben has been filled in with sediments deposited largely by the Río Ranchería and the Río Paraguachón as they eroded the Sierra Nevada and the Montes de Oca. Large sectors of the peninsula north and east of Paraguaipoa and Maicao and almost as far north as Cerro La Teta, are inundated even today during the wet season; the mountains from which most of the waters come can sometimes be seen as dark spots on the distant southern horizon. Most of this area is a vast plain of recent alluvium, covered with fine, fertile silt, and during pronounced droughts almost devoid of vegetation of any kind. It would be a garden spot if it could be irrigated rationally. A small amount of filling in has been carried on by the flash floods from the Serranía de Cocinas, at the base of which alluvial fans of coarse, unconsolidated debris have been formed.

The coastline along this area of alluvial fill, from Río Hacha to Cabo de la Vela in Colombia, and from Cojoro to Sinamaica in Venezuela, consists for the most part of sandbars flanked either by a fringe of sand dunes or by lagoons into which sea water is allowed to enter in order to be evaporated for salt. Dune formation is extremely active on the windward Venezuelan coast, from slightly west of Castilletes to Paraguaipoa. The dunes are moving inland at varying rates, depending on the strength of the wind locally. Scenes remi-

niscent of the sand wastes of the Sahara are encountered. In the shelter of the first line of dunes, in certain sectors, coconut groves have been planted, which anchor a considerable population. Slightly farther inland fields of millets can survive on the thin deposits of sand. Between Paraguaipoa and Sinamaica the sandbar borders long stretches of salt flats, which are exploited by the federal government.

The rugged part of the peninsula lies northeast of the well-defined fault lines, where mountains up to 900 meters in elevation are found. The cores of the Serranías de Cocina, de Jarara, and de Macuira are formed largely of igneous intrusives, and deposits of recent alluvium in the form of coarse rubble are found at the base of these low mountains. Extensive alluvial fans and terraces on the windward sides of these igneous formations seem to be at two levels, the first and higher level probably having been deposited when the mountains were higher and were therefore able to wring more moisture out of the winds. At the base of the leeward slopes, over the area surrounding the shallow, bottle-necked embayment known as El Portete, thick deposits of unconsolidated sands and silts have been laid down.

Just to the south of the Serranía de Cocina, striking almost east-west, is an especially good section of the Cretaceous, with the caves and sinkholes typical of Karst topography. The whole complex of igneous cores and of indurated sedimentary deposits is in places cut by dikes of igneous intrusives.

Roads and trails in this rugged, mountainous part of the Guajira traverse bare windswept terraces of recent alluvium, mesalike platforms of sedimentary deposits and of igneous extrusives, and canyons deeply incised into formations of limestones and shales, slightly dipping to vertical.

The Guajira Peninsula is a dry land, where evaporation far exceeds precipitation, as in so many parts of the globe at 10° to 15° north or south of the Equator. For where winds blow most of the time equatorward they are increasing in temperature, and as their temperature increases their capacity to absorb moisture increases. Hence they are drying winds and, when persistent, they create a situation in which evaporation is steadily greater than precipitation, with the result that desert or semidesert conditions prevail. This is true wherever such winds, the trade winds, blow for most of the year over a stretch of land of low elevation, whether it be in Africa or in America, whether at 10°–15° north or south of the Equator. It is true of the small, low-lying islands of the Caribbean, such as Curaçao and Margarita, as it is of most of Falcón, on the mainland of northern Venezuela, and as it is of the Guajira Peninsula. And the winds in the Guajira are vigorous enough to dry out and pick up sand from the beach for many miles and blow the particles in-

land, where they collect a few hundred meters from the shore in the form of dunes that gradually migrate farther landward.

It is during the months when the low-pressure belt is over the area—usually from October to December—that the Guajira gets its scant precipitation from convectional rains. It seems to be generally true that the less rainfall a region has the more irregular and unpredictable it is, and the Guajira Peninsula is no exception to this rule. When it does rain, however, the aspect of the landscape changes almost overnight. The seemingly dry and dead roots, plants, and shrubs at once begin to absorb the life-giving water and to send out shoots; seeds of grasses and forage plants, long dormant, begin to sprout, and many trees, long bare of leaves, are quickly covered with a canopy of foliage. And many are the Guajiros who hurriedly return to the land of their birth, to plant their patches of millets and corn, beans and melons. Then they enjoy a few months of comparative plenty, before the lean months, or years, again force them to migrate to Maracaibo, to the Perija foothills, or even farther from their beloved homeland.

To be sure, here, too, as in many parts of the world, is heard the familiar lament for “the good old days”—in the land of the Guajira it is for the good old days when the rain was more abundant than now and people could grow more crops. One is told of certain areas in which crops that were grown 20 years ago can no longer be grown, because the climate has become drier during the past generation. Perhaps the true reason is that the population, whose members are less inclined than formerly to cultivate marginal crops on marginal lands, is being siphoned off into other areas where economic opportunities are greater or more attractive. Some lands have become *economically* submarginal in an expanding national economy. Furthermore, the intensive health campaigns which have provided pure drinking water and diminished disease-bearing vectors, have resulted in a lowering of the death rate, especially the rate of infant mortality, with a consequent increase in population, which in turn increases the pressure on the food supply. At the same time more attractive economic opportunities elsewhere in the Republic, and the improvement of roads, coupled with the availability of motor vehicles, have helped to bring about a strong current of migration away from the Guajira. The net result is the same as if there had been an actual change in the physical climate.

Rights to real property, both surface and subsurface, are at the present time vested in the nation. Title to land, on which to build a house, in the vicinity of an urban agglomeration such as Paraguaipoa, can be granted by the Concejo Municipal. Over most of the Peninsula, however, land that can be used for agriculture is simply



1. Twilight in the Guajira.



2. The *casimba* at Cuitza, with a woman on the crude platform in the act of dipping up water to fill her jar.



1. Rubén Epieyú, fine example of the Guajira, in front of his home.

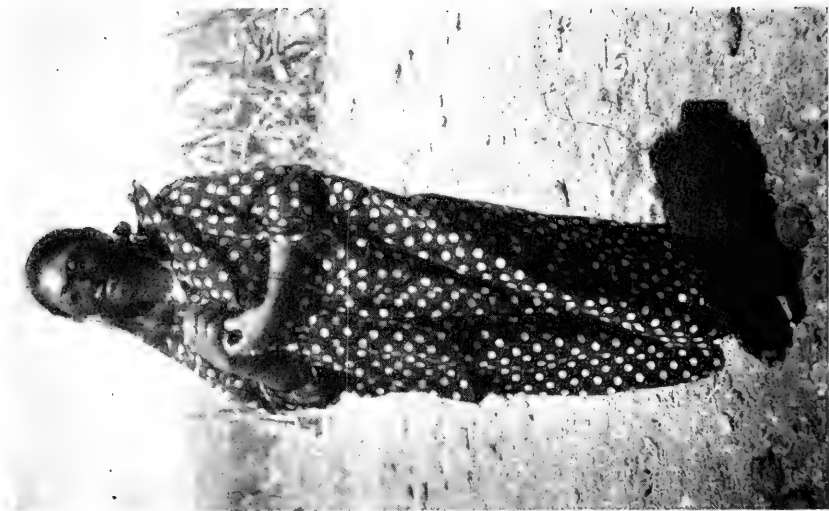

2. Young woman of the Guajira, with customary face painting—a protection against the strong rays of the sun.



1. Flocks of goats around a trough.



2. Watering goats by hand.



2. The fruit of the tall organ cactus is plucked by the use of a long pole with three tines at the end.



1. The Venezuelan and Colombian Governments have installed pumps powered by windmills at some of the more important watering places.



1. Children picking cotton from native plants which attain a height of 12 to 15 feet.



2. Spinning thread by hand from the raw cotton.



1. The weaving of a hammock is a cooperative family enterprise.



2. Large jars, or *tinajas*, are fashioned without the use of the potter's wheel.



1. Children help with the family food supply by gathering the fruits of the low, broad-leaved cactus.



2. Guajiros settled for the weekend in the *enramada* of a tiny store. Goat meat is drying on the roof at the right.



1. Drummer at a *chichamaya* dance, with a black-faced dancer in the background. The monotony of life on the desert is relieved by the gaiety and social enjoyment of the dance.



2. An aspect of the *chichamaya* dance. The man backs away from his partner, who tries to trip him up; when this happens he is out of the dance, and another takes his place.



1. Another aspect of the *chichamaya* dance. Observers may at any time become participants, and thus the fast tempo is kept up hour after hour.



2. The Guajiros resemble Bedouins as they ride across their trade-wind-swept peninsula.



1. A family on the move makes camp in a few minutes.

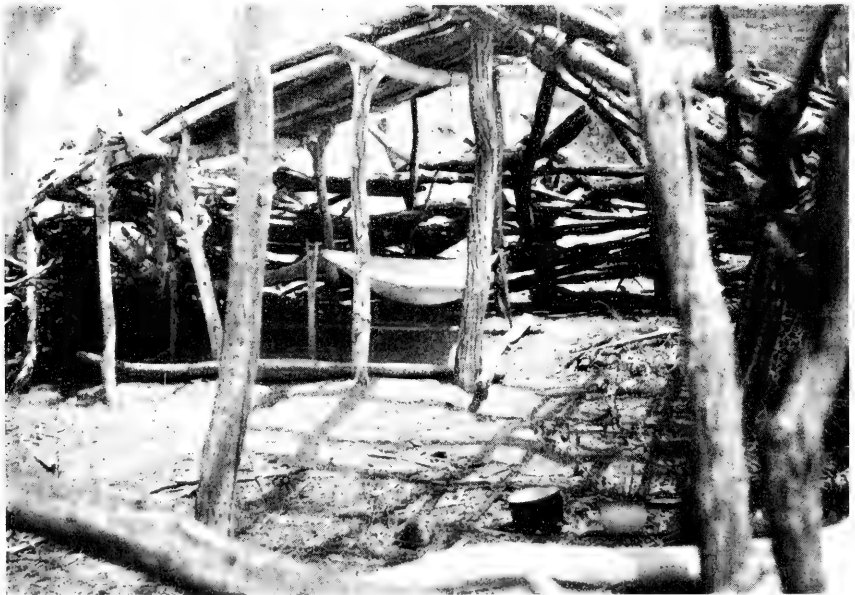

2. When he dies, the Guajiro is buried in the floor of his house where food and kitchen utensils are left for his use. The survivors abandon the house for good.

fenced in and cultivated. As long as the fence of organ cactus or thorn brush is kept intact and the land is actually cultivated, the usufruct thereof belongs to the cultivator. When the land is no longer cultivated and fences fall into disrepair, it reverts to the community, or goes to someone else who wants to work it. When the land is unfenced or unworked, the surface rights are assumed to belong to the collectivity, for animals graze over long distances. The international boundary is meaningless to the Guajiro; it is crossed by him and his flocks at will in the never-ending search for pasture and water. Indeed he takes no account of it in any of the phases of his seminomadic life. It is, in short, as if it did not exist.

Here, as in most arid regions, rights to water are more important than rights to land. Those who have become wealthy, those who own the largest flocks and herds, are those who have managed to get control of a permanent supply of water. They have either enlarged an old *jagüey*, or pond, or they have dug or drilled a well on which a windmill is installed to lift the water, or they have appropriated, and perhaps deepened, a *casimba*, or open, dug well.

The federal governments are cognizant of the importance of pure drinking water for people and for their animals, and the work being done by the Venezuelan Ministry of Agriculture and Husbandry—drilling wells, installing windmills, digging large *jagüeyes* and *casimbas*—is carried on with the idea that the water will be available at all times to the collectivity, on equal terms to all. (Pl. 4, fig. 1.) In the Colombian Guajira, the federal government is making extensive use of modern heavy equipment to build reservoirs—an improvement over the old-fashioned *jagüey*—which are filled when it rains, and some of the old *casimbas* are being deepened and lined with cement walls. Whether the water is lifted by wind power or by human brawn, these watering places are still among the most important and the most colorful of the foci or community centers where Guajiros congregate.

In all probability the cultural factor of greatest significance in the life of the Venezuelan Guajira of recent date has been the construction of the good, all-weather highway from Maracaibo to Paraguaipoa. In many parts of the world, when highways have been built into fertile, sparsely inhabited regions, settlement immediately follows.

One of the most notable examples of this phenomenon is to be found along many kilometers of the newly constructed Carretera Panamericana south of Lake Maracaibo, where what was only a few years ago dense tropical rainforest has already over vast stretches been converted into cattle ranches. But a highway is for two-way traffic. If it extends from a highly developed area to one which is poor, in

which it is difficult to make a living, or in which the political climate is unfavorable, then there tends to be a flow of population away from the poorer area toward the more highly developed one. This trend has been marked in the Guajira, which has been a kind of human reservoir in which the pressure of population upon the physical resources has been greater than it has been elsewhere in the nation. When such a region is tapped by a road, pressure is released by the migration over it of a part of its population. Witness the great exodus of Guajiros to Maracaibo, to the cattle ranches of the foothills of the Sierra de Perija, and toward other parts of the republic. The French in North Africa constructed magnificent highways into the great desert of the Sahara, thus facilitating the migration of hundreds of thousands of Bedouins into the Atlas Mountains and even into the cities of Morocco, Algeria, and Tunisia. Be it noted that these liberty-loving nomads have proved to be some of the most vigorous fighters against French colonialism.

The Guajiro equivalent of the old saying that "all roads lead to Rome" would be that "all trails lead to Paraguaipoa." Over the entire peninsula there is a ceaseless coming and going, both diurnally and seasonally, on the part of shepherds in search of water and pasture for their flocks of sheep and goats, but when animals are ready for sale, they move gradually toward the brisk market in Paraguaipoa, as inevitably as water runs down hill, in response to the pull of the high prices obtaining there. Flocks vary widely in size from those of two, three, or five animals to flocks containing scores. Animals are sometimes taken "in trade" by the owners of the little stores scattered around the peninsula and are by them driven or shipped by truck to Paraguaipoa. At other times the owners themselves drive their flocks to market. Setting out with their entire families, on foot, on horseback, on burros, they may take days or even weeks to arrive, camping each night on the way where darkness overtakes them, for they allow the animals to browse leisurely as they move along. On the outskirts of Paraguaipoa, all through Saturday afternoon and Sunday, flocks continue to arrive, and the picturesque shepherds and their families establish themselves on the windswept plain in preparation for the big Monday market day. At night for a radius of several kilometers west of Paraguaipoa the sand is dotted with campfires, around which families and friends gather to eat and drink and gossip. Early Monday morning merchants from Maracaibo come in by truck, buy up animals in lots, and return with them to the city the same afternoon. After selling their flocks, the Guajiros wander around in little groups; they buy yard goods and foodstuffs—*panela*, crude sugar, cooking oil, and other necessities—and by late afternoon they are ready to begin the long trek back to their homes in the bush.

The feeling that comes over the traveler as he leaves Paraguaipoa to enter the desert of the Guajira is in many respects comparable to that experienced by one boarding a ship. As the ship puts out to sea the traveler is effectively cut off from all that goes with his modern world; he will receive no letters, friends cannot drop in on him, and he cannot be reached by telephone. Similarly, as he moves out into the desert beyond Paraguaipoa, he realizes that he is, as it were, isolated and on his own for as long as he stays away from that narrow black strip of asphalt that ties him to Maracaibo and to all that is associated with modern urban life: juke boxes and traffic jams, cocktail parties, and a kind of breathless living full of forced and synthetic enthusiasms. In the desert one must be self-sufficient, one must live on his own inner spiritual resources and not be dependent on his fellows for companionship or excitement. And as night overtakes him, and the sun goes down behind the giant organ cactus, and the stars come out so bright and seemingly close enough to touch, and the songs of the birds are stilled, then the traveler feels that he is indeed alone. (Pl. 1, fig. 1.) Only the persistent trade winds continue to hasten on about their business, blowing through the scantily leaved trees and bushes. What a haven then the solitary thatched hut, from which the friendly and hospitable Guajiro host greets the traveler with the words *anshi piá*—"You have arrived"—the simple statement that serves as an invitation to stop in his humble home! And indeed the house is usually equipped to take care of friends and strangers, nomads or seminomads like himself, for the *enramada*, or framework of upright posts covered over with thatch of palm or slats of the organ cactus, is placed just outside most Guajiro dwellings, and it is here that the traveler swings his hammock, whether he be a traveler who rests there a few hours in the afternoon, the late-comer who stays all night, or the relative or friend who may tarry for days or weeks.

More important than the market, as centers of daily intercourse, are the widely scattered waterholes. In fact, a large part of the life in any desert area is carried on around springs and wells, natural or manmade, be it in the Guajira or in the Sahara or in Arabia Deserta. Since time immemorial the Guajiros have dug wells during the long dry months in dry river beds, or in alluvium or in sand dunes, in order to reach the life-giving water. As the water table goes down, the well is simply dug deeper. These waterholes are known as *casimbas*. People come to them in a constant stream from many kilometers in all directions. If the *casimba* is deep, a crude scaffolding is built out over it so that the continuous procession of men and women can walk out over the water and lower their jars, buckets, or cans to fill them. (Pl. 1, fig. 2.) At a little distance

from the *casimba* itself troughs are set up from which goats, sheep, donkeys, and cattle drink, and *bateas*, or wooden basins, are filled with water in which clothes are washed and small children are bathed. (Pl. 3, figs. 1 and 2.) After the people have slaked their thirst and that of their animals, and have bathed and washed their clothes, they load their donkeys with great jars of water to be used at home, often many kilometers away. The places of those who leave are taken by those newly arriving, and the lively pageant continues throughout the day. Similar scenes are enacted around the springs or oases of the Sahara and Arabia.

The grim struggle for the barest existence—for mere survival—is to be observed in the life of plants and animals as well as in the life of man. Many trees and shrubs are thorned, or of bitter taste or pungent smell, as a protection against enemies, and most of them are scantily leaved and of thick bark, in order to conserve all the moisture possible. The struggle of man with his environment is no less grim. When the drought is sore upon the land, and food supplies dwindle rapidly with no possibility of immediate replenishment, small children rove the sectors of flat-leaved cactus, the fruits of which they knock off into gourd bowls with sticks. When the bowls are filled they empty them on the ground and roll them about with twigs and thus remove the protecting tufts of tiny fine spines. All day long the children gorge themselves on the luscious fruit and in the evening they take their sacks and containers to their homes, where the parents eke out their frugal meal with these fruits. The fruits not eaten raw are peeled and cooked and placed in large earthen jars to ferment and form *chicha*, a drink highly prized by the Guajiros.

Over the centuries poor children have often been bribed or forcibly caught by so-called civilized people to be sold into slavery. Hence their parents warn them to be wary of strangers, and fill their tender minds with horror tales about kidnappings, actual or invented; the vivid imaginations of the children invest these accounts with all sorts of fiendish overtones. The result is that when a stranger comes upon these children in the bush, they frequently take to their heels and flee like wild animals. This happened on one occasion when at our approach four children were surprised gathering cactus fruits. Two of them took off through the scrub like rabbits and were not seen again. The two others had left their fiber bags and gourd shells of fruit near the road, and, fearful of losing their prizes, they stopped a few hundred yards away and looked back. The kindly, tactful interpreter was gradually able to convince them that we meant no harm. Little by little these two urchins, burnt black by the broiling sun of this part of the world, and ready to fly at the slightest false move on our part, edged back to their belongings and talked to the in-

terpreter, who manifested great interest in the fruits and in how they were gathered. By his gentle demeanor and the distribution of candy at a propitious moment, he gradually got the elder of the two—a charming little girl, at first scared half to death—to pose in the act of knocking the little fruits into the gourd, and to explain the whole process of gathering them and of making *chicha* out of those not consumed raw. (Pl. 7, fig. 1.) One's faith in humanity and its future is immeasurably strengthened by observing these children, conditioned from their tenderest years to assist uncomplainingly in the ceaseless struggle for survival where nature is so barren and niggardly.

The harshness of the physical environment predisposes the sparse population to a nomadic existence (pl. 10, fig. 1), but cultural factors as well are operative. One wonders why, for instance, with so much space available, the Guajiros live in tiny cramped huts, all packed tightly together. To this question my interpreter answered with two words: poverty and custom. The Guajiro is so poor that he cannot afford to construct a roomy, solidly built house. And why should he? For whenever a death occurs in a house the family abandons it, and no good Guajiro would run the risk of living in the house again. (Pl. 10, fig. 2.) After a death the various parts of the dwelling, with the *enramada*, are used for a while as a place in which to receive relatives and friends from a distance, but after three or four days or at most a week, when the *velorio*, or *lloro*, the wake and reception, are over, the family moves away, at least 2 or 3 kilometers, and builds another house. Near Cojoro, a new house, substantially constructed, with cement floor and walls and a tin roof, was abandoned by the owner, after the death of a son, and left to fall into ruin. The Indians who have migrated to Maracaibo, or who have absorbed Spanish culture, do not, to be sure, move from their house when a death has occurred. My interpreter told me that he would not leave his house because of a death, but his father-in-law, a wealthy Guajiro, moved from Jepí to Cojoro, 30 kilometers away, when his eldest daughter died in childbirth, and when his second daughter died of galloping pneumonia he moved another 30 kilometers to La Gloria near Paraguaipoa. Thus a basic cultural factor orients the people toward nomadism or seminomadism, rather than in the direction of a sedentary life. Such a factor will remain potent long after heroic attempts have been made to make the people sedentary by digging new wells, teaching new techniques of dry farming, and so on.

Another factor that has favored a certain amount of migration or seminomadism is the *pito* or *vinchuca*, a kind of outsized winged bed-bug, found in many sectors. Its normal habitat is the thatch roofs or the cracks in the daub-and-wattle walls. From their hiding places

these vermin come out at night, descending the ropes that sustain the hammocks or crawling out to the sleeping mats on the floor, and feed on their sleeping hosts. It is said that the kings of France moved from palace to palace as the bedbugs along with other vermin became so numerous as to make sleep impossible. By the same token the Guajiros are not averse to migrating in order to flee from the ravages of these revolting pests, which in Brazil and in the western llanos of Venezuela have been found to be the vectors of the Chagas disease, a close relative of African sleeping sickness. Fortunately the construction of houses with cement floors and walls and tin roofs, and the widespread use of DDT, are gradually diminishing this dread pest.

The Guajira is a land of hammocks, in which people sleep, sit, and spend their leisure hours, in which children are conceived, and in which old people breathe their last and are buried. As soon as a baby is born in a Guajiro household, it is put into its own diminutive hammock; when visitors arrive at a Guajiro home, hammocks are immediately hung for their comfort. Chairs are rarely seen and even more rarely used. The making of hammocks in the home is a craft learned early by the womenfolk and practiced all their lives. They are of two types, the closely woven *hamaca*, and the looser-meshed *chinchorro*, both worked with elaborate designs and gay color combinations as well as of solid white. Some of the handsomest hammocks made anywhere in the Americas are turned out on primitive hand looms by these master craftswomen. The making of a fine hammock, a cooperative family enterprise, requires from one to several months, depending on the number of women or girls who work on it. (Pl. 6, fig. 1.) As they find some spare time between their other household chores, the womenfolk sit down on the floor in front of the loom, one working at it now alone, now accompanied by her mother, her sisters, or other female relatives. There is no deadline or fixed date on which the work must be finished, and much friendly gossip is exchanged as the chore progresses and as deft fingers move so rapidly at their task that their manipulations are hardly visible to the naked eye.

Guajiro women wear the *manta*, a kind of loose, flowing, long-sleeved Mother Hubbard, formerly of coarse, homespun cotton cloth and simpler cut, now usually of imported yard goods of bright hues and lively patterns. Under this garment it is customary to wear only a sort of bikini, a wide band of cloth held by a *cirapo*, a belt made of many strings of beads. In former days the principal female garment was a homespun cotton tunic, slipped over the head, or merely an ampler breechcloth (the latter garb appearing in pictures of only a quarter of a century ago). This has given way in large part to the more elaborate *manta*, an adjustment to the climate in many ways

similar to the loose-flowing robes of the Bedouins. Indeed when traveling on their donkeys, with a billowing cape or *pañuelo* over their large straw hats flapping in the vigorous trade winds, they resemble the Old World Bedouin women. (Pl. 9, fig. 2.) The *manta* and its forerunner, the tunic, betray the "civilizing" influence of the missionaries.

The men wear a very brief *guayuco*, or breechclout, so curtailed as to make a bikini bathing short seem like a full-dress uniform. The *guayuco* is secured, front and back, by a broad, bright-colored, finely crocheted belt, which is wrapped around the waist and from which the gaily tasseled, crocheted money bag hangs down at the side. (Pl. 2, fig. 1.) Bag and belt, worked in intricate patterns and vivid color combinations, are made by each Guajiro woman for her husband. At the present time, especially for wear in town, most of the men have adopted the shirt, and they often cover their legs with a short draped skirt of yard goods or with trousers, but at home or traveling across the desert many still wear only the *guayuco*. Men, as well as women, are bedecked with beads and jewelry.

The most humble hut may be the center of a household industry, or craft, or of many industries. There is, to be sure, a certain amount of specialization in each home; frequently, however, a number of activities are engaged in simultaneously in the same house. One person will be laboriously seeding by hand cotton bolls picked from bushes in a tiny plot nearby (pl. 5, fig. 1); another will be spinning thread with a primitive hand whorl or spindle (pl. 5, fig. 2), or weaving a hammock on a hand loom from spools of thread already spun, while still another may be making or polishing clay pots before firing them. In the kitchen, at the same time, bitter yuca may be in process of being ground for the manufacture of food or starch. Bitter yuca is used for food here as it is in so many parts of tropical America, and the juice, which is poisonous unless processed, is made into a pleasant, refreshing beverage which is drunk like *chicha*, the fermented liquor made from corn.

Water containers, one of the basic necessities, particularly in a desert area, are of several kinds, natural and manmade. The hard-shelled fruits of the *totumo* tree furnish small containers of varying sizes and shapes; coconut shells are fashioned into simple spoons and cups, and a vine similar to a squash or pumpkin vine produces the *amuro*, a huge green pear-shaped fruit with a hard shell, which, when cleaned of its pith and seeds, will hold a gallon and a half to 2 gallons of water. In shape it is very much like the jars of clay, which are made here and there as a household industry. The process of making these earthen jars is complicated and time consuming and it is carried on under extremely primitive conditions. (Pl. 6, fig. 2.) Clay is

brought in on donkeyback from some distant deposit of clay or bed of indurated, clayey shale; it is ground into a powder in a hand mortar, mixed with water to achieve the right consistency, and laboriously, but most dexterously, built up by hand, without the use of the potter's wheel. Once properly fashioned, the jar is dried in the sun for a day or two before it is carefully polished by scraping and sanding, and then crudely painted with *bija*, a natural-colored red or brown clay. After this it is ready for firing over a slow fire of dried cow dung, the pieces of which are still a little green inside in order to make a slow, hot fire. It is difficult to conceive the miserably puny output of a few jars a week that results from this toilsome labor. A large jar holding about 3 gallons sells for a dollar to a dollar and a half, depending on whether the area is under the influence of the Colombian peso or the Venezuelan bolivar. These jars may be fitted into openwork fiber bags which can be hung onto the pack saddles of donkeys for transport over long distances.

One pottery maker complained that the light had gone out of her life and that she worked on in darkness because her two daughters had left, together with a cousin, in a truck for Ziruma (the Guajiro slum section of Maracaibo), and had not been heard of since. They seemed to have been swallowed up, and try as she might she could find no trace of them. She said that she had cried till the fountain of her tears had dried up, and that life held little attraction for her if she could not find her daughters. Sad and pinched were her features as she tried to force a smile of gratitude when she was offered a little candy and tobacco. She was somewhat vainly hoping to be able to make a better living so that her one remaining daughter, now 10 years old and soon to change into a woman, would want to stay on with her and would not turn her thoughts to leaving. She fervently yearned to keep some blood relation with her, to share her life and her work, for at best she could look forward only to a penniless and friendless old age, living alone in the vast, immutable desert, unfeeling and inscrutable, with the trade winds soughing through the spiny branches of the giant organ cactus. She was the epitome of tragedy, of the grief of a mother at the loss of the children of her womb, of sadness as immemorial as man on this earth, and as poignant as the immortal themes rehearsed on the Greek stage during its Golden Age.

One of the most interesting of the Guajiro customs is that of the *encierro* or *blanqueo*, the period of sequestration or confinement of several months, or even years, for the girl during puberty, commencing when, as they say, she begins to "*formarse*"—to acquire a woman's figure—and lasting from one month to two years, the length depending somewhat on her social position. During that time she is kept indoors and is not allowed to see men or to be seen by them. She

learns and practices, in what is a period of intensive domestic training, the arts of cooking, making *chicha*, and weaving hammocks. The first hammock she completes is her own, to be put by for use in her future home. Kept out of the strong wind and the blistering sun, her skin becomes pale, soft, and velvety, and when she comes out of the *blanqueo* she is ready for sale (somewhat as in our society a girl is ready for the marriage market after her "coming out" party).

A man buys a bride for a specified number of sheep, goats, cattle, and donkeys, or their cash equivalent. His friends help him in the task of arriving at the bride price, one giving a sheep, another two donkeys, another ten goats, and so on. In our society at the time of marriage, wedding invitations are sent out, resulting in presents from friends for the future household, whereas the prospective Guajiro groom receives actual, timely assistance from his friends in something that counts in acquiring a wife—livestock. If the bride is the eldest daughter, her price goes to her father and it cannot be less than the price he had to pay for her mother. The price of the other daughters belongs to the mother or to a maternal uncle. The bride price varies from a few goats to as high as 15,000 bolivars (about \$5,000), depending mainly upon the wealth and standing of the bride's family. Polygamy is an established practice among the men, some of whom are known to possess as many as 20 wives. Even to poor men plural wives are an asset, for women not only perform the laborious household chores but work the fields as well. A few Guajiros are famous for maintaining 10 or more wives in one household; husbands in general, however, take the precaution of keeping their wives in widely separated establishments.

The diet of the vast majority of the Guajiros is limited. Malnutrition and actual hunger are not uncommon during dry seasons, when the meal may consist of water sweetened with crude brown sugar, and perhaps wild fruits in season. In periods of prolonged drought many are the days when whole families must subsist on the fleshy pulp of the organ cactus, which is cooked to make it edible—a filling, however bitter and unpalatable, dish. When the rains come, food crops such as corn, beans, pumpkins, and millets thrive; corn and millets are used also in the making of the refreshing *chicha*, and it is said that millets produce a drink even more pleasant than corn. Bitter yuca (*Manihot esculenta*) is able to survive the drought in certain plots of alluvial soil. The small fruits of the round-leaved cactus, as has already been related, are used both for eating and for making *chicha*. When the *datos*, or fruit, of the high organ cactus are in season, they are eagerly sought for by all, and many go equipped with a long stick with prongs on the end with which to gather the fruits as they come upon them. (Pl. 4, fig. 2.) Along the

sectors of the coast where coconut palms thrive, these trees provide one of the principal crops, but only one with some financial backing can undertake to plant a grove, because his family must somehow live while waiting the 3 or 4 years until the trees begin to bear. In these groves hogs are fattened on the residue of coconut meats after the oil has been extracted; they are kept in pens off the ground so that they cannot run off the fat they accumulate.

In recent years there has been a steady rise in the high rates of natural increase among this population, inured as it is to extremely unfavorable living conditions, in spite of dire predictions to the contrary.² Those who live through infancy are tough—they prove it by their survival. Moreover, interest in improving general health conditions, particularly in the field of infant care, has been aroused on a national scale, with the result that in the Guajira, too, the rate of infant mortality, though still high, has been greatly decreased. Government-sponsored public-health measures are being pushed. Even in remote corners of Venezuela houses are regularly sprayed with DDT to eradicate malarial mosquitoes, as well as other household vermin. The drilling of wells and the installation of windmills, in many sectors of the Guajira on both sides of the border, to provide an adequate supply of uncontaminated water for human and animal consumption, has gone a long way toward decreasing the incidence of gastroenteritis, dysentery, typhoid, and other water-borne diseases, which are still among the leading causes of death.

The per capita consumption of alcohol in the Guajira appears to be exceedingly high. Each little store lost in the immensity of the bush, even when its entire stock is not worth more than a few dollars, has on hand a barrel of firewater. The tired wayfarer or visitor often is proffered an alcoholic drink, or a dozen drinks, rather than food. Tremendous quantities of beer and hard liquors are drunk with no thought of eating anything at all. On one occasion, my chauffeur and his host (the husband of his cousin), while waiting for breakfast, tossed off six cold beers, presumably by way of recovering from the long bout of the night before. As a binge continues on into its second or third day, or longer, less and less thought will be given to the consumption of solid food. After an Indian has performed a piece of hard manual labor—changing and repairing the tire of a truck, for example—it is customary to give him a shot or more of powerful firewater, rather than a substantial meal, by way of compensation. To be sure, the reward of a drink has become so common and accepted that it would perhaps come as an unwelcome innovation if food were offered instead. One cannot but feel, however, that a half-and-half

² Weston, Julian A., *The cactus eaters*, p. 130. London, 1937.

arrangement might well be substituted, for a gradual shift from strong drink to wholesome food would certainly be a step in the direction of increased hours of productiveness—one might even add, of consciousness, in view of the long hours and days that are passed by all too many, and too often, in a sodden stupor. Nor is it a happy sight to see a group of Guajiro men, just returned from Maracaibo with a neat sum of hard-earned bolivars, spending their savings of 6 months or a year in a week's carousal, on their way home, in some tiny country store.

These thatch-roofed, or at present more often tin-roofed, little stores, seemingly lost in the vast expanse of scattered bush, act as community centers; along with the waterholes and the large markets of Paraguaipoa and Maicao, they are the economic and social foci of the population of seminomadic herdsmen and of more or less sedentary people anchored to their small garden plots and their looms. The forlorn, lackluster look of these little centers during the week has nothing in common with their appearance on holidays or weekends. As early as Friday families of Indians from outlying areas begin to arrive, silently stretching their hammocks, spreading their provisions of dried goat meat on the roof of the *enramada* or on the branches of a convenient thorn bush, stacking the fiber bags of their few belongings in piles nearby, and otherwise making ready to spend several days. (Pl. 7, fig. 2.) So much of their lives is nomadic that it is easy for them to make themselves at home wherever they are. They bring to the little store the goats, sheep, or lambs, the calves, chickens, or eggs they are planning to turn into cash. All too often they take their pay in hard liquor or in flashy trade goods they may want but do not particularly need. As the day wears on, little clusters of people form around a rickety table in the lean-to of the store itself, around hammocks in the *enramada* close by, or in silent circles under the branches of the scant-leaved trees. The menfolk tend to hang around the store where they drink a lot, talk a lot, and forget their everyday tasks; the women form little groups, silent for the most part, now looking fondly, with soft, black, liquid eyes, at the baby at the breast or asleep in its tiny hammock, now glancing, perhaps with a trace of apprehension, across the narrow strip of space in the full glare of oppressive sunlight, at the menfolk around the store getting louder and drunker, or more often gazing fixedly at the outline of cactus-studded hills in the distance, bathed in the blue-gray haze.

With regard to money prices for goods exchanged, an interesting phenomenon has arisen as a result of the international boundary which runs through the Guajira: the influence of the stronger economy, or at least the stronger currency, that does not respect

frontiers. For many kilometers into the Colombian Guajira all prices are quoted in Venezuelan currency, which is the only medium of exchange. Even a poor herdsman with his goat or sheep to sell, or the housewife with her chickens and eggs, quotes prices in bolivars. Against this type of subtle, intangible economic penetration governments are virtually powerless to act. Boundary *lines* automatically broaden into frontier *zones*. It would be a fascinating study to trace along the various routes from Venezuela into Colombia the depth of the area under the influence of the bolivar. The storekeeper not infrequently makes a huge profit on goods that he buys in Colombian pesos and sells for the same number of bolivars, although the bolivar is worth twice as much as the peso. His percentage of profit under such favorable circumstances is at least 100 percent. Sometimes he charges even more. There seems to be a kind of Guajira wireless system that enables the most distant storekeeper to know the rate of exchange, for the bolivar rate for the peso closely follows the rate of the dollar against the peso in the free market, as quoted in Bogotá.

Since the Spaniards found no gold in the Guajira Peninsula and no large body of industrious agricultural Indians to subject, they largely bypassed it and paid scant attention to its people. Their example has been rather generally followed by the national governments, with the result that a high degree of cultural and political autonomy has been preserved. The Spaniards were responsible, however, for introducing horned cattle and donkeys, sheep, goats, chickens, and hogs. When one realizes that practically everything that today represents wealth for the Guajiro was introduced in the Colonial period, one cannot but wonder what the basis of the pre-Colombian economy was. The Guajiros must have lived on deer and rabbits and shellfish (and the presence of kitchen middens of large extent would support this view) along with primitive agriculture on small plots. Perhaps they carried on a certain amount of trade along the north coast of Colombia and into the Lake Maracaibo Basin. But the carrying capacity of the land of the peninsula *without* the domestic animals that were introduced from the Old World must have been much less than it is at the present time; in other words, the Guajiros must have been many fewer in number than they are today. To be sure, the Dutch Boers in South Africa originally settled as intensive agriculturalists around Capetown and became nomadic herdsmen as they migrated inland, but they had vast acreages of good land available and a large native population to exploit.

Even now, in spite of recent increases, the Guajiros are few in number. (No systematic census has been taken. Estimates vary widely from 80,000 to 130,000, including both sides of the Peninsula.) The Guajiros wrest their living from a harsh and hostile environ-

ment. Most of the basic items of their material culture have been introduced. Yet over the centuries the elements of their nonmaterial culture seem to have suffered almost no change. We must look to cultural factors for an explanation.

Whereas in Western society a patriarchal and patrilinear system prevails, the family consisting of father, mother, and children, with the father acting as head of the household, Guajira society is matrilinear, the family consisting of the mother and her children and the blood relations on the mother's side of the house, the father being but loosely attached to the group, and a maternal uncle serving as head. The husband controls his wife, but not the disposition of her children, except that the bride price of the first daughter belongs to him. Children have relatively few obligations toward their fathers, but they are an integral part of the closely knit, nuclear, and extensive family of their mother, and they take their mother's name. They live the most impressionable years of their lives in a cultural climate that is strictly Guajiro, they become imbued with the culture of their mothers—Guajiro culture. The children of Guajiro mothers, whether their fathers are Indian, Negro, zambo, white, or mestizo—and a considerable amount of intermarriage occurs—for the most part grow up Guajiros. Some Guajiros, mestizos as well as purebloods, that have been educated in Maracaibo or Barranquilla, Caracas or Bogotá, are happy to return to the land of their childhood, put on Guajiro dress, and assume the way of life they lived as children.

Guajiro society has thus been able to absorb new racial strains, and new elements of material culture, such as domestic animals, without the loss of any of the essential characteristics of Guajiro culture. It is not a question of whether "blood will tell," but rather of whether culture will tell, and in the case of the Guajiros we have a textbook example of a societal organization in which the cultural factor has outweighed by far the racial and economic factors. Perhaps without the matrilinear family and the solidarity of that culture-conscious unit no society capable of putting down roots in the refractory Guajiro soil would have evolved, much less survived to achieve a sociohistorical continuum. No such tenacious and long-lived indigenous culture grew up among the Indians on the Paraguaná Peninsula, for instance, or in what is now Falcón.



The Nature of Viruses, Cancer, Genes, and Life—A Declaration of Dependence¹

By WENDELL M. STANLEY

*Professor of Biochemistry and Director of the Virus Laboratory
University of California*

EACH of the four topics mentioned in the title of this lecture is substantial enough to warrant having an entire lecture devoted to it alone. Actually a proper and full discussion of viruses, of cancer, of genes, or of life would require many hours. It may, therefore, appear quite presumptuous to have included all four in the title of a single lecture. But let me hasten to indicate that I do not propose to attempt to develop these topics as such, but that I do propose to sketch in certain basic information and then to devote most of my time to a discussion of new relationships between these four subjects, relationships which I believe to be of the utmost importance.

Recent scientific discoveries, especially in the virus field, are throwing new light on the basic nature of viruses and on the possible nature of cancer, genes, and even life itself. These discoveries are providing evidence for relationships between these four subjects which indicate that one may be dependent upon another to an extent not fully appreciated heretofore, and hence the time is appropriate for a declaration of the nature of the dependence that may be involved. Too often one works and thinks within too narrow a range and hence fails to recognize the significance of certain facts for other areas. Sometimes the important new ideas and subsequent fundamental discoveries come from the borderline areas between two well-established fields of investigation. I trust, therefore, that this declaration of dependence will result in the synthesis of new ideas regarding viruses, cancer, genes, and life, and that these ideas in turn will result in the doing of new experiments which may provide the basis for fundamental discoveries in these fields which are so important to every one of us.

¹ Penrose Memorial Lecture, April 25, 1957. Reprinted by permission from Proceedings of the American Philosophical Society, vol. 101, No. 4, August 1957.

Now I suppose there is no doubt that, of the four topics, life is the one most people would consider to be of the greatest importance. One would think that the nature of life would be easy to define since we are all experiencing it. However, just as life means different things to different people, we find that in reality it is extremely difficult to define just what we mean by life or by a living agent in its most simple form. There is no difficulty in recognizing an agent as living or nonliving so long as we contemplate structures such as man, cats, and dogs, or even small organisms such as the bacteria, or, at the other extreme, structures such as a piece of iron or glass, an atom of hydrogen, or even a molecule of water, sugar, or of our blood pigment, hemoglobin. The former are examples of animate or living agents whereas the latter are examples of inanimate or nonliving things. But what is the true nature of the difference between a man and a piece of iron, or between a bacterial organism and a molecule of hemoglobin? The ability to grow or reproduce and to change or mutate has long been regarded as a special property characteristic of living agents. Certainly mankind and bacteria have the ability to assimilate and metabolize food, respond to external stimuli, and to reproduce their kind—properties not shared by bits of iron or by molecules of hemoglobin. Now if viruses had not been discovered, all would have been well. The organisms of the biologist would have ranged from the largest of animals, whales and elephants and the like, all the way down to the smallest of the bacteria which are about $200\text{ m}\mu$ or a few millionths of an inch in diameter. There would have been a definite break with respect to size since the largest molecules known to the chemist were less than $20\text{ m}\mu$ in size. Life and living agents would have been represented solely by those structures which possessed the ability to reproduce themselves and to change or mutate, and all of these were about $200\text{ m}\mu$ or larger in size, thus more than ten times larger than the largest known molecule. This would have provided a comfortable area of separation or discontinuity between living and nonliving things and would have provided ample justification for considering life as something set distinctly apart and perhaps unapproachable and unexplainable by science.

Then around 1900 came the discovery of the viruses—first the plant virus of tobacco mosaic, then foot-and-mouth disease virus of cattle, and then the first virus affecting man, namely, yellow fever virus. These infectious, disease-producing agents are characterized by their small size, by their ability to grow or reproduce within specific living cells, and by their ability to change or mutate during reproduction. Their inability to grow or reproduce on artificial or nonliving media did not cause too much concern and their reproductive and mutative powers were enough to convince most people that viruses were merely

still smaller ordinary living organisms. However, around 1930 the sizes of different viruses were determined with some precision, and it was found that some viruses were indeed quite small, actually smaller than certain protein molecules. Then in 1935 the first discovered virus, tobacco mosaic, which is a middle-sized virus, was isolated in the form of a crystallizable material which was found to be a nucleoprotein, that is, a substance composed of nucleic acid and protein. This nucleoprotein molecule was found to be $15\text{ m}\mu$ in cross section and $300\text{ m}\mu$ in length and to possess the unusually high molecular weight of about 50 million. It was, therefore, larger than any molecule previously described, yet it was found to possess all the usual properties associated with larger protein molecules. The same material could be obtained from different kinds of mosaic-diseased plants such as tomato, phlox, and spinach plants, whereas plants diseased with different strains of tobacco mosaic virus yielded slightly different nucleoproteins. Many tests indicated that the new high molecular weight nucleoprotein was actually tobacco mosaic virus and it was concluded that this virus could, in fact, be a nucleoprotein molecule. Here, therefore, was a molecule that possessed the ability to reproduce itself and to mutate; hence, the distinction between living and nonliving things which had existed up to that time seemed to be tottering and soon a full-scale intellectual revolution was in progress.

Today the revolution is past and we know that the gap between 20 and $200\text{ m}\mu$ has been filled in completely by the viruses—so much so that there is actually an overlapping with respect to size at both ends. Some larger viruses are larger than certain well-accepted living organisms whereas some small viruses are actually smaller than certain protein molecules. We have, therefore, a continuity with respect to size as we go from the electrons, mesons, atoms, and molecules of the physicist and the chemist, to the organisms of the biologist and on, if you please, to the stars and galaxies. Nowhere is it possible to draw a line in this continuity of structures and say that all above this size are living and all below are nonliving. There appears to be a gradual transition with respect to size and complexity of structure as one goes from things that are normally considered to be alive to things that are generally considered to be nonliving. One is reminded of the quotation attributed to Aristotle over 2,000 years ago to the effect that Nature makes so gradual a transition from the animate to the inanimate that the boundary line between the two is doubtful and perhaps nonexistent. Much scientific knowledge has been accumulated since Aristotle's time but the essence of his statement is as true today as it was when he made it. But does this mean there is really no difference between the animate and the inanimate? I do

not believe that it does. However, we must be willing to define what we mean by life and then we must be willing to accept as living any structure possessing properties fulfilling such a definition.

The essence of life is the ability to reproduce. This is accomplished by the utilization of energy to create order out of disorder, to bring together into a specific predetermined pattern from semiorder or even from chaos all the component parts of that pattern with the perpetuation of that pattern with time. This is life. Now there is another very basic property which seems to be characteristic of living things and that is the ability to mutate, to change or to respond to a stimulus. I do not believe this property is absolutely necessary for life, but it certainly lends grandeur to life, for not only is it responsible for the whole evolutionary process and thus for the myriads of kinds of life we have on earth but, most importantly for mankind, it permits one to dare to aspire. It is presumably responsible for man, his conscience and his faith. It is obvious that I believe that mutation merits much, much study.

The discovery of viruses has permitted us to contemplate the nature of life with a new understanding. It has enabled us to appreciate in a new light the inherent potentialities of chemical structure, whether that of a single molecule or that produced by the interaction of two or more molecules. Viruses were discovered by virtue of their ability to replicate and in the last analysis this ability to reproduce remains today as the only definitive way in which they can be recognized. We may purify and isolate preparations from virus-diseased tissues but it is only when a reasonably pure material is obtained and units of this are found to possess the ability to reproduce themselves that we are privileged to refer to the material as virus. Since the isolation of tobacco mosaic virus in the form of a crystallizable nucleoprotein 15 by 300 $m\mu$ in size, many other viruses have been obtained in pure form and characterized in part by their chemical and physical properties. My colleagues, Arthur Knight, Robley Williams, and Howard Schachman, have made major contributions to the biochemical, electron microscopical, and biophysical knowledge of viruses. Until two years ago all viruses studied had been found to be at least as complex as a nucleoprotein. However, some appear to have lipid, carbohydrate, and in some cases a limiting membrane in addition to nucleic acid and protein. Whereas some viruses, like tobacco mosaic, are crystallizable nucleoproteins which have the usual molecular properties, other viruses, such as vaccinia, have a degree of morphological differentiation which can hardly be called molecular in nature and which is rather more organismal or cell-like in nature. Some of the bacterial viruses have a very complex morphology, with a head and a tail somewhat similar to the sperm of higher organisms.

For a long time many investigators thought that the plant viruses differed basically from viruses affecting animals and man. This idea stemmed mainly from the fact that for 20 years all the crystallizable viruses were plant viruses. This idea had to be relinquished two years ago when my colleagues, Carlton Schwerdt and Frederick Schaffer, obtained poliomyelitis virus, which is a typical animal or human virus, in crystalline form. Since then at least one other animal or human virus has been crystallized and this is crystalline Coxsackie virus obtained by Doctor Mattern of the National Institutes of Health. Hundreds of viruses are known and more are being discovered every month; yet only a dozen or so have been obtained in purified form. In view of the possibility that these may represent the more stable and more readily purified viruses, one cannot be certain that a true picture of the chemical and physical properties of viruses as a whole has been obtained as yet. However, I believe that we have sufficient sampling to be significant for the purposes of the present discussion for we already know that viruses may range from small crystallizable animal, human, or plant viruses which are nucleoprotein molecules, through intermediate structures consisting of nucleoprotein, lipid, and carbohydrate, to large structures possessing a morphology and composition similar to that of accepted cellular organisms. All these diverse structures are bound together by one all-important property, that of being able to reproduce their own characteristic structure when placed within certain living cells. They are all, in short, by definition, alive.

Now I am only too fully aware of objections that some may have to considering a crystallizable nucleoprotein molecule as a living agent. Some may feel that life is a mystery which is and must remain beyond the comprehension of the human mind. With these I must disagree. Some may believe that a living molecule is contrary to religion. Here again I must disagree for I see no conflict whatsoever between science and religion and I see no wrong in accepting a molecule as a living structure. To many scientists the diverse expressions of chemical structure represent miracles, and our expanding knowledge of the wonders of nature provides ample opportunities to express our faith and only serves to make us full of humility. Some may prefer to regard a virus molecule in a crystal in a test tube as a potentially living structure and to restrict the term "living" to a virus during the time that it is actually reproducing. I would have no serious objection to this for I am reminded of the facts that certain tapeworms a foot or so in length can live and reproduce only in certain hosts and that even man himself can be regarded as requiring rather special conditions for life, yet no one objects to accepting man and tapeworms as examples of life. I am also reminded that we are

taught that the essence of a thing is not what it is, but what it does, and the doing of something involves time; hence there may be good reason always to consider the virus with time. Regardless of certain mental restrictions that may differ from person to person, I think there is no escape from the acceptance ultimately of viruses, including the crystallizable viral nucleoprotein molecules, as living agents. This must be done because of their ability to reproduce or to bring about their own replication. Certainly the essence of life is the ability to reproduce, to create a specific order out of disorder by the repetitive formation with time of a specific predetermined pattern and this the viral nucleoprotein molecules can do.

Of course, it would have been dull indeed if the first formed living agent had been restricted to exact duplicates of itself. The logical reasoning provided in schemes such as those outlined by Calvin, Haldane, Horowitz, Oparin, and Urey by means of which relatively complex organic substances could have arisen from inorganic matter provides justification for assuming that a chemical structure, perhaps something like nucleic acid, which possessed the ability to replicate, did come into being once upon a time. It need to have happened only once, and thereafter without the great phenomenon of mutation it merely would have kept going until it had filled the world with replicates of this precise structure or until it had exhausted the starting materials. However, Nature has provided a built-in error so that the replication process is not perfect and about one in every million or so replicates is slightly different. This change, which has been of tremendous fundamental importance, we now recognize as mutation, and as these errors or differences were accumulated by replicating structures it became necessary to make formal recognition of them. These differences or markers we now call genes. We do not recognize genes directly but only by differences. Needless to say, some physical structure had to be responsible for the accumulation, preservation, and potential exhibition of these differences and this assembly of genes we call a chromosome. The incorporation of one or more assemblies of genes into a structure possessing a limiting membrane, which we now call a cell, then made possible gene interchanges between these cellular assemblies. This genetic interchange by the fusion of two cells, a sexual process, also represents a phenomenon of the greatest fundamental importance for this permitted genetic recombination, a factor that has served to speed up the evolutionary process immeasurably. Therefore, life as we know it today is dependent not only upon reproduction but also upon mutation and genetic recombination.

Now let us consider for a moment the relationships between genes and viruses since we see that both are related to life. Muller's esti-

mate of the maximum size of a gene would place it just below tobacco mosaic virus, near the middle of the viruses. Both genes and viruses seem to be nucleoproteins and both reproduce only within specific living cells. Both possess the ability to mutate. Although viruses generally reproduce many times within a given cell, some situations are known in which they appear to reproduce only once with each cell division. Genes usually reproduce once with each cell division, but here also the rate can be changed, as, for example, in the case of polyploidy resulting from treatment with colchicine. Actually the similarities between genes and viruses are so remarkable that viruses very early were referred to as "naked genes" or "genes on the loose." Two great discoveries, one which began in 1928 and the other which occurred in 1952, have provided experimental evidence for an exceedingly intimate relationship between viruses and genes. In 1928 Griffith found that he could transform one specific S type of pneumococcus into another specific S type by injecting mice with non-virulent R forms together with large amounts of heat-killed S pneumococci of a type other than that of the organisms from which the R cells were derived. Living virulent S organisms of the same type as the heat-killed S forms were then recovered from the animals. Later Dawson and Sia as well as Alloway found that the addition of an extract of one type of capsulated pneumococcus to a culture of a noncapsulated rough form would convert the latter into the same type of capsulated pneumococcus which provided the extract. It was obvious that something was being transferred and in 1938 I discussed the possibility that this "something" might be a virus. In 1944 Avery and his colleagues at the Rockefeller Institute proved that this something was a transforming principle consisting of deoxyribonucleic acid (DNA). Muller in 1947 discussed the possibility that the DNA might correspond to still viable parts of bacterial chromosomes loose in solution which, after entering the capsuleless bacteria, undergo a kind of crossing over with the chromosomes of the host, but this suggestion was not widely accepted. That the phenomenon was not an isolated one was demonstrated in 1953 by Leidy and Alexander who obtained similar results with an influenza bacteria system. The close relationship to genetics was further emphasized by work of Hotchkiss and by Ephrussi-Taylor who, as well as Leidy and Alexander, showed that drug resistance and other genetic factors could be so transferred. This work provided evidence that genetic factors or genes, if one prefers such a designation, can be represented by DNA and can be obtained in chemically pure solution.

This information, as well as our knowledge of viruses, was soon fortified by the very important discovery by Zinder and Lederberg in 1952 of transduction in *Salmonella* by means of a bacterial virus.

It was found that genetic factors could be carried from one type of *Salmonella* cells to another type by means of a bacterial virus. In this type of transformation the genetic fragment is not free but is carried within the structure of the bacterial virus. It is, for example, not affected by the enzyme deoxyribonuclease, and in this respect is unlike the DNA pneumococcus transforming principle. However, it is not necessary for the virus actually to possess virus activity, for killing of the virus by ultraviolet light does not prevent the transduction of other traits. The closeness of the relationship between the virus and the genes of the host is emphasized by the fact that the transducing ability of any bacterial virus is determined strictly by the character of the cells on which the virus was most recently grown. Virus grown on Serotype E₂ *Salmonella* cells will, when added to Serotype E₁ cells, convert a fraction of these cells into Serotype E₂ cells. It is of interest to note that the virus in filtrates of toxin-forming bacterial strains will convert nontoxin-forming cells into toxin-forming cells. In transduction, a fragment of a chromosome which might be regarded as a gene or a collection of a few or even many genes can be transferred from one kind of donor cell to another kind of receiver cell and be incorporated into the genetic apparatus of the receiver cell. In the pneumococcus or influenza bacterium this can be caused by a DNA preparation which can be separated and isolated as such and in *Salmonella* this gene or gene collection rides within the bacterial virus, presumably with the viral DNA, which is added to the cell to be transduced. Here one hardly knows what to call a virus and what to call a gene for it is obvious that at times the two merge completely.

The persistence of a bacterial virus in an apparently concealed form of prophage in lysogenic strains of bacteria, extensively investigated by Lwoff, provides further evidence in this direction. Lysogenic bacteria perpetuate in what may be considered a hereditary manner the property of being able to produce a bacterial virus. The term "prophage" is used to describe the form in which the potentiality to produce a bacterial virus is perpetuated in lysogenic bacteria. Prophage is nonpathogenic and noninfectious in the usual sense, but, since it is multiplied at least once with each cell division, it may be regarded as infectious in the sense that genes or chromosomes are infectious. In other words, the prophage might be considered as a temporary part of the genetic apparatus of the cell, the genetic element that differentiates a lysogenic from a sensitive cell, and at the same time as the noninfectious form of a bacterial virus. There are times, therefore, when a virus may not exhibit its normally infectious nature but have its potentially unlimited reproductive capacity under genetic control so that it replicates only once with each cell division. There

are times when a specific genetic element of a cell can be freed of the normal controlling mechanism of the cell and go forth in viable form in solution or associated with a virus, enter a different cell, replace a homologous chromosomal segment, and resume its original specific function in the new cell. It is obvious that the latter phenomenon could readily be considered an infectious process, and that viruses can act as genes and genes as viruses under certain circumstances.

I should now like to discuss the relationships which involve cancer. You probably know that cancer or abnormal, uncontrolled cellular growth may occur in all kinds of organisms and that cancer is second only to heart disease as a killer of mankind; hence I need say no more about the relationship between cancer and life. Cancer originates when a normal cell for reasons, some known and some unknown, suddenly becomes a cancer cell which then multiplies widely and without apparent restraint. Cancer may originate in many different kinds of cells, but the cancer cell usually continues to carry certain traits of the cell of origin. The transformation of a normal cell into a cancer cell may have more than one kind of a cause, but there is good reason to consider the relationships that exist between viruses and cancer. Viruses have been implicated in animal cancers ever since Peyton Rous, in 1911, transmitted a chicken sarcoma from animal to animal by means of a cell-free filtrate. Despite the fact that today viruses are known to cause cancer or tumors in chickens, pheasants, ducks, mice, frogs, rabbits, deer, and other animals, and even in certain plants, there exists a great reluctance to accept viruses as being of etiological importance in human cancer. However, basic biological phenomena generally do not differ strikingly as one goes from one species to another, and I must say that I regard the fact, now proved beyond contention, that viruses can cause cancer in animals to be directly pertinent to the human cancer problem. It should be recognized that cancer is a biological problem and not a problem that is unique for man.

Since there is no evidence that human cancer as generally experienced is infectious, many persons believe that because viruses are infectious agents they cannot possibly be of etiological importance in human cancer. However, this is not a valid conclusion for several reasons. It is well known from the work of Bryan and of Beard that animal cancer viruses may alternately be filterable and hence infectious and then nonfilterable and hence appear noninfectious, apparently owing to great variations in the actual amount of virus present in the cancer. It is also well known that viruses may be highly specific, so specific in fact that a given virus may infect and cause disease only in one kind of cell in one kind of animal and hence, under all other conditions, appear noninfectious. For example, the kidney

carcinoma virus of the leopard frog studied by Lucké would appear to be such a virus. Then there is the possibility that many may be carrying viruses of etiological importance for cancer which for one reason or another have not yet been discovered. The possibility of mutation of latent viruses into a new strain of etiological importance must also be kept in mind. Pertinent to both of these possibilities is the discovery during the past few years of dozens upon dozens of hitherto unknown viruses in human beings. These consist of the ECHO viruses isolated from the human intestinal tract, the adenoviruses isolated from the upper respiratory tract and eyes of man, and a group of viruses isolated from human sera. New viruses of man are discovered almost every week. Thus we now have many more human viruses than we know what to do with and there is no reason to shy away from giving consideration to viruses as causative agents in human cancer for lack of the viruses.

During the past few years there has been an almost unbelievably rapid development of techniques by means of which it is now possible to grow almost all kinds of human and animal cells in the test tube and, as a consequence, vast new opportunities for experimentation on human cells without danger to man have opened to us. These cells are also providing a means for the isolation of new viruses, since many kinds of cells are very susceptible to many viruses. The human amnion cell, which my colleagues Elsa Zitcer, Jørgen Fogh, and Thelma Dunnebacke first obtained from the full-term amnion in cell culture, is proving of great use in this connection as well as in studies on the transition from a normal to a potentially malignant cell. For example, we are finding interesting changes in chromosome number and in ability to grow in cortisone or X-ray treated animals as these human amnion cells are passed in culture. It is also of interest that one of the adenoviruses has been found to destroy human cancer cells both in the human being and in the test tube. Thus a virus may cause a cancer and a virus may destroy a cancer. Unfortunately in the case of Huebner's studies on carcinoma of the human cervix not all of the cancer cells were destroyed and the cancer eventually progressed. However, Huebner, as well as others, is attempting to train a series of viruses to grow on cancer cells, so this approach may not be too hopeless. In the same way it is possible to train cells to respond to viruses and this may provide even better test systems for human viruses as yet undiscovered. Even if eventually one should find no cancer virus among the large number of human viruses, the fact that man carries so many viruses within his cells and that these are continually passing from person to person means that we should be ever alert to the possibility of transduction by these viruses. Of course, there is no confirmed case of transduction in higher organisms as yet.

However, human cancer is a fact and there is certainly something within every human cancer cell that insures its reproduction whether we call it a gene or a chromosomal fragment, and so long as human viruses are so abundant we certainly have the possibility of transduction.

There are many examples of latent viruses that may remain hidden for a lifetime or even for generations only to come to light as a result of some treatment or change. Most human beings acquire the virus of herpes simplex quite early in life and in many persons the evidence for the persistence of this virus throughout their lifetime is quite good. Traub has found that infection of a mouse colony with the virus of lymphocytic choriomeningitis can result, with time, in an inapparent infection of all animals. The virus is apparently transmitted *in utero* and remains with the animal throughout its life; hence this virus persists throughout generation after generation of mice. Injection of such mice with sterile broth can revive the pathogenicity of the virus and bring it into light. Certain potato viruses such as potato X virus, also known as the healthy potato virus or the latent mosaic of potato virus, can be passed from generation to generation without causing an apparent disease. This virus is not present in several varieties of potato grown in Europe, but it is thought to be present in all, or almost all, potato plants grown in the United States. Needless to say, it was only by virtue of the fact that potato plants without this virus are known to exist and the fact that this virus causes obvious disease symptoms when inoculated to certain other plants that it was possible to establish the actual existence of this virus. In the absence of this information this latent mosaic virus would have to be regarded as a normal constituent of the potato plant.

Since viruses can mutate and examples are known in which a virus that never kills its host can mutate to form a new strain of virus that always kills its host, it does not seem unreasonable to assume that an innocuous latent virus might mutate to form a strain that causes cancer. The great wealth of newly discovered viruses of man plus our knowledge of the latent virus phenomenon provides ample justification to reexamine quite carefully the relationships between viruses and human cancer.

Another fact which may prove of the greatest importance in this connection is that treatment of certain lysogenic strains of bacteria with physical and chemical agents, such as X-rays, ultraviolet light, nitrogen mustard, certain chemical-reducing agents or iron-chelating agents, results, after a latent period, in the lysis of the bacterial cells and the release of large amounts of bacterial virus particles. These agents are called "inducers" and you may recognize some as carcinogenic agents for man and animals. Nonlysogenic bacteria are un-

affected by these "inducers" in so far as the production of a bacterial virus is concerned. Is it possible that this activation of a prophage by certain chemical or physical agents with development into a fully infectious bacterial virus and the consequent destruction of the bacterial cells provides a biological example of a process which occurs in man? I believe that this activation of prophage as well as the phenomenon of transduction by free deoxyribonucleic acid in the pneumococcus and by bacterial viruses in *Salmonella* is pertinent to the human cancer problem, especially so in view of the recent discovery of dozens upon dozens of new viruses of man. Certainly the experimental evidence now available is consistent with the idea that viruses, as we know them today, could be the etiological agents of most, if not all cancer, including cancer in man. I have been urging the acceptance of this idea as a working hypothesis because it will result in the doing of experiments that might otherwise be left undone, experiments that could result in the solving of the cancer problem. Needless to say, what we do in the way of experimentation depends in large measure upon what we think and I am sure the time has come when we should change our thinking with respect to the nature of cancer.

I hope that by this time it is obvious that viruses, cancer, genes, and life are tied together by a whole series of relationships, that viruses can act as genes and genes as viruses under certain circumstances, that viruses can cause cancer and that viruses are structures at the twilight zone of life partaking both of living and of molecular properties. Let us now see whether there is a common thread of understanding permeating all these relationships. We know that viruses have been thought to be at least as complex as a nucleoprotein, but we also know that the transforming agent of the pneumococcus has been found to be a deoxyribonucleic acid and there is presumptive evidence that the genetic stuff of the bacterial viruses is also deoxyribonucleic acid. However, until recently no gene or chromosome or any of the ordinary viruses had been isolated as such in the form of nucleic acid; hence the "stuff of life," as well as the viruses, has been considered to be nucleoprotein in nature with considerable doubt as to whether the protein or the nucleic acid or the combination of the two was really the biologically active structure.

A recent very important discovery made in our laboratory by Doctor Fraenkel-Conrat has changed the situation considerably and now makes it seem certain that nucleic acid is the all-important structure. It was reported by Fraenkel-Conrat and also shortly thereafter by Gierer and Schramm in Germany that special treatment of tobacco mosaic virus yielded a nucleic acid preparation possessing virus activity. It would now appear necessary to recognize that a nucleic acid structure of around 300,000 molecular weight can

possess, coded within its 1,000 or so nucleotides, not only all the information that is necessary to bring about in the host cell the production of more of this same nucleic acid, but also apparently the *de novo* synthesis of its own characteristic and highly specific protein with which it eventually coats itself. This work provides wonderful evidence for a direct relationship between specific nucleic acid and specific protein synthesis and makes it possible to consider virus and gene action, including their relationships to cancer and to the nature of life, in terms, not of nucleoprotein structure, but of nucleic acid structure. We see, most importantly, that viruses, cancer, genes, and life are all directly dependent upon the structure of nucleic acid.

It may be calculated that a thousand-unit polynucleotide linear chain consisting of a coded repeat of only four different components, adenine, guanine, cytosine, and uracil, in the same ratio as exists in tobacco mosaic virus nucleic acid, could form about 10^{500} different arrangements. This number is so large that it is incomprehensible. Even a hundred-unit polynucleotide chain of this composition could exist in about 10^{57} different arrangements and this number is vastly larger than the total of all living things on earth and in the oceans. We have, therefore, in this structure consisting of the four chemicals, adenine, guanine, cytosine, and uracil (thymine in the case of deoxyribonucleic acid), repeated many times over in unique fashion, the code for every bit of life on earth and in the sea. When a normal cell becomes a cancer cell there is undoubtedly a change in this structure within the cell. It is of interest to note that many anti-cancer compounds are antimetabolites for these chemical components of nucleic acids. And in our laboratory Litman and Pardee made the very important observation that the incorporation of 5-bromouracil into a bacterial virus in place of thymine resulted in the production of the highest percentage of mutants ever recorded. Certainly all this information plus the discovery that virus activity can be a property of nucleic acid and our knowledge of relationships between viruses, cancer, genes, and life now make it obvious that the common thread upon which all of these depend is specific nucleic acid structure. Therefore, this declaration of dependence revolves around nucleic acid.

I believe that the elucidation of the structure of nucleic acid in all its aspects is the most important scientific problem we face today. It is vastly more important than any of the problems associated with the structure of the atom, for in nucleic acid structure we are dealing with life itself and with a unique approach for bettering the lot of mankind on earth. It is possible that the solution of this scientific problem could lead eventually to the solution of major political and economic problems. Never before has it been possible to realize so fully our utter dependence upon the structure of nucleic acid.

Eventually chemists should be able to synthesize a small polynucleotide specifically arranged; hence one may now dare to think of synthesizing in the laboratory a structure possessing genetic continuity and of all the tremendous implications of such an accomplishment.

SELECTED REFERENCES

AVERY, O. T.; MACLEOD, C. M.; and McCARTY, M.

1944. Studies on the chemical nature of the substance inducing transformation of pneumococcal types. Induction of transformation by a deoxyribonucleic acid fraction isolated from pneumococcus type III. *Journ. Exp. Med.*, vol. 79, pp. 137-158.

CALVIN, MELVIN.

1956. Chemical evolution and the origin of life. *Amer. Sci.*, vol. 44, pp. 248-263.

FILDES, SIR PAUL, and VAN HEYNINGEN, W. E. (EDITORS).

1953. The nature of virus multiplication. Cambridge University Press.

FRAENKEL-CONRAT, H.

1956. The role of the nucleic acid in the reconstitution of active tobacco mosaic virus. *Journ. Amer. Chem. Soc.*, vol. 78, p. 882.

FRAENKEL-CONRAT, H., and WILLIAMS, ROBLEY, C.

1955. Reconstitution of active tobacco mosaic virus from its inactive protein and nucleic acid components. *Proc. Nat. Acad. Sci.*, vol. 41, pp. 690-698.

GIERER, ALFRED, and SCHRAMM, GERHARD.

1956. Die Infektiosität der Nucleinsäure aus Tabakmosaikvirus. *Zeitschr. Naturforsch.*, Bd. 11b, pp. 138-142.

GRIFFITH, F.

1928. The significance of pneumococcal types. *Journ. Hyg.*, vol. 27, p. 113.

LEDERBERG, JOSHUA.

1956. Genetic transduction. *Amer. Sci.*, vol. 44, pp. 264-280.

OPARIN, A. I.

1938. The origin of life. Trans. by S. Margulis. New York.

RIVERS; THOMAS M.

1941. The infinitely small in biology. *Science*, vol. 93, pp. 143-145.

ROUS, P.

1946. Concerning the cancer problem. *Amer. Sci.*, vol. 34, pp. 329-358.

SCHAFFER, F. L., and SCHWERDT, C. E.

1955. Crystallization of purified MEF-1 poliomyelitis virus particles. *Proc. Nat. Acad. Sci.*, vol. 41, pp. 1020-1023.

STANLEY, W. M.

1939. The architecture of viruses. *Physiol. Rev.*, vol. 19, pp. 524-556.

1941. Some chemical, medical and philosophical aspects of viruses. *Science*, vol. 93, pp. 145-151.

1949. The isolation and properties of crystalline tobacco mosaic virus. *Les Prix Nobel en 1947*. Stockholm.

ZINDER, N. D., and LEDERBERG, J.

1952. Genetic exchange in Salmonella. *Journ. Bact.*, vol. 64, p. 679.

ZITZER, ELSA M.; FOGH, JØRGEN; and DUNNEBACKE, THELMA H.

1955. Human amnion cells for large-scale production of polio virus. *Science*, vol. 122, p. 30.

Mystery of the Red Tide¹

By F. G. WALTON SMITH

*Vice President, The International Oceanographic Foundation
Coral Gables, Fla.*

[With four plates]

ONE of the commonest and yet most baffling problems of marine science underlies the red tide which has killed millions of fishes off the west coast of Florida in past years. Temporarily, it caused physicians' offices to be swamped with patients suffering from the accompanying windborne irritant gas. Mounds of dead fish covered the beaches for miles and had to be bulldozed and buried in order to remove their stench. The effect on the tourist industry alone was serious enough to awaken both State and Federal governments to its economic importance and eventually to set teams of scientists to work in a concentrated effort to solve the problem. What caused the sea to change color, fish to die, and visitors to develop sore throats? Marine biologists and oceanographers are following up all possible clues in an attempt to unravel the mystery and to control its devastating effects.

MANY COLORS

From the earliest days man has viewed with surprise and, at times, with awe the sudden appearance of a vivid discoloration in the natural waters of lakes and the sea.

Nearly always the cause turns out to be a rapid growth or "bloom" of microscopic water life, normally present in comparatively small numbers, but under certain circumstances growing and reproducing at an excessive rate until it is presently in very heavy concentrations—sufficient to affect the color, feel, taste, and smell of the water and sometimes, though not always, to render it poisonous to the fish inhabiting it.

A WORLD-WIDE PLAGUE

In the early fall, along the western coast of Japan, patches of water frequently become brown in color and oily in appearance, owing to

¹ Reprinted by permission from *Sea Frontiers, Bulletin of the International Oceanographic Foundation*, vol. 3, No. 1, March 1957. Unless otherwise credited, photographs by courtesy of *Sea Frontiers*.

the blooming of one of the diatoms, a form of microscopic plant life of the sea known as *Rhizosolenia*. The abundance of another microscopic plant, the alga *Trichodesmium*, is responsible for the color which gives its name to the Red Sea, and to the Vermillion Sea in the Gulf of California. Blue-green algae in the Baltic Sea and Sea of Azov are often so numerous that the sea surface has been compared in color to a green meadow. In other places and times bacteria cause the Sicilian "Lake of Blood," and some of the shallow European seas, too, become discolored.

The most striking of all these plankton blooms are the red waters, known as red tides. Some were reported off the coast of Chile as long ago as 1832 by Charles Darwin on the voyage of HMS *Beagle*, and from such widely scattered places as British Columbia, the Gulf of Mexico, South Africa, Japan, and Australia.

Not all red tides are accompanied by the death of fishes, nor are they all caused by the same organism. During the past year a red tide off the coast of Chile was investigated by an expedition of the University of Miami and found to be due to a bloom of a diatom called *Prorocentrum micans*. In other places bacteria, algae, and another microscopic form of sea life, dinoflagellates, have been found responsible. In some cases jellyfishes and small crustaceans such as copepods and euphausiids, the krill or food of whales, have caused the discoloration.

CAUGHT BY SURPRISE

Few people in Florida, other than fishermen, had ever heard of red tides before the latter part of 1946, when the poisonous red water began its disastrous work. Nevertheless, the records show that the discoloration of water and death of fishes were seen off the coast of Florida as early as 1844 and on several occasions since then. But the west coast of Florida was not then the popular area for anglers, tourists, and those who wish to retire in the sun.

In November 1946 patches of brownish water containing dead or dying fishes were seen by fishermen about 14 miles off the coast of Naples. The pestilence began to spread northward, and during the following three or four months it appeared at Sanibel and Captiva Islands just off the coast. From Cape Romano in the south to Englewood Beach in the north dead fishes were found floating in the water. Huge quantities of the dead carcasses were washed ashore, in places as much as 100 pounds to the front foot. Dr. Gordon Gunter and fellow scientists from Miami found dead turtles, shrimps, crabs, and oysters as well as an impressive list of the various species of commercial and noncommercial fishes before the first series of outbreaks died down in March 1947.

NEW OUTBREAKS AND EMPTY HOTELS

The scourge reappeared later as far north as St. Petersburg and by the time it finally died out in August 1947, more fish had been killed than in the earlier outbreak.

Faced with a disastrous repetition of beaches littered with dying fish, residents and visitors complaining of irritant gases, and the hotels, motels, and beach resorts changing in a few weeks from prosperous enterprises to almost deserted buildings, there was a great public outcry for action. But the inflexible system of legislation and government makes it almost impossible to authorize the moving in of a team of qualified scientists at a moment's notice or even to provide the funds for doing so.

Fortunately, however, J. N. Darling, a winter resident of Captiva Island and a well-known naturalist, was present at the first outbreak. He not only made his own observations but also with his own funds helped defray the expenses of biologists who set out to investigate the problem during January 1947.

THE COUNTERATTACK BEGINS

The appearance of the water immediately suggested the presence of plankton bloom. By examining samples under a microscope it was soon found that a prodigious growth of microscopic organisms had indeed taken place and that one in particular seemed to be more characteristic than others. The credit for first noticing this goes, however, to Mr. Darling, whose curiosity had been aroused by strange little moving blobs of protoplasm which he noticed under a borrowed microscope. Miami scientists recognized this as a type of organism already notorious as a killer of fish when present in plankton blooms. This kind of microscopic sea life passes under the cumbersome general name of "dinoflagellates."

One of the dinoflagellates, *Gonyaulax catenella*, was found to be the cause of mussel poisoning along the coast of California during the summer months. Large numbers of this organism in the plankton, when taken in as food by mussels, rendered these shellfish dangerous for human consumption. Others have been found in poison water elsewhere. One in particular bears the general name of *Gymnodinium*, and it was this kind which the marine biologists found in Florida red tide. During the investigations as many as 60,000,000 individual cells to the pint of water were found in the affected waters.

MEET "JIM BREVIS"

Examination of the *Gymnodinium* present in the Florida outbreaks showed that it is a 4-lobed blob of almost naked protoplasm, with a whiplike flagellum trailing from one end. Although practically

transparent, the organism carries oval-shaped objects which give it color. It secretes a slimy substance from its surface in huge concentrations and this in turn gives the water the consistency of thin syrup.

The first step was to determine exactly which species of *Gymnodinium* was causing the damage. Careful study disclosed it to be different from any previously known to science. Accordingly, Dr. Charles Davis, of the Miami staff, wrote a careful description and officially

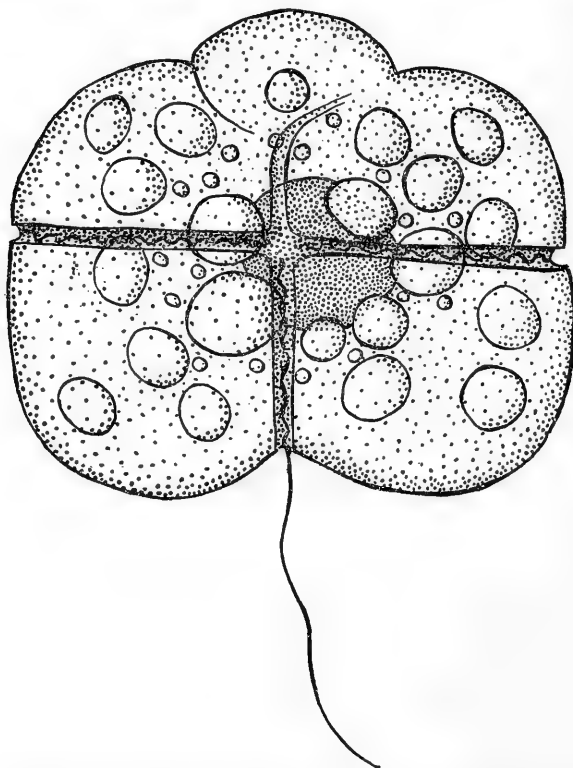
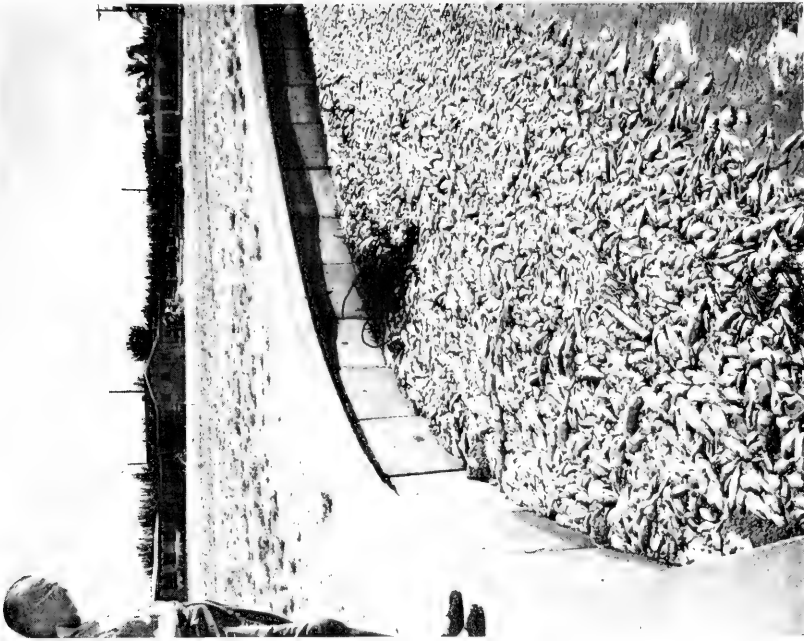

FIGURE 1.—The cause of the red tide, *Gymnodinium brevis*, magnified 3,000 times. First found in the 1947 outbreak. (Diagram courtesy of Sea Frontiers.)

named it a new species, *Gymnodinium brevis*. It was not long before the press and the general public nicknamed it "Jim Brevis." It is still known by this to the residents of Florida's west coast.

GAS WARFARE OR FOREIGN AGENTS?

While this was happening there were many other theories advanced, both by the general public and by armchair scientists. Some said that nonpoisonous plankton clogged the gills of fishes and asphyxiated them. Others held that wartime poison gases had been dumped into the ocean and that the release of these was responsible both for dead



2. Heavy concentration in one of the inlets near St. Petersburg, Fla., during the red tide attack off the coast in October 1957. (Photograph courtesy of St. Petersburg *Times*.)



1. Windrows of dead fish at low tide, casualties of the red tide attack of September-October 1957, along the Gulf of Mexico at Johns Pass, north of St. Petersburg Beach.

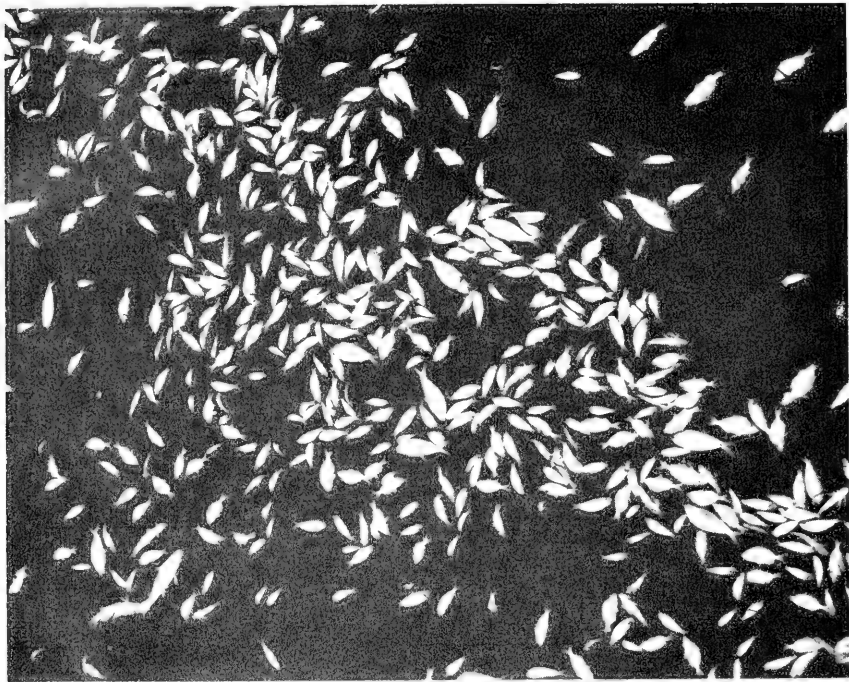

1. Dead fish, killed by the red tide, drifting in through the inlet near St. Petersburg, Fla., October 1957. (Photograph courtesy of St. Petersburg *Times*.)

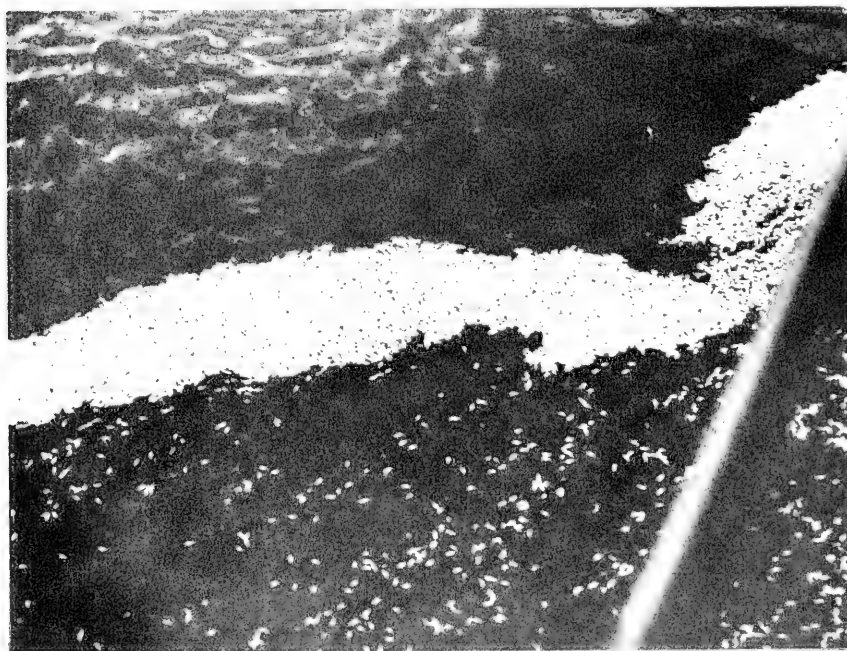

2. Heavy accumulations of dead fish marking the edge of oily red water near Tampa Bay (Photograph courtesy of Ecological Monographs and Associated Press.)



1. Beaches littered with dead fish, a common sight and smell during red tide outbreaks.



2. Cleanup equipment used at City of St. Petersburg Beach. Blade piles decaying fish and seaweed, and pitchforks are used to load beach debris into trailers. (Photograph courtesy of St. Petersburg *Times*.)

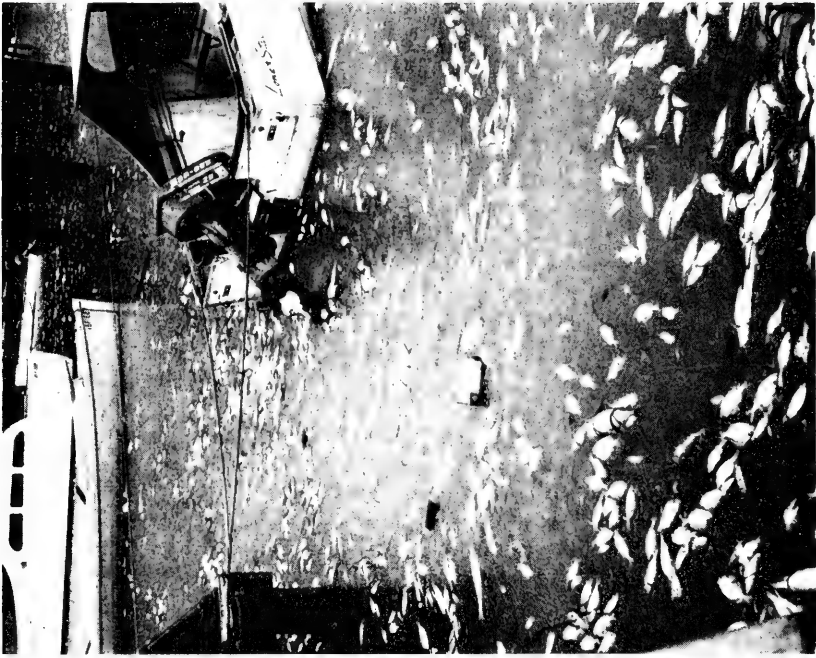

2. Fish killed by the red tide during the attack of October 1957 drifting among anchored boats at Johns Pass, Fla., north of St. Petersburg. Note fish stranded on outboard motor. (Photograph courtesy of St. Petersburg Times.)

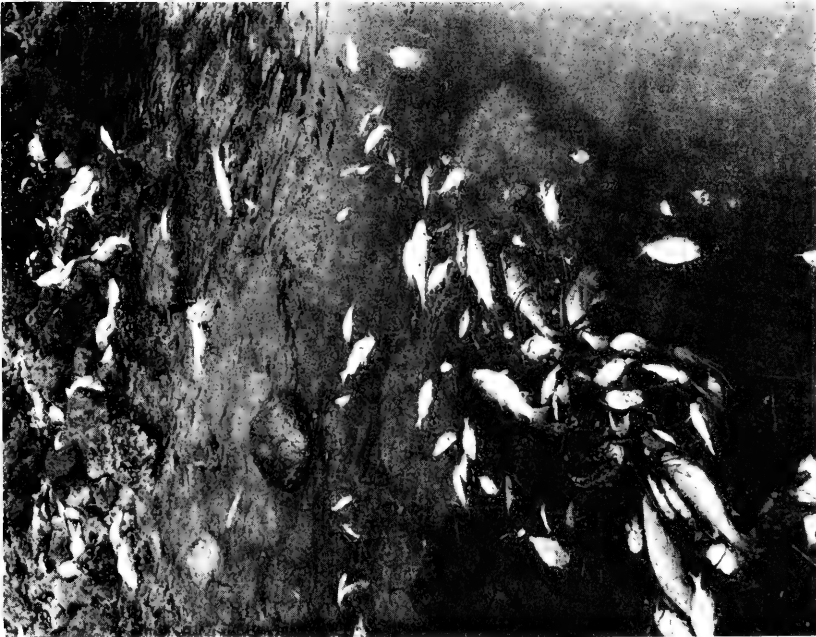

1. Closeup of dead fish at Johns Pass. These fish were killed by the red tide in the Gulf of Mexico, offshore, during the September-October 1957 attack, and were carried by tidal currents into rocky cove north of St. Petersburg Beach.

fish and the sore throats, quite forgetting that red tide, dead fish, and sore throats had appeared off the Florida coast long before any war gas was available for dumping. Some theories were even more fantastic, involving the deadly and secret activities of foreign agents.

But the investigators by now were satisfied as to the immediate cause of the trouble. Small fishes were placed in samples of water containing "Jim Brevis." The fishes died in less than 24 hours. In similar tanks of water with no "Jim Brevis" the fishes lived. Samples of sea water from a red-tide outbreak were heated nearly to boiling point and the vapor given off was found to cause coughing and sneezing.

Unfavorable publicity in the wake of the red-tide troubles led to a vigorous effort to combat them, and the scientists from Miami who conducted the original investigation were now reinforced by investigators from the United States Fish and Wildlife Service and the Woods Hole Oceanographic Institution. Dr. Paul S. Galtsoff confirmed the original findings of the poisonous nature of "Jim Brevis" by carefully conducted tests. Irritant gas, first earlier obtained by boiling red-tide water, was traced by Alfred Woodcock to small particles of water thrown into the air by breaking waves, and remaining in suspension for a considerable time. In this way the red-tide poison became airborne. Injection of a small amount of red-tide water by spray into the nose caused the familiar sneezing and sore throat, thus confirming Woodcock's theory.

THE CAUSE OF A CAUSE

The direct cause of red tide and its attendant evils was clear enough. The recognition of "Jim Brevis" did not help very greatly in preventing it though. It is true that copper sulfate and other chemicals have long been known as potential killers of plankton blooms if sprayed on the sea, but, by the time a red-tide outbreak is noticed, the fishes are dead and drifting onto the beaches and the tourists and residents are coughing and sneezing. It is then too late. Like an explosion, the red tide must be stopped before it breaks out. It is necessary to predict the time and place of an outbreak. The \$64 question was what are the events or causes which *antedate* the sudden catastrophic blooming of "Jim Brevis"?

An obvious thing to look for is the source of food to support the rapid growth of plankton characteristic of plankton blooms. In Florida there seemed to be a ready answer in the existence of phosphate mining operations. Land plants need fertilizer—phosphorus, nitrogen, potassium—for food, and also certain other substances in very small quantities to promote and sustain growth. This is equally true even of small plantlike cells in the sea, including "Jim Brevis." Moreover it frequently happens that the phosphorus compounds are

the least plentiful, so that any sudden increase in their quantity in the sea may lead to a great growth of plankton.

RAINFALL AND RED TIDE

The Miami scientists, together with others from the University of Florida and the U. S. Fish and Wildlife Service, followed up these speculations. The probability in mind was that excessive rainfall of an equivalent type of mechanism might wash down into the sea unusual quantities of phosphorus dissolved out of the phosphate rocks inland, or from the mining refuse by way of rivers. Unfortunately the final analysis seemed to show that even in years of no red tide there is sufficient phosphorus in west coast Florida waters to support a red-tide outbreak. Why then is red tide not *always* present? A possible clue comes from a study of rainfall and river discharge. There seemed to be some connection between red-tide outbreaks and a higher than average river discharge. But red tide had not developed in all of the past years when rainfall or river discharge was high. So something else must be involved.

There were indications that in the shallow creeks and bays, separated from Gulf of Mexico waters by a chain of islands, materials important to the growth of "Jim Brevis" occurred and that the mixture of this water with the sea water outside might provide exactly the right conditions for red-tide development.

RESEARCH ALMOST ABANDONED

Careful detective work was almost brought to a stop at this stage. Since 1947 red tide seemed to have disappeared and there was no way of telling whether it might return in 1 year or 10 years. Consequently public interest disappeared and with it also the funds necessary to continue research. The problem now facing the scientist was not red tide, but the difficulty of being able to continue investigations without interruption. It is unhappily true that legislatures and governments, being in the public service and sensitive to public opinion, are apt to finance research only when an emergency such as the red tide actually occurs, at which time, paradoxically, the necessary delays in legislative machinery render it too late to be of service. As soon as the emergency is over, all the painstaking groundwork which could lead to the final answer is likely to be discarded.

NEW OUTBREAKS REOPEN RESEARCH

Although marine biologists from Miami were unable to follow up their earlier discoveries in full measure and although the Fish and Wildlife Service Laboratory at Sarasota was closed, scientific interest continued since it was to be expected that at some undetermined

future time the plague of dead fish would return and with it a public clamor for a solution.

These expectations were partly realized in 1952 when a fresh but minor outbreak occurred. About the middle of September 1953 further red tide was reported and this continued at intervals throughout the winter and in the spring and summer of 1954. The new alarms brought special funds to aid research at Miami and increased federal activity. The State of Florida made a wise move by setting up a Red-Tide Committee in order to coordinate research activities. This might also serve to keep legislature advised of the need for continuing research between red-tide years.

RED TIDE IN TEST TUBES

Materials are needed for the growth of "Jim Brevis" and the suspicion that the brackish bay waters contained some essential part of these materials received new attention as the result of work carried out by the Haskins Laboratory in New York. For the first time the red-tide type of organism was kept alive in the laboratory in a pure culture, uncontaminated by bacteria or other organisms. The Fish and Wildlife Service followed this up and is now seeking more detailed information about the food requirements and behavior of "Jim Brevis" in the laboratory.

Part of this is being done at Galveston, Tex., part in Florida in a laboratory in Naples where a converted cabin cruiser is stationed. Many of the questions of the likes and dislikes of "Jim Brevis" may thus be answered by the Service, which now has a team of 20 people engaged in the investigation. Not only is "Jim Brevis" being kept alive for studies of his daily needs, but experiments are being conducted to determine the best way of killing him.

PREDICTIONS AND PATTERNS

As the Fish and Wildlife Service attacks one side of the problem, a four-man team from Miami advanced from another direction. In order to kill "Jim Brevis" and to prevent the red tide spreading, even if a suitable poison were available, it would still be necessary to know in advance when and where an outbreak was likely to take place and how it was likely to spread.

Red tide first appears as a patch of discolored water, with dead and dying fishes, particularly along its edge. Within a few days the enormous concentration of microscopic dinoflagellates brings about their own death by overcrowding, the red color vanishes, and after the dead fish have been drifted ashore, all the typical signs begin to disappear. Several days or even weeks later, however, a similar outbreak may take place at another part of the coast. In a typical red-

tide year a succession of such outbreaks at different parts of the coast may occur with varying intervals of time.

What was the connection between successive outbreaks? In order to prevent the death of fish by poisoning "Jim Brevis" before it could bloom, it now seemed clear that not only must the first outbreak be predicted but it must also be possible to predict the pattern of future successive outbreaks. These were the tasks undertaken by the Miami oceanographers.

A NEW LINE OF ATTACK

First, records of all past outbreaks were examined in great detail. They suggested that when one or perhaps several patches of water become suitable for a red-tide outbreak they might be carried by the system of water currents to other parts of the coast. This new way of attacking the problem has finally given a clue to the prediction of red tides.

The fully equipped seagoing research vessel *Gerda* (see article in vol. 2, No. 2, of *Sea Frontiers*), with all the latest types of apparatus for studying conditions at sea, left Miami for the west coast of Florida. Under the direction of oceanographers Ilmo Hela and Frank Chew, there began a long and exacting study of the water currents and tides in every detail. By working night and day while out at sea they accumulated a prodigious amount of data. Back at the laboratory, samples of sea water were examined chemically and the long task of mathematical analysis began.

A SCIENTIFIC FLEET

Results were checked and analyzed by the use of free drifting buoys and floating cards, whose travel between the time of dropping in the water and the time and place where found gave further evidence of water movement. On occasions a large fleet of yachtsmen, fishermen, and power-squadron members cooperated by dropping cards, identified by numbers, in the waters at numerous places simultaneously. Several days later they returned to locate the cards, floating in their sealed plastic covers.

The complicated pattern of currents changes somewhat with the season of the year, so that it was necessary to repeat the work at sea on a number of occasions. But the interlocking system of currents that gradually unfolded showed how red tide could, apparently haphazardly, jump from place to place, as the affected water was carried along. This led to the next stage in the attempt to predict red tides.

WHAT MAKES WATER MIX

Water flowing in tides and currents and acted upon by wind and wave tends to mix and this would tend to disperse red-tide water. If

a water mass were to remain red-tide active while moving along the coast, it must not mix too quickly with surrounding harmless water and so be dissipated. Therefore, said the oceanographers as they reviewed the results of the *Gerda* cruises, we must next find out just what the conditions are that prevent mixing. These will be the conditions which allow a series of red-tide outbreaks to occur and they may well lead us to a method of prediction.

Chew and his group from Miami worked out a mathematical formula. In simple language it said that "sea water becomes heavier or denser as it becomes cooler or more salt, but less dense as it warms up or becomes fresher. The mixed bay and Gulf water which supports red tides is lighter than Gulf of Mexico sea water. The red-tide water therefore tends to float above the rest. If it is very much lighter, though, it spreads out like an oil film and so begins to disappear. If it is only slightly lighter than the Gulf water it will mix more easily." So, for red tide to progress into a major series of outbreaks the difference in density must be neither too much nor too little.

But how could this density be predicted? Clearly it was related to the amount of brackish water entering the ocean and so to the fresh water entering the bays and this in turn to river drainage and rainfall during the previous months. It was also related to the difference in temperature between Gulf water and bay water and consequently to the air temperature of winds which influence them.

SUCCESS

It seemed a long shot, but after taking meteorological figures for 26 past years and performing numerous calculations with different combinations of the data, a formula emerged which worked. The weather information for any year was placed into the formula. When the numerical result fell within a certain narrow range, then a red-tide outbreak happened during the next 12 months. If outside the range, there was no red tide.

But this was only a start. The test would come when predictions for future years could be checked. Time was of the essence, since a red-tide outbreak is a serious matter to the west-coast residents, and might well cause millions of dollars of lost business if not controlled. So, though a scientist does not like to take chances, it was decided, even before the theory had been fully worked out, to risk a forecast. In November 1955 the State Board of Conservation in Florida was notified that there was little likelihood of major red-tide outbreaks in the year 1956. It turned out that there was none. A similar prediction was made for 1957. The west-coast waters of Florida will be watched with interest to see if it holds good.

WHAT OF THE FUTURE?

There have been no serious outbreaks since 1954. If history were repeated, then public interest would die and research would be dropped. But this time there is a committee watchful of the citizens' interests to guard the future. The U. S. Fish and Wildlife Service may continue to probe the needs of "Jim Brevis," and the cooperating group from Miami may be able to extend its method of prediction so as to forecast the time and place of the next outbreak in order to stop it before it starts.

Already there are indications that a knowledge of tidal movements will play a part in this. Information from the Miami field station at Boca Grande and from the hard-working research ship *Gerda*, combined with the facts growing from the Fish and Wildlife Service studies, may in the not too distant future bring about a sure control of the plague of Florida's west coast, the red tide.

The Return of the Vanishing Musk Oxen¹

By HARTLEY H. T. JACKSON²

[With two plates]

THE MUSK OX, one of those species which had dwindled in numbers so as to be in danger of extinction, at present lives in the wild only on the northeast coast of Greenland and in arctic barrens directly north and northwest of Hudson Bay as far as about latitude 83°, or within 400 or 500 miles of the North Pole. Even within this range musk oxen live only in certain areas, there being large expanses where none occurs. Although today there are no native wild musk oxen west of the Mackenzie River, there is sufficient evidence, from parts of skeletons that have been found, and from stories of the Eskimos, that a few of the animals inhabited Alaska as late as about 1850. At that time the species undoubtedly lived over most of arctic North America and northeastern Greenland. Whereas in those days the number of musk oxen in existence probably numbered in the hundreds of thousands, now a high estimate would be 20,000 individuals, most of which live on the arctic islands.

PHYSICAL APPEARANCE

The musk ox is an odd-looking, hooped mammal that resembles a small, shaggy-haired, miniature buffalo. It combines certain features of cattle with those of the sheep, but is in no sense a connecting link between them. Stocky in build and short legged, a large male measures about 7 feet long, stands a little over 4 feet high at the shoulders, and weighs about 550 pounds. The female is smaller. A hump on the shoulders of the animal reminds one of the bison. Its tail is only three or four inches long, its ears are small, and its eyes rather prominent. Its head is broad and heavy; its face wide and short. The male carries thick down-curved horns, the broad flat bases of which nearly meet over the forehead to form a frontal shield. The horns of the female are smaller.

¹ Reprinted by permission from the Audubon Magazine, November-December 1956 and January-February 1957.

² Formerly biologist with the United States Fish and Wildlife Service.

HOW IT GOT ITS NAME

Although it is not a true ox, the peculiar buffalo-like appearance of the musk ox prompted the name "ox," and the prefix "musk" had its origin in the characteristic musky odor of this animal. The Eskimos call it the *oo-ming-mack*; the Chipewyan Indians, *et-je-ray*. Most species of mammals are known by various names, but "musk ox" is its universal name known to white men, though in olden times it was sometimes called the musk bison or musk buffalo. Even in other languages than our own the term musk ox can be literally translated. For example, in French, the name is *le boeuf musque*.

One might well surmise that any animal adapted to such uninhabited regions as the arctic barrens would be safe from human molestation. To enter the domain of the musk ox, one must take a journey by plane, or by ship amidst arctic ice fields, or else travel by canoe and foot through many miles of Canadian wilderness. Parching winds, cold, and possibly hunger may greet the hunter. Often, miles of search are necessary to locate a herd of musk oxen, for even in an area known to be inhabited by them they live in small scattered groups that shift their range in following the changing food supply. This gregarious habit, this tendency to gather in herds, is a marked instinct in the musk ox, though the groups are usually small ones of from 10 to 30 or 40 individuals, quite in contrast to the huge herds of bison that formerly contained thousands in a gathering. Search for food may induce musk oxen to wander many miles, but there is no regular seasonal movement, or migration, such as is likely to occur in a species that congregates in immense herds or flocks.

FOOD HABITS

Grass is the principal food of the musk ox, though it frequently eats willow browse, small flowering plants, and particularly in summer, the tender shoots of the dwarfed shrubs of its homeland. It is supposed not to like lichens or mosses, but a Mr. Hoare, in an old report for the Canadian Government, says:

The plain on which these musk oxen had been feeding was windswept and only about two inches of snow lay on it so the top of the vegetation was plainly visible. It was evident that the musk oxen had been feeding on several varieties of moss and lichens which the barren land caribou commonly use as winter food. . . . On one side of the moss-covered plain was a gentle slope on which bunch grass could be seen sticking up through the snow. Up this slope the musk oxen had evidently passed, without cropping any of the grass, to the mossy ground above. There was also a thick growth of coarse hay a short distance away on the opposite bank of the river. Grass, willow tips, and flowering plants were quite accessible in the district had the musk oxen preferred these sorts of fodder.

In the winter, herbs and all vegetation of the Barren Grounds are often covered with snow. It is then that the powerful hoofs of the

musk ox come into play as it paws away the snow to obtain its food. At this season it quenches its thirst by eating snow, since all fresh water is frozen over.

AGGRESSIVENESS OF BULLS IN SUMMER

The bulls become rather pugnacious during the summer, and frequent battles ensue between them. Hoare describes a combat which he watched :

About 9 o'clock on the night of June 26, I was resting my pack on a big rock about 3 miles up Hansbury River when I saw 3 large musk oxen feeding on a hay meadow across the river from where I was. They had not seen me so I quickly got behind the rock and went into camp by getting into my sleeping sack. From there I could watch them comfortably without being seen. After some little time two of the three animals stopped feeding, walked out of the wet meadow to some higher dry ground and began circling one another with lowered heads, as if for battle. Each then placed its heavy, horn-protected head against that of its opponent and tried to force it back by main strength. After a short while of this, with little success to either side, each animal backed away a few paces, and ran with lowered head at the other. They came together with considerable shock. Three times they met, with little advantage to either. Then each backed away until they were about 25 paces apart. In their new positions they stood glaring at each other for a few moments, then, as if at a given signal, each bounded at the other on the same instant, gathering speed at they went, and met with such impact that both were knocked back some distance, one on his haunches. The victor stood in fighting attitude for a short while, then, receiving no further opposition from the vanquished, went and lay down. The other soon followed suit. The third musk ox which seemed to be larger than either of the other two, seemed to pay not the slightest attention to the battle but went on feeding in the meadow.

During the breeding season in August the males are particularly combative, and fight each other for control of the females. They do not breed until 4 years old. As with some of the other herding mammals, polygamy is the rule, and each successful bull has a harem of about 10 cows. Sometimes 2 or 3 bulls with their harems gather together into one herd of 30 animals.

BIRTH AND GROWTH OF YOUNG

The baby musk ox is born in May or early in June, and lies for a while hidden in moss or snow. One calf to a mother every other year seems to be the rule. Blackish brown except for a white patch on its forehead and white feet, it is a curious little fellow covered with fuzzy hair or wool. At birth it weighs only about 16 pounds, but at that it is well developed and within a few hours follows its mother.

When the calf is 6 months old, little knobs that form on the forehead indicate the beginning of the horns. By the time a male is 15 months old these knobs have grown into straight horns about 6 inches long that protrude parallel with the ground. As the horns continue

to grow they broaden at the base and bend down and forward in a graceful curve, the ivorylike tips pointing upward.

DEFENSE AGAINST WOLVES AND MAN

Except for man, and occasionally a bear, the wolf is the only real threat to the musk ox. The herding instinct, however, is a great protection to the musk ox, and even the wolf is not often successful in its attack on a group. Several wolves in a pack may at times best a single animal that wanders from the gang. An attack on a herd is a different matter, for the musk ox has a method of defense that defies its enemy. At the least suspicion of approaching danger the bulls surround the calves and cows, and, with heads out and lowered, face the wolves in regular battle array. The cows later may join the battle front, and what a front it is! Each head has a heavy bony shield flanked by two sharp horns that with a single upward thrust might disembowel an unwary wolf and leave it prostrate. No wise wolf would approach such a fortress.

Thus, the musk ox is well adapted to fight its natural enemies of the Barren Grounds. From outside, however, came white men, entirely foreign to the musk ox and its country. Armed with rifles, they had no need to fear that threatening battle formation of horns and shields, for they could kill from a safe distance. Herds of musk oxen were slaughtered without mercy. Now that the species is almost gone, laws and regulations have been passed and reservations set aside for its protection. We hope that it is not too late.

Although robust and clumsy in appearance, the musk ox is not slow on foot, and it can run swiftly. It is able to run up steep hills with surprising ease and speed, and could well escape many of the attacks of man if it chose to run away rather than to stand its ground. Eskimos have long hunted musk oxen for food and clothing, but until the use of the rifle against musk oxen, the killing among the herds had never endangered the existence of the species.

FIRST CAPTIVE MUSK OXEN

The meat of the musk ox is nourishing and tastes like tough beef, but some white men who have eaten it say that it has a peculiar musky taste that they do not relish. The pelt of the musk ox is of very little value to white man, because it is too coarse in hide and hair for him to wear. Eskimos find it valuable for clothing because of its great warmth.

In all the recent attempts to domesticate the musk ox no reference is made to studies on the subject by others; no apparent effort is made to profit by the experience of others in attempting to raise the musk ox, no balance is taken of all known factors, bad as well as good, in meas-

uring procedure. Musk oxen may be seen in a few of the larger American zoological parks, where, once they become acclimated, they may thrive moderately well. The first captive musk ox in America was exhibited in the New York Zoological Park, where it arrived from arctic America on March 12, 1902. In this same zoological garden the first baby musk ox ever born in captivity arrived September 7, 1925. Others have been kept captive in northern European countries, and the governments of Norway and Iceland have experimented in rearing them, but without success. The Dominion of Canada, through protection of the musk ox in its native environment, has increased its population on the Thelon Game Sanctuary, northeast of Great Slave Lake, Northwest Territory, since the establishment of this range in 1927. The only comprehensive study on the musk ox in captivity is that made by the United States Fish and Wildlife Service in Alaska.

In April 1927, the Legislature of the Territory of Alaska sent a memorial to the United States Senate and House of Representatives urging favorable action in appropriating funds to reestablish musk oxen in the range formerly occupied by them in Alaska. During May 1930, under the active leadership of Senator Peter Norbeck of South Dakota and Representative C. C. Dickinson of Iowa, an appropriation of \$40,000 was granted for the project. Administration of it was assigned to the Bureau of Biological Survey, United States Department of Agriculture, now the Fish and Wildlife Service, United States Department of the Interior. It was impossible at that time to obtain live specimens of any of the races of musk oxen that lived in North America. It was necessary to buy stock of the Ward's musk ox, which inhabits northeast Greenland. An order was placed with Johs. Lund, Aalesund, Norway, and late in August 1930 word was received that 34 animals, including 19 females and 15 males, had been captured. All were under 2 years of age and about half of them were calves of the year.

CAPTURING MUSK OXEN IN GREENLAND TO SEND TO ALASKA

The leader of the Norwegian expedition that captured these musk oxen in Greenland, reported on his observations and procedure, as follows:

The animals nearly always appear in flocks but are only seldom met. The older ones range by themselves while the young ones keep together. They are generally guided by a leader. There is much violence in a flock of musk oxen. Once we saw a flock of 18 grazing in a plain. Two of the animals wandered away from each other to a distance of some 50 metres, then took a run and flew against each other. The loser left the battlefield. The animals pasture like cows. Sometimes they will set out at high speed for a distance of 100 to 1,000 metres when they stop short. When attacked they draw up into a flock with

the leader at the head and then make a sally unflinchingly. The animals are swift, and keen of scent, so extreme care must be taken in undertaking to capture them and such hunting is as much as one's life is worth. When the older animals have been disposed of the young are captured alive by use of a lasso made of particularly strong rope. The legs of the young animals are bound together and they are carried aside. The whole affair is a matter of seconds and you must be quick, for the remaining animals might attack you, and even the young ones are not to be trifled with. It is no easy thing to transfer the animals to the vessel. There is likely to be some trouble. The year-old calves are easily caught and managed. It is a great advantage that they have no horns. About two or three men are able to manage such a calf with their bare hands. By means of a muzzle or halter we contrived to get them on board the boat. Many are rather refractory but we leave them as much as possible to themselves during the transporting. Then we get them into the whaling boat and upon reaching the ship's side we heave the whole boat on deck with the animals in it. We then put them in spacious and solid cases made of two-inch boards. At first the animals try their strength against the side of the cases, but when after a while they understand that the cases are stronger than themselves they give in. After a day or two they begin to feed. It is no use to give them hay or grass grown in contaminated fields as the animals fall ill with such grass and hay, and die. They are very particular although hardy; for instance, they never taste water that is not entirely fresh. They soon get used to man. Having been in the crates on deck for about a week they easily understand that there will be a dainty tidbit when members of the crew approach with grass or moss. The young ones are the most easily naturalized. Therefore, we catch young animals by preference.

HOW THE MUSK OXEN WERE SHIPPED TO ALASKA

Transported in crates to Bergen, Norway, the 34 musk oxen on September 6, 1930, were shipped from there on the Norwegian-American liner *Bergensfjord* to New York, where they landed September 17. The newcomers were received at the port by the late L. J. Palmer, then in charge of the United States Biological Survey experiment station at College, Alaska, the late E. A. Preble and the late W. B. Bell, both at that time of the Washington office of the United States Biological Survey. In order to insure against the introduction of some of the many diseases of hoofed animals, such as foot-and-mouth disease, rinderpest, and surra, the animals were held in quarantine for 33 days at the Bureau of Animal Industry Quarantine Station, Clifton, N. J. Two 72-foot steel express cars then carried the animals to Seattle, where they were transferred to the steamship *Yukon* of the Alaska Steamship Line and reached Seward, Alaska, 7 days later. Four ordinary freight cars with a temperature of 20° to 40° carried them over the Alaska Railroad to College, Alaska, where they arrived the night of November 4, and the next day, with the temperature at 16°, were unloaded and released in a 40-acre enclosure on the College of Alaska campus. During their American journey the animals were in roomy, individual crates, and were fed alfalfa hay and given an abundance of water. They all reached their

destination in excellent condition. Most of the animals were not wild and were easily driven. One or two of the smallest ones even yielded to petting and handling. Food for their first Alaskan winter was varied for tests, but they were successfully fed on a number of grasses, including alfalfa hay, oat hay, brome hay, and native hay (sedge and redtop). Each animal ate about 5 pounds of food daily.

A SIX-YEAR STUDY OF CAPTIVE MUSK OXEN

And so began the unique 6-year study of confined musk oxen. Charles H. Rouse and the late Lawrence J. Palmer, two outstanding authorities on range management and animal husbandry, conducted the research. Each had had practical experience with range cattle, sheep, and horses; each, a thorough university education in range management; each, long, close contact with big game in the wild. Early in the spring of 1931 the animals were released in a 4,000-acre fenced enclosure of the 7,559-acre pasture included in the experiment station grounds. Soon it was noticed that the 4,000-acre pasture was too large and the herd was then confined to a pasture of 1,077 acres of which 600 acres were summer pasture, 325 acres spring pasture, 82 acres fall pasture, and 70 acres winter and hay meadow. Smaller pastures were fenced for isolating a few musk oxen for observation or study. Corrals were constructed and a loading chute built for easier handling of the animals.

Three years later, June 30, 1934, of the original 34 animals, 24 had survived—12 breeding-age cows and 12 bulls. Ten deaths in the herd had occurred—five animals were killed by black bears, one cow had a broken leg, one died from meningitis, one from actinomycosis, and two from some unknown sickness. Between April 29 and June 24, seven calves were born of which five lived. One had been stillborn and another died from injuries received from a bull musk ox.

The spring of 1935 was a rewarding one, for each adult cow gave birth to a calf, though in one case of a stillborn calf, the cow also died. The herd then comprised 12 adult bulls, 11 adult cows, and 15 immature, or young ones; a total of 38 musk oxen, the highest number reached at the experiment station. No calves were born in 1936, and through the deaths of seven animals and the transfer of four to Nunivak Island for adaptation studies, the herd was reduced in June to 27 animals. It is believed that the cows that gave birth to calves, both in 1934 and in 1935, did so because their previous year's calves were separated from the cows in the fall of 1934. The following year of 1936, the calves were not isolated from their mothers, therefore were not weaned, and the cows did not breed. In the wild, natural condition on its native range, the musk ox does not wean its calf until the second summer and so breeds every other year.

CAN THE MUSK OX BE DOMESTICATED?

Hope for domestication of musk oxen was high in the early stages of the study at the Alaska Experiment Station. It was first believed musk oxen were less difficult to drive and corral than reindeer. As the animals aged they became untractable and hard to handle. They broke down strong fences. They were belligerent. Familiarity with humans had made the musk oxen fearless of their captors. Even though they were given excellent care and attention, they nevertheless were susceptible to diseases and infections, such as meningitis, actinomycosis, lip-and-leg ulceration, stillbirth, and pneumonia. Black bears were destructive to them. Mosquitoes bit the eyes of the musk oxen. Some animals were so badly bitten by mosquitoes that they were temporarily blinded and in running through the brush seriously damaged their eyeballs.

Alaskan experiments were made on the possible commercial use of the musk ox. Valuable wool constitutes about 60 to 80 percent of the hair, the remaining 40 to 20 percent is coarse guard hairs. The wool is one of the finest known, comparing favorably with that of cashmere or even vicuna. The difficulty would be to obtain pure wool in quantities. Clipping the animal may result in its death. Moreover, clipping produces a mixture of wool and guard hairs, and no process, mechanical or manual, is known by which the wool can be separated economically from this mixture. The musk ox sheds its wool beginning about the middle of May and up to the middle of June. It can, at that time, be combed from the oxen, which, again, endangers their lives either through shock or pneumonia. Wool can be collected from objects on which it has attached itself as the animal passed, but this would be too slow and tedious a way to get quantities of wool for commercial use. Nevertheless, close to 100 pounds were thus gotten at the Experiment Station, and much of it used in experimental textile work at the University of Alaska in making scarves, stockings, and mittens. The flesh of the musk ox is edible, but most people would prefer beef, mutton, or pork. Moreover, the quantity of better meat cuts from musk oxen is meager, because of their heavy necks and foreparts, which produces a relatively small meat salvage in butchering. The milk of the cow musk ox is as good as cow's milk according to some who had nothing but "tinned" cow's milk for comparison. But the cow musk ox produces no milk until it is 5 years old, and then the quantities are small.

CONCLUSIONS ABOUT THE COMMERCIAL USE OF MUSK OXEN

The experiments conducted by the United States Fish and Wildlife Service near Fairbanks, Alaska, clearly indicated that it is entirely impracticable to raise musk oxen as a farming or commercial enter-

prise, and any attempt to do so should be regarded only as an expensive experiment almost certain to fail. The primary purpose of the studies in Alaska, which were to learn how best to adapt the introduced Greenland animals to Alaskan conditions with a view to establishing the species there, bids fair to be successful. The 4 animals transferred to Nunivak Island Wildlife Refuge in 1935 had done well; however, the herd at the Alaska Experiment State had become such a problem that the 27 musk oxen remaining there were transferred to Nunivak Island and all were released on the refuge on July 17, 1936. These 31 animals were all that remained of the original 34 and their offspring. Nunivak Island was selected for this introduction after careful consideration of all factors—there were no predators there, few disease hazards, and a favorable environment. The island is 70 miles long by 40 miles wide, and is in the Bering Sea, some 25 miles from the Alaskan mainland, directly west of the mouth of the Kuskokwim River. Here the musk ox herd has done well. In the autumn of 1951 an accurate count by airplane showed 76 musk oxen on the island, 7 of which were calves. A stock of musk oxen when left alone in the wild in Greenland tends to double its number in about 11 years. The Nunivak herd has maintained this rate of increase.

I do not discredit the effort to raise musk oxen as experimental research. I cannot, however, condone the high-pressure sales propaganda that has developed about raising musk oxen commercially. Says the advertising, "This will be the first new animal to be domesticated since the Copper Age." This is pure bunk! Many animals, both birds and mammals, have been domesticated since the Copper Age—among mammals, the silver fox, mink, chinchilla, golden hamster, Chinese hamster, and cotton rat. High-pressure advertising has developed false hopes about raising musk oxen. Already it has influenced people to risk their money in raising the musk ox as a commercial venture, an investment which is more "wildcat" than "musk ox." My advice is "Do not gamble on musk ox farming."



Musk oxen at the United States Biological Survey Experiment Station, College, Alaska. This is part of the herd that was brought from Greenland with the hope of reestablishing the musk ox in Alaska.



1. Something is wrong. An enemy is suspected near, and the small group faces it, as in battle formation, with shoulder humps raised in a demonstration of anger.



2. The musk ox, somewhat resembling a small shaggy buffalo, is an odd-looking animal. Note the broad frontal shield formed by the wide bases of the horns, the long hairs hanging in fringes, the hump on the shoulders and the pale saddle just back of it.

Bamboo in the Economy of Oriental Peoples¹

By F. A. McCLURE²

*Plant Introduction Section
Agricultural Research Service
United States Department of Agriculture*

[With 10 plates]

BAMBOO is fascinating alike to the artist, the poet, the craftsman, and the scientist. The Western traveler in the Far East has never failed to be intrigued by the ubiquity of bamboo and by the number of ways in which it enters into diverse phases of the life of the people. He has been struck by its beauty as an ornamental and by its astonishingly varied role in the arts and industries. He has listed its multitudinous uses, praised its virtues, and advocated its incorporation into Western agricultural and industrial economy.

BAMBOO AS A GARDEN ORNAMENTAL

Bamboo is an essential feature of many planned landscapes in the Orient: the elaborate and extensive gardens characteristic of the Golden Era of China, the more restricted type peculiar to Japan today, the relatively tiny secluded inner court of inn, teahouse, or private dwelling where there may be room for little more than a bamboo screen (pl. 1, fig. 1). In Oriental gardens we find living bamboos used as hedges, borders, and screens, in mass plantings, in groves, and in isolated clumps. Dwarf forms are often used, in Japan at least, as ground cover for open parklike areas, and especially under pine trees.

Some bamboos are suited to a great variety of treatment, while others are less responsive to the skill of the gardener. The most tractable are the ones commonly employed in pot culture. Several types of manipulation are practiced to produce either dwarfed speci-

¹ Reprinted by permission from *Economic Botany*, vol. 10, No. 4, October-December 1956.

² Present address: Research Associate, Smithsonian Institution, Washington 25, D. C., care of Department of Botany.

mens or bizarre topiary effects. The dwarf habit is sought especially in connection with the production of miniature gardens, though many dwarfed specimens are cultivated individually in pots or trays solely for exhibition.

Dwarfness may be a natural state related to genic constitution, or it may be the result of cultural treatments involving controlled watering and restricted nutrition. Certain devices are employed for simulating the dwarf habit by more direct methods to avoid spending the time required for bona fide dwarfing. Sometimes a bamboo culm of large dimensions is separated from its mother clump, cut down to a short stump, and transferred to a suitable pot just before new growth starts. The ensuing growth is greatly reduced from the normal size, and the presence of the stump itself is considered, by a certain school of gardeners and plant fanciers, to enhance the artistic merit of the general effect. This treatment is usually practiced with bamboos of the clump type of growth, where the new shoots originate from the base of the mother culm.

Another method is used with bamboos of the running type, in which the new culms normally arise from lateral buds of the slender horizontal underground rhizome. A young section of the rhizome with dormant buds is dug up and set upright or at a slight inclination from the vertical, in a suitable receptacle, with the basal 3 or 4 inches covered with soil. The exposed portion soon turns green in response to light. The buds that develop under the soil produce greatly reduced culms, while those that develop above the soil send out short leafy branches. The net effect of the small stature of the slender culmlike rhizome with its short internodes is a deceptive appearance of dwarfness that is often very pleasing to the uninitiated. To the expert, be he professional or amateur, this device is but an obvious humbug.

In another procedure, the culm sheaths, which normally protect the tender growing part of the young culm, are removed prematurely. As a result, elongation of the culm is stopped. Plants of a naturally small stature, and of either type of growth, may be used for this treatment.

Where the climate is sufficiently warm, young plants started from depauperate offshoots of a dwarf form of *Bambusa multiplex* make most satisfactory subjects for tray gardens and miniature mountain landscapes. Bamboos having naturally some bizarre character, such as the shortening of the internodes that occurs in *Phyllostachys aurea*, *Bambusa ventricosa*, and *B. vulgaris*, for example, or the square form of internodes and prominent spiny nodes in *Chimonobambusa quadrangularis*, or the green-striped golden culms characteristic of certain horticultural forms of *Bambusa vulgaris*, *B. multiplex*, and *Phyllostachys bambusoides*, are given special attention in gardens.

Many species and varieties of bamboo are highly esteemed as ornamentals. Plants of various species of *Sasa* and *Phyllostachys* are perhaps most numerous among the bamboos in Oriental gardens, partly because of their ease of culture and their natural decorative value, and partly because, in the Orient, gardening reaches its highest state of development in the warm-temperature climate preferred by these genera. Three tropical species deserve special mention because of their striking appearance and popular appeal. These are the white powdery bamboo (*Lingnania chungii*) of southern China, the monastery bamboo (*Thyrsostachys siamensis*) of Thailand, and the giant bamboo (*Dendrocalamus giganteus*) of India. The first, as yet unknown in the West, has been highly esteemed and even memorialized by Chinese poets and artists since very early times. The last is widely known and greatly admired in the West as well as the East, for the unique size of its culms which attain truly gigantic proportions.

In Japan various parts of bamboo are regularly used for their decorative effect. The full-grown leafy culms are often massed together for temporary background purposes. After the leaves have fallen, the dried culms, with their branches bedecked with colored paper streamers or gleaming lanterns, are set up for all manner of festive occasions. Large bouquetlike arrangements, in which three culm sections of unequal length form the central element, with evergreen branches massed about the base, constitute a more formal type of ornament. In all objects made of bamboo, whether flower vases, ornamental baskets, figurines, children's toys, or any of the thousand and one objects of everyday use, the natural decorative value of the culms or other parts of the plant is always presented to advantage.

BAMBOO IN PAPERMAKING

Bamboo occupies a very important place in the ancient handcraft of papermaking in the Orient. Not only is the greater part of the paper used in the Far East composed of bamboo pulp, but until recently practically all of it was made on molds, the essential part of which is fashioned from slender strips of bamboo wood.

Establishment of a paper mill is conditioned upon the availability of a sufficient supply of pulp material within easy reach. The industry depends also upon a steady supply of clear water and a cheap source of the digesting materials, such as quick lime, soda ash, or potash. The methods employed in the old mills where paper is made entirely by hand are of a very primitive nature and are, for that reason, not adequate for refining the highly lignified tissues of mature bamboo culms. Therefore, the better grades of paper are made from young culms only—those that have not yet put forth their leaves. For cheap papers the requirements are less exacting, and a

wider range of bamboo species is employed as a source of pulp. In fact, it is probable that any local species in sufficient abundance and available at a reasonable price may be used. For making some of the very coarse dark papers of common use for filters, wrappings, etc., mature stems are acceptable. The tips of the mature clumps, a by-product of the split-bamboo industry, are so employed in southeastern Asia. The time allowed for digestion is very long, often a full year, and the pulping methods are not highly refined.

In the construction of the common type of mold, on which the finest paper is still made by hand in the Orient, bamboo is always used. The essential part of the mold is a flexible screen of slender wirelike units fastened together in parallel array by means of hair, silk, or ramie. The best screens are made from the peripheral wood of large culms of *Phyllostachys pubescens* or *P. bambusoides*. After preliminary splitting, the strips are reduced to the desired size and to a cylindrical form by being pulled through a hole in a piece of steel, after the manner of wire drawing. In this way wirelike strips of marvelous uniformity and fineness may be produced. Some screens have as many as 32 strips to the inch. The finished screens, after having been treated with lacquer, are objects of great beauty and unbelievable durability. The binding fibers, which correspond to the warp in weaving, are the first part of the screen to wear out. When a screen has been in use many years and can no longer be repaired, the bamboo strips are salvaged and reworked into a new screen.

Bamboo finds numerous other more or less incidental uses in the average Oriental mill where paper is made by hand. The half-stuff is carried from the digesting vat to the bamboo treading trough in bamboo baskets suspended from a bamboo pole. The finished pulp is "combed" by means of a bamboo loop to remove coarse fibers ("shives") which have escaped reduction by digesting and treading. Upon addition of water, after it has reached the dipping vat, the pulp is agitated by means of a bamboo stirring rod to effect an even dispersal of the fibers. The vatman and the drier work by the light of a bamboo lamp at night. Bamboo rope is used on the windlass for applying force to the press. Bamboo forceps are used to pick up the corners of the wet sheets from the block as it comes from the press. Old bamboo culms that are too highly lignified to make pulp by hand methods are commonly used as fuel for drying the paper. The bales of finished paper are often covered with bamboo culm sheaths and bound with bamboo bands. A bamboo tool, combining the functions of a gauge and an awl, is used to space the bands upon the bales and tuck in the twisted ends.

The principal technical problems arising in connection with the use of bamboo for paper pulp in modern mills have been solved, and

many variants of the process have been patented in those countries where paper is made on a large scale. At least one of the several modern paper mills established in China under an earlier regime used bamboo exclusively as a source of pulp, and it is claimed that 90 types and grades of paper were made, ranging all the way from wrapping paper and tissues to bond and ledger.

As a result of long and careful pioneering experiments by William Raitt, and more recent studies by Indian technicians working at Dehra Dun, India leads the Oriental countries in the volume of bamboo pulp produced. Indian mills are now turning out bamboo pulp at a rate approaching 250,000 tons per year, principally from the culms of *Dendrocalamus strictus*. The major portion of this is used for blending, to upgrade inferior pulp made from herbaceous grasses and short-fibered hardwoods. In Thailand a modern mill makes paper entirely from bamboo, but the total amount and the identity of the species used have not been reported. Indonesia and Burma both have plans on foot for building modern mills to convert a part of their vast bamboo resources into paper. Pakistan has just completed an ultramodern mill designed for an initial production of 30,000 tons of bamboo pulp per year, principally from the culms of *Melocanna baccifera* (pl. 2, fig. 1). Japan is producing paper by modern methods on an experimental scale and plans for expanded facilities are under way. The species of principal interest there is *Phyllostachys bambusoides*.

BAMBOO AS A TEXTILE

A great many objects of common domestic and industrial use are fashioned entirely or in part from woven bamboo. These have the qualities of lightness and flexibility, and there is about them an artistic appeal not to be found in any other equally cheap material.

Bamboo has numerous characteristics that fit it especially for weaving purposes: straight grain, ease of splitting, flexibility, toughness, natural gloss, and lightness in proportion to volume, to mention the more obvious ones. The individual textile units are long, thin, tangential segments of the outer layer of the culm, with the epidermis occupying the greatest possible dimension. As prepared for most purposes, these units vary up to about 8 feet in length, from one-fourth to three-eighths of an inch in width, and from one-sixteenth to three-sixteenths of an inch in thickness. For certain types of basketry and matting these may be much narrower or much wider. For very fine matting the outermost layer is removed to make the strips perfectly flat and to eliminate the unevenness occasioned by the nodal rings, and the finished strips may be but one-sixteenth of an inch or less in width, and exceedingly thin. For certain kinds of sawale (a type

of matting common in the Philippine Islands, whence comes the name, and in southeastern Asia generally), the culms are first cracked at several points around each node, then opened by a single longitudinal slit. When the diaphragms have been removed, the culms are spread out flat.

BAMBOO IN BASKETRY

In the Orient bamboo baskets and trays enjoy a usage more varied, perhaps, than that accorded any other bamboo article. This is true in the outer world of industry and transportation as well as in domestic circles where there is still much fetching and carrying to be done and where drying is the prevailing method of preserving foods. The Orient possesses no material, other than bamboo, that is available in such abundance or is so well suited to the construction of light, convenient, attractive, and inexpensive baskets and trays.

Baskets of a design peculiar to the individual need are used by money changers, carriers of sand and earth, tenders of newly hatched chicks, wholesale food merchants, dealers in crude drugs, and peddlers of fish, fruits, and vegetables. Baskets in an infinite variety of shapes and weaves are available, particularly in Japan, for the decorative arrangement of flowers and fruits. For the farmer's wife, the herbalist, and the maker of candied fruits, bamboo trays provide a cheap, light, and convenient means of exposing things to the sun and of gathering them up again quickly when rain threatens. Bamboo baskets and trays constitute an important item of equipment required for many large-scale industrial and commercial pursuits in the Orient. In the silk industry the mulberry leaves are brought from the field in bamboo hampers, while the silkworms are hatched, and spend the whole of the caterpillar stage, on bamboo feeding trays. As a fitting finale they are placed, when mature, upon racks fashioned from bamboo in a form suggesting treetops where, in the wild free state, their ancestors spun their cocoons. The shape of these spinning racks is cleverly designed, however, in deference to the requirements of space economy.

In southeastern China, pig crates, chicken baskets, and tree protectors (pl. 1, fig. 2, and pl. 5, fig. 1) are made from heavy strips of the culms of *Bambusa tuldooides* and related species. In this same region trays and baskets are woven principally from thongs of *Bambusa textilis*, while certain heavier parts, such as the stays and rims, are usually made from *Bambusa tuldooides* and similar kinds. In more temperate regions, including Japan, various species of *Phyllostachys* are used for all parts of these containers (pl. 7, fig. 1). In more tropical regions a wide array of species, chiefly of the genera *Bambusa*, *Dendrocalamus*, *Melocanna*, *Gigantochloa*, and *Schizostachyum*, yield basket-making materials.

Stones used in the construction of dams and in the repair of dykes are held in place by being confined in cylindrical baskets of bamboo (pl. 2, fig. 2) of the same general pattern as the pig crates and tree protectors mentioned previously.

BAMBOO MATTING

Bamboo matting is woven in a great variety of shapes and patterns and is employed in many ways in the Orient. One sort, of incredible fineness and flexibility, is used in China as the equivalent of bed sheets and pillow cases during summer weather. Long narrow strips of a sturdy tight-woven form are used by itinerant duckherds for corralling the fowls at night, and by farmers for making demountable grain bins. Fruits and other products which would be spoiled by contact with the soil are spread out to dry on squares or rectangular pieces of coarse bamboo matting. Similar mats are used as overnight covers or during showers to protect farm produce being cured or dried in the sun. Bamboo mats are made in various sizes and weaves for use as a covering for the walls and partitions of bamboo dwellings (pl. 3, fig. 1) and more temporary structures. Matting of open weave serves to reduce the light to an intensity suitable for orchid culture, while sunshades and windbreaks of close-woven bamboo mats are often erected for the protection of other delicate horticultural crops. On certain types of water craft, bamboo mats serve as shelters against the elements and on occasion as emergency sails. The "sea anchors" employed to harness the current for steadying boats engaged in fishing or dredging are made of bamboo matting. Fences made of coarse bamboo matting may also serve as windbreaks or screens for privacy.

Most matting is uncolored and depends for its ornamental appeal upon the weave pattern. Sometimes, however, interesting color patterns are produced by using dyed strips of various hues. Stage settings are sometimes composed of scenes painted on bamboo matting. Plain bamboo matting is effectively used as a background for the display of paintings and objects of art.

The Institute of Science and Technology, at Manila, has recently conducted successful experiments in the use of fine bamboo matting as a stress skin for airplane fuselages. The bamboos used are reported as *Bambusa spinosa* and *B. vulgaris*.

In Japan and the temperate parts of China various species of *Phyllostachys* yield the strips used for matting. In southern China, *Bambusa textilis* is the matting bamboo par excellence. In the Philippine Islands matting is made principally from the culms of *Schizostachyum* spp., while in the more southerly parts of Asia and in Indonesia and adjacent islands those from *Bambusa*, *Dendrocalamus*, *Gigantochloa*, *Melocanna*, and *Schizostachyum* are used.

We usually think of matting as a woven product, but there is a kind called "smooth matting" made in China by another method. These mats are constructed by stringing together, edge-to-edge, partially split sections of the culms of *Phyllostachys pubescens*. Flawless sections are selected from the lower middle portion of large culms where there is the least taper and no branches. These are cut to a length precisely equal to the width of the finished mat. The external nodal projections are planed or scraped down to the level of the rest of the culm surfaces. Each section is then split into strips about an inch in width, and these are kept in their original order. The fragments of the diaphragms are now removed and the strips are again split at intervals of perhaps an eighth of an inch this time through only about two-thirds of their length and alternately from the two ends. These inch-wide strips may now be flattened out. They are laid, one by one, outer side down, on a flat surface and drilled tangentially with three pairs of holes (one pair at the middle and one near each end) always precisely located. The different sets of strips from the several culm sections are now matched, planed on the edges where necessary, and then strung together on heavy cotton cord. Such mats are used chiefly for covering beds and cots for summer use in warm climates. The upper side, which is formed by the outer waxy surface of the bamboo, takes on a pleasing natural polish with use and provides incredibly cool and comfortable sleeping conditions in the hottest weather.

BAMBOO ROPE

Ropes made from bamboo are used more extensively in China, perhaps, than in any other Oriental country. They have several points of distinct superiority over ropes made from other fibers. This is especially true where the rope is frequently wetted or subjected to an unusual amount of abrasion, as in the drilling of wells, the pumping of salt brine, and the towing of boats.

Two general methods of manufacture are used. The easier and more common method is essentially like that by which rope is made in the West by hand, the same twisting devices and "rope walk" being employed. It consists simply of the operations involved in twisting the individual strips together. The primary units may be further united, by twisting, into successively larger units until cables of prodigious size, up to 2 feet in circumference, may be made. Such great ropes are employed only in constructing mighty cable bridges or in the repairing of important dikes during a flood.

A much more durable type of rope is plaited or braided in a tubular form, but this can be made only in rather slender sizes. The work is performed in a tower, and the rope is lowered to the ground as it is finished. It is much more tedious to make this kind, but it has a con-

siderably greater tensile strength per unit of weight than the twisted sort. For tracking purposes (towing river boats by manpower), the superiority of the braided rope is outstanding. Being of open construction and consisting of coarse units, it holds less water and dries more quickly after having been submerged. Again, in places where the towpath swings around the convex side of a rock cliff, the rope often rubs against the rough surface under considerable tension. When the plaited type of rope becomes damaged by this hard usage, individual strips may be replaced, thus restoring it more or less completely to its original condition. When this rope becomes so aged or worn that it must be discarded, it is cut into convenient lengths, dried, and used for torches.

Small bamboo ropes of the twisted type are commonly employed for such temporary functions as binding together the units of rafts made up of lumber, fuel wood, or bundles of bamboo, for transportation by water. When these rafts are moved by means of the stream current or the tide instead of being towed, guiding, braking, and anchorage are miraculously accomplished by means of stone-weighted wooden anchors attached to the stern by means of bamboo rope, and floated intermittently upon smaller, trailing bamboo pilot rafts. The passage boats operated on the inland watercourses are towed by means of large twisted bamboo ropes or cables. Bamboo ropes are used in western China for drilling salt wells and for hoisting brine.

BAMBOO AS A BUILDING MATERIAL

In vast areas, bamboo is the one material that is sufficiently cheap and plentiful to fill the tremendous need for economical housing (pl. 3, fig. 1). Bamboo is employed in many ways, often as much for its ornamental value as for its superior fitness in homes built primarily of more substantial and more costly materials. It is eminently suited and economically desirable for the construction of all parts of a house. It serves admirably for the builder's scaffolding as well. The natural units, or culms, are of a size and shape that make handling, storing, and processing both convenient and inexpensive. The characteristic physical structure of the culms gives them a high strength-weight ratio. They are round or nearly so in cross section and usually hollow, with rigid crosswalls strategically placed to prevent collapse on bending. The strong, hard tissues of great tensile strength are most highly concentrated near the surface of the culm walls. In this position they can function most effectively, both in giving mechanical strength and in forming a firm resistant shell. Because of the nature of their substance and grain, bamboo culms are easily divided by hand into shorter pieces by sawing or chopping, or into narrow strips by splitting. No costly machines are required; simple tools suffice (pl. 4, fig. 1). The

natural surface of most bamboos is clean, hard, and smooth, with an attractive color when the culms are properly matured and seasoned. Bamboos have little waste and no bark to remove.

The construction of bamboo walls is subject to infinite variation, depending on the strength required for resistance to natural forces, such as earthquakes and hurricanes, and protection from rain and ordinary winds. Either whole culms or longitudinal halves may be used. They are arranged either horizontally or vertically. In the vertical position they function more effectively and are more durable because they dry more quickly after a rain.

For practical reasons window and outside door openings are kept to a minimum, though they must be sufficient to supply the needed light and ventilation. They may be framed with wood or bamboo. The doors themselves may be wood, or they may be woven bamboo matting stretched on a bamboo frame. A panel of bamboo boards is sometimes set in a hardwood frame. A sturdy gatelike barrier may be constructed of whole bamboo culms. Bamboo window bars often take the place of iron or steel ones, and bamboo window shades are common.

Serviceable and attractive floors may be made entirely of bamboo. The principal features are the supporting beams, which are part of the basic frame of the house, and a floor covering. The floor covering may be of small whole culms, strips, or bamboo boards made by opening and flattening out whole culms. In this last case the floor is generally fastened down by thin strips of bamboo laid transversely and secured to the supporting members by thongs, wire lashings, or small nails, according to local preference and the materials available. Bamboos are utilized to excellent advantage in roof construction because of their high strength-weight ratio.

It is common practice in the Orient to complete scaffolding to its full ultimate height before a building is started. In the more tropical regions this is topped off by a thatched roof as a protection against sun and rain during building operations.

Bamboo scaffolding is very often erected against apartments and private dwellings to support bamboo matting for shedding sun and rain during summer. Bamboo screens give privacy in crowded communities.

BAMBOO SHELTERS AND OTHER MORE OR LESS TEMPORARY STRUCTURES

One of the simplest examples of a temporary bamboo structure is the roadside shelter erected by the impecunious dispenser of cheap refreshments who expects to carry on his business at a particular spot only during the course of a local fair or the run of an itinerant the-

atrical troupe. Such a shelter may consist of little more than four bamboo posts set in the ground and surmounted by a rough lattice of bamboo culms to support a thatch of grass or palm leaves. If the proprietor spends the night there, three sides may be covered with bamboo matting supported by a few extra bamboo crossbeams and braces. Shelters for an agricultural or industrial fair or flower show are put up by a commercial mat-shed builder on a larger scale and more securely. Itinerant theatrical troupes employ bamboo structures of a distinctive architecture, tall and narrow, with the walls often covered with gaudily decorated mats, and surmounted by ornamental devices of traditional rococo design. The floor, which is elevated several feet above the ground, is made of thin wooden planks laid on bamboo beams and held in place by thin strips of bamboo bound down by bamboo thongs. The top-heavy structure is held erect by means of long bamboo braces, to which is often added the security of bamboo guy ropes.

Mention of these theaters, built for short gala festivals, calls to mind the much more highly ornamented and even more transient "triumphal arches" or gateways erected over the road to be traveled by an honored guest or a conquering hero. In these triumphal arches the versatility of bamboo as a building material and a decorating medium is exhibited to fine advantage.

BAMBOO IN ORIENTAL FURNITURE MAKING, COOPERY, AND JOINERY

The furnishings of a house may be more or less predominantly of bamboo construction, depending upon the pecuniary circumstances or the artistic tastes of the family. The kitchen stools, the baby's play chair, the sofa used for the afternoon siesta in torrid weather, and the settee on the veranda or in the garden pergola are all articles of furniture commonly made of bamboo. The species used for this purpose vary locally, but in the more temperate parts of the Orient most of them belong to the genus *Phyllostachys*. Now and then one will see a treasured settee or a tea table fashioned from the brilliant purplish-black culms of *Phyllostachys nigra*. In more tropical areas various species of *Bambusa* enter into furniture making. Bamboo dowel pins are commonly employed by carpenters for joining boards edge-to-edge in the making of certain articles of furniture such as beds and wardrobes. The best dowel pins are made from the rind wood of *Arundinaria amabilis*. *Phyllostachys pubescens* is also used.

Bamboo enjoys enormous usage in the Orient in the form of hoops. The large wooden tubs used in the pickling and food-processing industries are commonly bound with bamboo hoops (pl. 5, fig. 2). These are more resistant than iron hoops to the action of salt and vinegar. While wooden water buckets and wash basins are almost always first

bound with iron hoops, when at length these give out the itinerant repairman replaces them with bamboo.

Bamboo hoops are always made up of a number of slender strips (pl. 5, fig. 2). These are fabricated into a circular unit of the desired dimensions either by twisting or by plaiting. The plaited form is more durable and probably has a greater tensile strength per strip unit. The twisted form is easier to make and is, therefore, cheaper. An important feature of the technique of making both sorts is keeping rind or outer surface of the strips always on the convex side of a bend or curve.

Bamboo hoops of the plaited type are indispensable in the oil-pressing industry, being employed to form, along with rice straw, the outer shell of the cylinder which confines the oil-bearing meal while it is under pressure. The meal is wrapped in straw in the form of disk-shaped packages, each supported on its periphery by several bamboo hoops. The units are placed side by side in the primitive wooden press which is operated by hand on the percussion principle.

We do not ordinarily think of bamboo as a wood appropriate to the joiner's art. However, the making of the bamboo buckets and tubs used as containers for cooked rice is a trade in itself. Some 30-odd tools, each with a special function, compose the kit of the maker of these bamboo vessels!

BAMBOO BRIDGES

A very ingenious device is often erected for transporting persons, goods, and animals across deep swift streams, particularly in the mountainous borderlands between China and Tibet, where few bridges are available. This device consists of a strong cable fashioned of split bamboo and having a diameter commensurate with its length and the weight of the load it is likely to bear. The following description is taken from E. H. Wilson, "A Naturalist in Western China," vol. 1, p. 164, 1913:

These simple but extremely useful structures consist of a bamboo hawser stretched across the stream usually from a higher to a lower point; if the stream is moderately narrow the question of incline is of less importance. The hawser may be anything from 8 inches to a foot thick, and being heavy sags considerably in the middle. To cross one of these cable bridges a person is supplied with a length of strong hempen rope hanging free from a saddle-shaped runner of oak or some other tough wood. The runner clips the cable, and the hempen rope is fastened under and around the legs and waist to form a cradle. When all is properly secured the person throws one arm over the top of the runner, gives a slight spring, and glides down the inclined cable at an increasing speed. The impetus obtained in the downward rush carries the passenger over the central dip and more or less up the lesser incline on the opposite side. If the momentum is insufficient to land the person, the remain-

ing distance has to be traversed by taking hold of the hawser and hauling hand over hand. Crossing by these bridges is fearsome work until one is accustomed to it. It is speedily accomplished, and there is practically no danger so long as one keeps a cool head and the ropes do not break. It is a common sight to see men with loads and women with children on their backs cross these bridges. But heavy loads are usually fixed to the runners and hauled across by a rope attached to them.

These cables are used in another very interesting manner to expedite and make safer the crossing of some of the streams which are too swift for ordinary navigation. Here the cable is suspended at a height of a few feet above the surface of the water, and instead of the "saddle," a boat is attached to the wooden "runner." Then the force of the current, which would otherwise carry the boat downstream in spite of all human efforts, is transformed by means of an oar or rudder set at the proper angle into lateral thrust which carries the boat quickly from one bank to the other (pl. 6, fig. 1).

The next natural step in the evolution of these structures is as a suspension bridge which may well be considered the prototype of our modern ones, of which the Brooklyn Bridge is a well-known example. Thinly populated mountainous western China boasts the most magnificent of these, and for the following description we are likewise indebted to E. H. Wilson (op. cit., p. 171):

This remarkable structure is about 250 yards long, nine feet wide, built entirely of bamboo cables resting on seven supports fixed equidistant in the bed of the stream, the central one only being of stone. The floor of the bridge rests across 10 bamboo cables, each 21 inches in circumference, made of bamboo culms, split and twisted together; five similar cables on each side form the rails. The cables are all fastened to huge capstans, embedded in masonry, which are revolved by means of spars and keep the cables taut. The floor of the bridge is of planking held down by a bamboo rope on either side. Lateral strands of bamboo keep the various cables in place, and wooden pegs driven through poles of hard wood assist in keeping the floor of the bridge in position. Not a single nail or piece of iron is used in the whole structure. Every year the cables supporting the floor are replaced by new ones, they themselves replacing the rails. This bridge is very picturesque in appearance, and a most ingenious engineering feat.

BAMBOO IN THE FISHING INDUSTRY OF THE ORIENT

To most Americans "bamboo" and "fishing" are ideas almost as intimately associated as are the words "bread" and "butter." Indeed, for many the term "fishing pole" is synonymous with the word "bamboo." In the Orient, however, this association is very much more profound and intimate, as well as more ancient. This fact may be verified by anyone, even though he may not be privileged to see the varied bamboo gear that is an essential part of the Oriental fisherman's paraphernalia. It is sufficient to look up the names of these objects in a Chinese dictionary, for it will be found that a great

many of these complex terms (ideographs and pictographs) contain the symbol for bamboo. This fact signifies that even before their names were first reduced to writing, bamboo was employed in the making of the devices themselves. It is perhaps sufficient for our purpose to mention a few of them: Traps, weirs, sluices, barriers, poles for hook-and-line fishing, spears, sea anchors, floats, trays and poles for drying fish and baskets for transporting them, netting needles, poles for drying nets, punting poles, and scaff or dip nets, including karojals and salambas. The dredges, punting poles, sieves, and sea anchors of Oriental clam-dredging equipment are all made of bamboo.

BAMBOO IN THE EXPORT TRADE OF ORIENTAL COUNTRIES

Bamboos and bamboo products are exported from China, Japan, and Burma in important quantities. Today, much of the bamboo trade of China is carried on with neighboring countries.

Western countries draw upon the Orient chiefly for ordinary bamboo poles, Tonkin cane, split bamboo, and bamboo shoots. In the exportation of bamboo poles for use in their natural state as fishing rods, etc., Japan leads by a wide margin. All or nearly all of these poles come from species of *Phyllostachys*.

Tsinglee cane, also called Tonkin cane (*Arundinaria amabilis*), falls in a distinct category. As far as our present knowledge goes, it is produced exclusively in a small area in the hinterland of Canton, in southeastern China, and under the earlier regime practically the entire production was shipped abroad, principally to England, Germany, and the United States. Several special processes are involved in the preparation of the culms for export. The culms of this bamboo have so many splendid qualities and meet such important technical specifications that they are greatly in demand. The larger canes are extensively used, particularly in Great Britain and the United States, in the making of various articles for sports, for example, split-bamboo fishing rods, and vaulting poles. Medium-sized canes, under an inch in diameter, are used for making skiing staffs, garden stakes, handles for collecting nets, etc., while the smaller sizes go into flower stakes, pennant sticks, etc.

India formerly exported, principally to England, considerable quantities of Calcutta cane (?*Dendrocalamus strictus*), from which split-bamboo fishing rods were made originally. Since the discovery of the superiority of Tonkin cane for this purpose, however, the exportation of Calcutta cane has dwindled to almost nothing. Burma exports important quantities of the culms of a bamboo of undetermined botanical identity, known in the trade as Burma Cane. They are much used in this country, in the natural state, for surf rods.

Southeastern China is the chief source of split bamboo, the principal use of which in Western countries is the making of coarse brooms for street cleaners. It is also used to a limited extent in handcraft classes as a material for weaving. This product comes principally from *Bambusa textilis*.

Edible bamboo shoots are exported from China and Japan chiefly to adjacent countries. While the exportation of this commodity to Western countries has been small in total volume, it reaches a wide geographical area, and the growing taste of Western peoples for Oriental food is increasing the demand. This augmented demand is being met, at least in part, by the canned product. It is probable that the raw shoots exported have consisted almost exclusively of the dormant winter shoots of *Phyllostachys pubescens*. The canned shoots from Japan and central China also come from this species, while those from southeastern China are supplied by *Sinocalamus beecheyanus* and *S. latiflorus*. It appears that small quantities of dried shoots of *Bambusa sinospinosa* and the *Henon* bamboo, a form of *Phyllostachys nigra*, are exported from southeastern China to nearby countries. It is estimated by Chinese restaurateurs in the United States that the annual importation of bamboo shoots in cans or tubs currently amounts to about one million dollars. They come principally from Japan, Hong Kong, and Formosa.

BAMBOO IN TRANSPORTATION

Some idea of the importance and the extent of the use of bamboo in Oriental transportation may be conveyed by the following random list of adjuncts and appurtenances: Rafts, punting poles, tug and tracking cables, stay ropes, anchor ropes, sail covers, hoists, landing stages (both floating and fixed), fathoming poles, bilge pumps, carrying poles, baskets of various design, tung-oil buckets, pig and chicken crates, tally sticks, matting, yokes and beds for oxcarts (pl. 6, fig. 2). Calking material is commonly made of shredded bamboo (prepared by scraping the culms) imbedded in a putty composed of lime and tung oil.

BAMBOO ON THE ORIENTAL FARM

The Oriental farmer may or may not have his own grove of bamboos for the production of shoots to be eaten or culms to be fashioned according to his various needs. In any case, whether he grows his own materials or buys them elsewhere, bamboo is an important factor in his daily life.

Perhaps in no other Oriental industry does bamboo play a more varied role of usefulness than it does in agriculture. In fact, so many bamboo tools and devices are used on the farm and in the

garden, as well as in the household itself, that it is not feasible to discuss them all in the present paper.

Certain bamboo articles are indispensable to almost every kind of farm work. There is hardly a single activity which does not involve, sooner or later, directly or indirectly, the use of baskets or trays. In many areas bamboo carrying poles are an inseparable adjunct to the use of baskets, whenever there is something to be moved from place to place. In the culture and harvesting of field crops the following bamboo devices and appurtenances come into play at one time or another: Fences, irrigation wheels and irrigation pipe, well sweeps, handles for hoes, rice-cultivating rakes and other tools, flails (pl. 7, fig. 2) and threshing boards, and demountable grain bins made of narrow strips of bamboo matting erected in a spiral.

The hill tribes of Hainan, the Philippine Islands, and the adjacent mainland of Asia harvest their rice in short "hands" made up of the heads plus a 6- or 8-inch portion of the stalk. These "hands" are cured on a long narrow rack consisting of a row of posts set firmly in the ground with slender bamboo culms bound to them in a horizontal position at close intervals, and to a height of about 6 feet. The "hands" of rice are thrust between these bars in close order and allowed to remain there until they are thoroughly cured before being removed to the granaries. A narrow thatched roof protects them from rain. In the threshing, winnowing, and transportation of the grain, bamboo baskets, trays, and scoops are all-important.

Wherever the crops are of such a nature as to require protection from the depredations of wild creatures, not to mention domesticated carabao, pigs, and chickens, bamboo fencing comes into play. As for the birds, against which fences are of no avail, scarecrows of infinite variety are fashioned more or less exclusively out of bamboo.

Against insect enemies fruit growers bring bamboo spray guns into play. In the citrus groves of southern China where a certain species of predaceous red ant is colonized on the trees to keep down parasitic scales and other insects, bamboo poles serve as a means of intertree transit for the ants. As the harvest begins to mature, bamboo poles serve as supports for overladen branches. And when the fruit is ripe, it may be removed from the tree by means of bamboo poles equipped in various ways. When twigs of choice trees are in-arched, small potted stock plants are held in place within the tree by long bamboo stakes.

The care, protection, and control of livestock utilizes bamboo fences and shelters, feeding troughs and rearing crates, and leading staffs for vicious bulls. The duckherd always carries a long-handled, soft-lashed, bamboo whip with which he gently chastizes the laggards.

In Oriental vegetable and flower gardens we find bamboo poles for supporting the vines of beans and melons, and smaller stakes for other

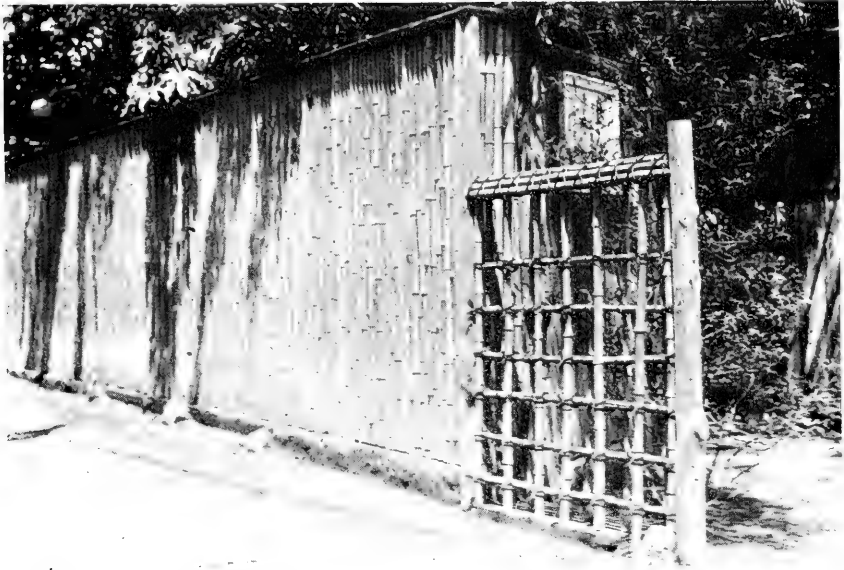

1. Garden fence at Shibuyii, Japan. As a graceful living plant, or as a screen, lattice, or archway, bamboo enhances the beauty of any scene.

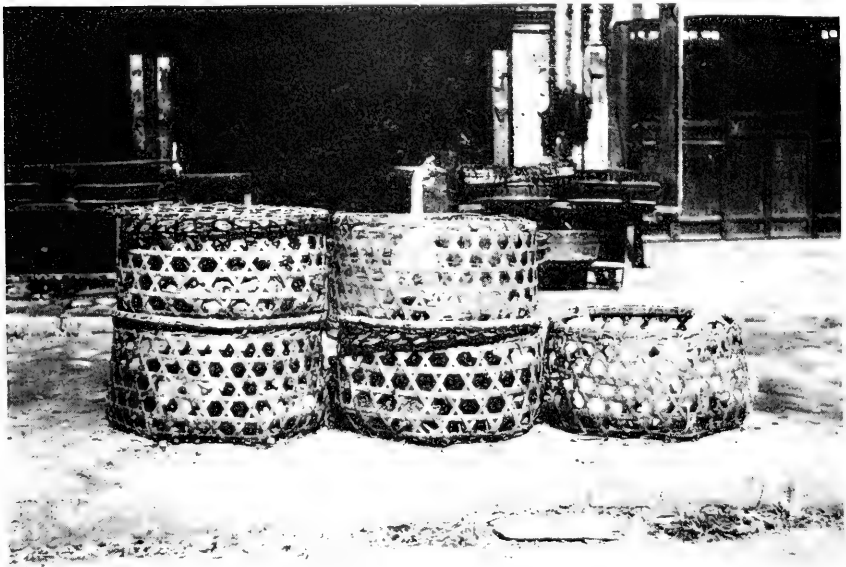

2. Stoutly built of resilient bamboo, these poultry crates are light, airy, and durable. Easily handled by porters, they may be stacked sky-high without danger of shifting or toppling. Peking, China. (Photographs by P. H. Dorsett, from the U. S. Department of Agriculture.)

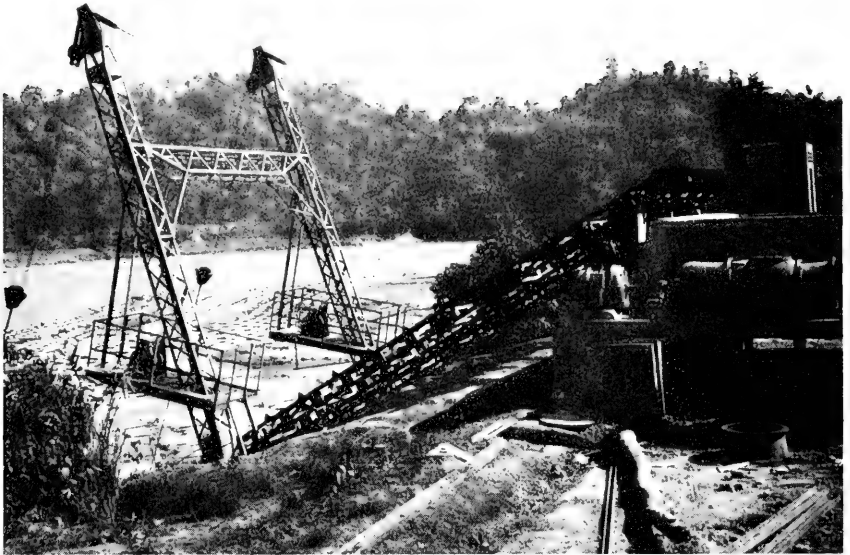

1. At the recently completed Karnaphuli Paper Mill, East Pakistan, bamboo will be used to produce 100 tons of pulp per day. Equipment shown was specially designed to lift rafted bundles of bamboo from the river to the flume, by way of which they will reach the mill.



2. Although the bamboo withes from which they are made appear frail and inconsequential, these baskets effectively stabilize a footbridge of field stones near Kao-dien, Hupeh Province, China. (Photograph by F. N. Meyer, from the U. S. Department of Agriculture.)

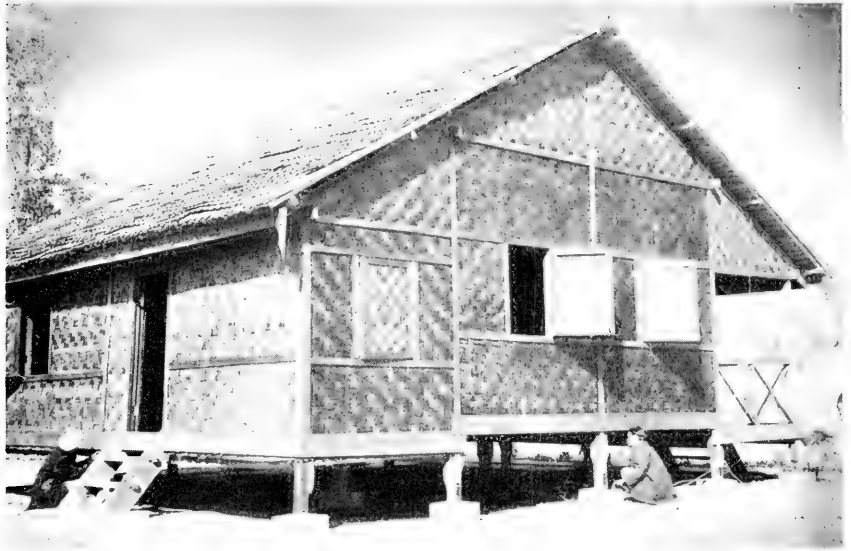

1. Hardwood-framed house with walls of bamboo matting and roof of bamboo shingles (*Bambusa polymorpha*). A modern adaptation developed in Burma.



2. The muli bamboo (*Melocanna baccifera*) is the principal material used for housing and industrial purposes in East Pakistan. Millions of culms of this bamboo come into Chittagong each year by raft.



1. As demonstrated by this bamboo worker at Chittagong, East Pakistan, who is making lashings to take the place of nails, no complicated or costly machinery is required to process bamboo for building purposes.



2. Aged cooper making bamboo hoopstock at Oimachi, Japan. The versatility of bamboo is explored by the skill and ingenuity of the craftsman in adapting his simple tools to the processing the culms. (Photograph by P. H. Dorsett, from the U. S. Department

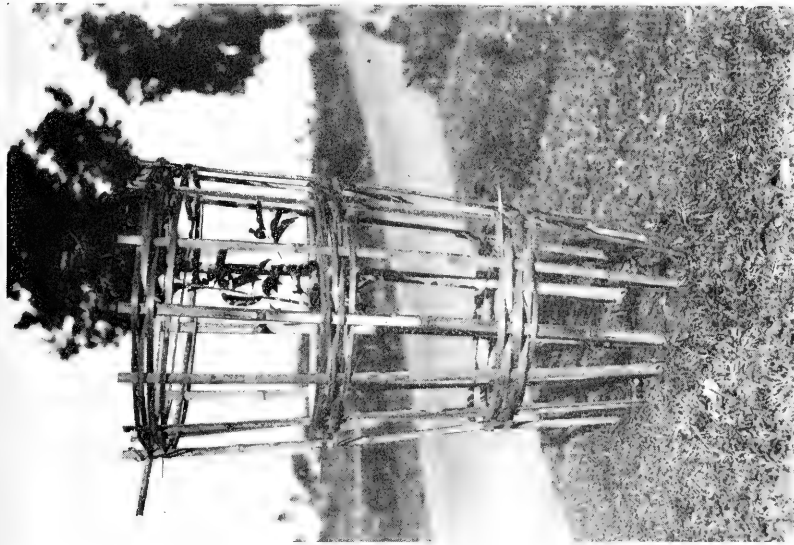

1. Bamboo guards a precious young tree inexpensively and effectively at the Bogor Botanic Garden, Indonesia.

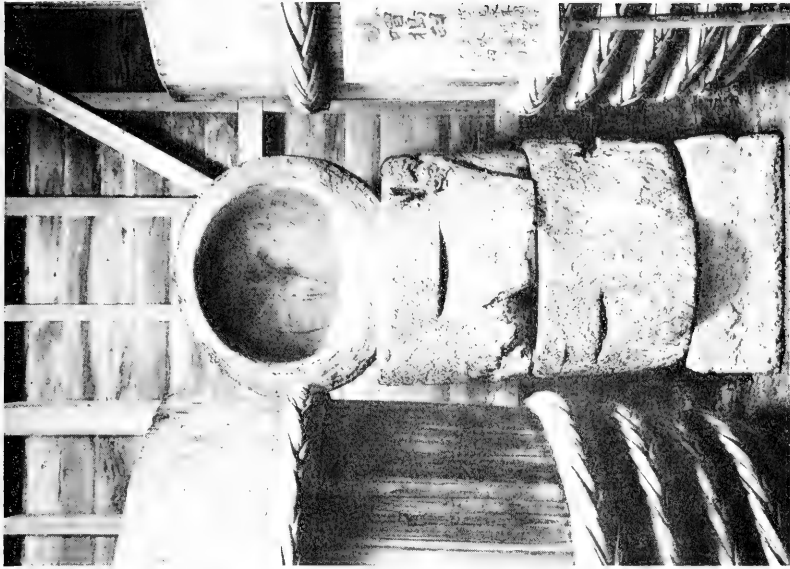

2. In the Far East massive and ingeniously contrived ligatures of bamboo add beauty as well as strength to wooden casks and tubs. Tokyo.

(Photographs by P. H. Dorsett, from the U. S. Department of Agriculture.)



1. Where traffic is light, a costly bridge would be no great improvement over this simple bamboo cable. With the aid of a sturdy hardwood clip, it uses the force of the current to propel the heavily laden ferryboat to and fro across the Siku River on the border of Tibet. (Photograph by F. N. Meyer, from the U. S. Department of Agriculture.)



2. Bamboo provides the yoke and the "bed" for ox carts, the principal means of transporting building materials in India, Pakistan, and many other parts of the Far East.

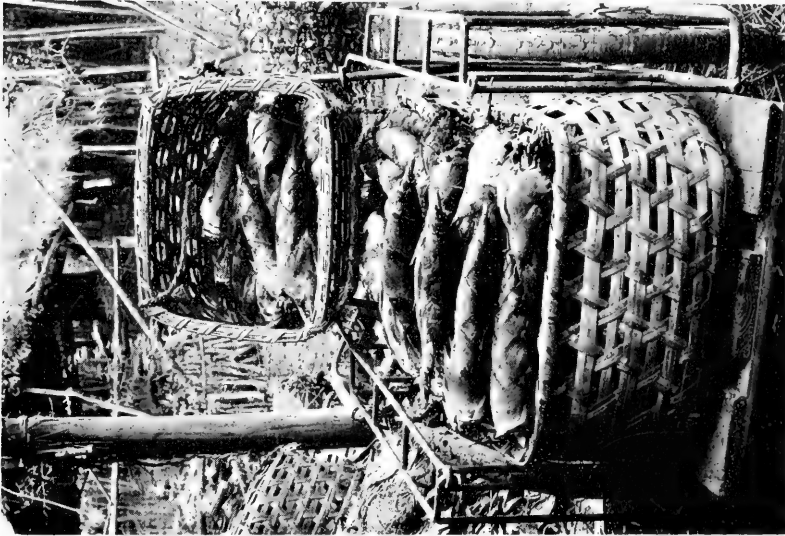

1. Bamboo shoots (*Phyllostachys pubescens*) are taken to market in bamboo baskets of light but sturdy construction. The rectangular shape favored in Japan makes for economy in packing the shoots and in accommodating the baskets.



2. Flexible and resilient bamboo, grown on the place, provides the Oriental farmer the wherewithal to make his own threshing machine. Obihiro, Japan.

(Photographs by P. H. Dorsett, from the U. S. Department of Agriculture.)



In the culture of *Sinocalamus becheyanus* and other clump bamboos for their edible shoots, the base of the plant is renovated each year in December or January; earth is heaped up afresh around it, and fertilizer is applied. Shoots are produced from July to September. Canton, China.



The garden of Sankichi Ishida, near Tokyo, Japan. Japanese bamboo gardens are admirably managed. The exacting procedures for spacing the culms and harvesting the edible shoots require care, skill, and experience. (Photograph by P. H. Dorsett, from the U. S. Department of Agriculture.)

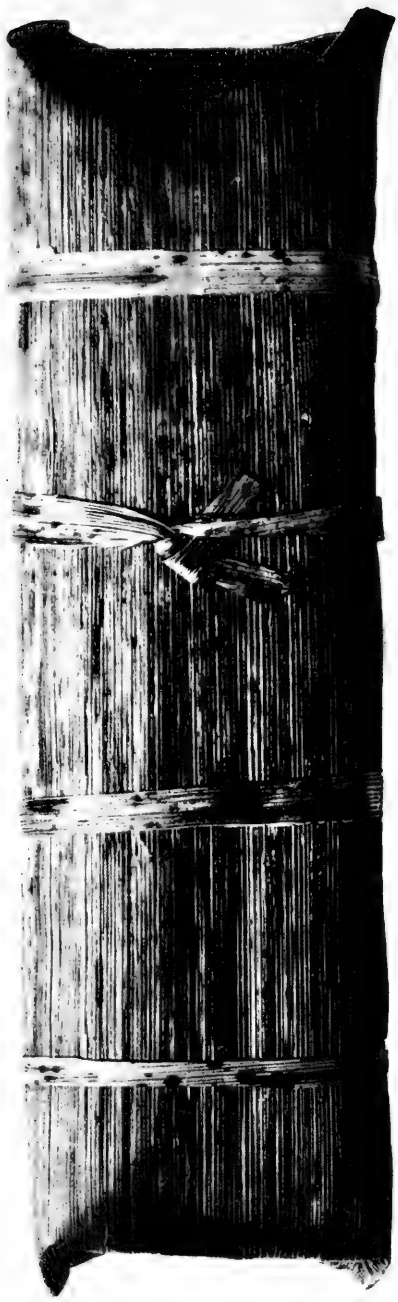

小
鯛
三越食料品部

This Japanese lunch, "ready to go," acquires a special attractiveness from the crisp texture and harmonious beige and russet-brown coloring of the bamboo culm sheath wrapping. (Photograph by P. H. Dorsett, from the U. S. Department of Agriculture.)

weak-stemmed plants. The sprinkling buckets are equipped with bamboo spouts. Windbreaks are often used as a protection against unseasonable blasts from the north, and, for certain delicate plants, bamboo sun screens are sometimes erected.

Within the household are found, in addition to the various articles of furniture, bamboo brooms, rakes for gathering fuel, fire-blowing tubes, laundry poles, chopsticks, serving trays, colanders, sieves, graters, etc. It is a common practice among the more primitive peoples of the Orient to use sections of large bamboo culms as water buckets and for storing oil and other liquids or for conveying them from place to place.

BAMBOO AS A FARM CROP IN THE ORIENT

The rural culture of bamboo in the Far East varies in its nature all the way from the intensive and detailed husbandry (pl. 9) characteristic of Oriental agriculture and horticulture, in general, to a casual treatment in which the plants are practically allowed to shift for themselves after they have been set out. The bamboos grown as a farm crop may be classified, roughly, into three groups: those grown for their edible shoots alone, those grown for both shoots and mature culms, and those grown for the mature culms only.

There are two general types of cultural practice, corresponding to the two types of rhizome growth. Bamboos of the clump type (those that have sympodial or determinate rhizomes), such as species of *Bambusa*, *Dendrocalamus*, *Schizostachyum*, and *Lingnania*, are cultivated by preference on level land, since the shallow rhizomes of this type of bamboo sometimes are at a certain disadvantage in hillside culture. Even when grown on level land, many of these bamboos thrive best when some fresh earth is thrown over the rhizomes each year. In the culture of this type bamboo for shoots (*Sinocalamus beecheyanus* and *S. latiflorus*), as carried on in southeastern China, the earth is pulled away from the base of each clump every year in December or January and the dead wood of old rhizomes is removed. The earth is then heaped up afresh and the systematic application of fertilizer, usually diluted urine, is begun (pl. 8). In addition to protecting the rhizomes and roots from undue exposure and drying, these heaps of earth serve to protect the young shoots from the light until they are large enough to be harvested. This is important, for the action of sunlight spoils their flavor.

Bamboos of the spreading type (pl. 9) with slender, indeterminate rhizomes, such as species of *Arundinaria* and *Phyllostachys*, are grown on both level land and hillsides. Aside from the question of fertility, which is usually higher in level land, hill land seems to be preferred by bamboos of this type. This may be due in part to their abhorrence of poor drainage. It may be, also, that the slope of the land affords

a certain stimulus which would explain the use by the rhizomes of a greater vertical range of the soil strata, a condition evident in hillside cultures. This postpones the competition between rhizomes which soon becomes apparent in plants grown on level land.

Culture of bamboo exhibits a great range of care. One extreme is represented by complete neglect of the grove other than harvesting the shoots at the appropriate time or cutting the culms when they are mature. One degree of improvement comes with selection of those shoots that are to be allowed to reach maturity, and the intelligent choice of culms to remove, looking to the maintenance or increase of the productivity of the grove. A further improvement is represented by removal of weeds and bush from the grove once a year. When the careful farmer sees that the soil has become choked with an accumulation of old rhizomes, he renovates the grove or shifts its location.

In addition to being grown as a farm crop, bamboo is extensively used throughout the Orient to form living hedges, barriers, and wind-breaks. While these are usually informal, they are sometimes trimmed and restricted rather systematically. Bamboos of the clump type are preferred for these purposes in areas where they are sufficiently hardy. Unlike bamboos of the running type, they form rather compact tufts, spread slowly, and do not encroach upon adjacent land. For small, formal or informal, ornamental hedges in tropical and subtropical areas, varieties of *Bambusa multiplex* are generally used. In more temperate regions dwarf species of *Phyllostachys*, *Sasa*, or some of the other related genera are employed. For the protective barriers about villages so commonly seen in the more tropical parts of the Orient, large spiny-branched bamboos of the genus *Bambusa* are employed. The shoots of *Bambusa sinospinosa* and *B. blumeana* are edible after parboiling. In China the former are usually dried for consumption during the winter season. The latter are used to a very great extent as an esculent in the Philippine Islands.

BAMBOO IN THE PREVENTION OF EROSION

Although the potentialities of bamboo as a means of preventing erosion on steep slopes have never been fully exploited in the Orient, the plant has been consciously used to excellent advantage for this purpose on levees and dikes. Bamboo groves of the spreading type on mountain sides incidentally serve this very important function to a much greater extent than is generally realized.

USES OF BAMBOO CULM SHEATHS

Bamboo culm sheaths are husklike structures which completely clothe and protect the young culm or shoot. The base of each sheath is attached to the culm at a node. In most bamboos the sheath falls

away from each successive node, beginning at the basal ones, as soon as the internode stops its growth in length; in some the sheaths persist and gradually disintegrate in place.

The culm sheaths of certain species of bamboo, particularly of the genera *Bambusa*, *Dendrocalamus*, and *Phyllostachys*, have special characteristics in respect to size, texture, toughness, and flexibility, which suit them for various purposes. The flexible sheaths of several of the larger species of *Phyllostachys*, for example, are commonly employed, in both China and Japan, as covers for earthenware jars in which certain food products are stored. Other foods are regularly wrapped in these flexible sheaths for display and retail disposal (pl. 10). In Japan, slender strips of this same type of sheath are widely used in place of twine and in nurseries as a substitute for raffia. They are moistened to increase their toughness while being tied.

In southern China the sheaths of a large thorny species (*Bambusa sinospinosa*) are torn into narrow strips to serve as the web of coarse sandals. Here also woven-bamboo casks lined with the broad, stiff sheaths of *Sinocalamus latiflorus* are commonly employed for transporting incense powder. In central China the sheaths of the larger species of *Phyllostachys* are used to line these incense casks and to serve as a protecting cover for bales of the cheaper grades of paper. In various localities in the Orient, bamboo culm sheaths are employed as a waterproof and sunproof lining for inexpensive hats.

In Oriental hand printing and block-print making, the paper is laid upon the inked block. A clear and uniform impression is then insured by rubbing the paper with a pad known as the "baren," a term borrowed from the Japanese. The baren has a firmness suited to the peculiar needs of the work to be done. It is basically a thin disk of wood padded with several layers of tough paper. The outer covering is always a smooth, tough, flexible bamboo sheath. In both China and Japan the baren used by printer and blockmaker is covered with a culm sheath from a large species of *Phyllostachys*, usually *P. pubescens* or *P. bambusoides*.

One often sees, in the more tropical parts of the Orient, scarecrows made from large stiff culm sheaths. The sheaths are either suspended by a short cord from the tip of a bamboo pole thrust into the ground at an oblique angle, or simply impaled upon a short stick set upright. As the sheath swings about in the breeze, the pale, polished, inner surface and the dull outer one reflect the light differentially, exaggerating the effect of its motion.

CONCLUSION

This account only begins to cover the phases of the utilization of bamboo. The conscious aim has been to present an intimate view of selected aspects in those areas of the Far East where its perfection

is most remarkable. The motive has not been to suggest that we should try to imitate the ways of the East, but rather that we should appreciate anew the genius that has given us such a rich heritage, and that we should recognize and ponder again the remarkable versatility of this group of plants.

Numerous introductions of living bamboos have been brought into the United States by private individuals and through governmental agencies. Europe has no indigenous bamboos, but introduced species are found in gardens and parks wherever the climate is sufficiently mild. We have growing in the United States more than 100 species and varieties, representing nearly every part of the globe where bamboo is found. And yet, though the first introductions probably were made nearly a century ago, and though bamboos are highly esteemed and cherished in many individual collections, no species has yet established itself securely and indispensably in a single major phase of our economy.

When we know more about the technical characteristics of the different kinds of bamboo and their peculiar adaptabilities to specific industrial purposes, we shall be in a position to avail ourselves more fully of the immense potentialities of this group of plants. Since we live in the age of machines and of large-scale production, we shall need to adapt modern techniques developed in the West and mechanize old ones long employed in the handicrafts of the Orient, before we can succeed in introducing bamboo into our industrial economy to any important extent. Meanwhile we should continue to search for and introduce outstanding bamboos for trial and study.

REFERENCES

BHARGAVA, M. P.

1946. Bamboo for pulp and paper manufacture. *Indian Forest Bull.* 129, 25 pp.

BROWN, W. H., and FISCHER, A. F.

1920. In Brown, W. H. (ed.), *Minor products of Philippine forests*. Philippine Islands Dept. Agr. and Nat. Res., Bur. For. Bull. 22, vol. 1, pp. 249-310, illustr.

BURKILL, I. H.

1935. *Dictionary of the economic products of the Malay Peninsula*. 2 vols.

COHEN, W. E.

1947. Utilization of bamboo in Japan. *Australian Commonwealth Sci. and Ind. Res. Organ., Div. For. Prod.*, 8 pp. (Mimeographed.)

DEOGUN, P. N.

1937. Silviculture and management of the bamboo *Dendrocalamus strictus* Nees. *Indian For. Rec.*, n. s., *Silviculture*, vol. 2, pp. 75-173, illustr.

ESPINOZA, J. C.

1930. Testing, bending and compressive strength of the common Philippine bamboo (*Bambusa spinosa* Roxb.). *Philippine Journ. Sci.*, vol. 41, pp. 121-135, illustr.

FAIRCHILD, D. G.

1930. Exploring for plants. Illustr.
 1938. The world was my garden. Illustr.
 1943. The garden islands of the Great East. Illustr.
 1947. The world grows round my door. Illustr.

GAMBLE, J. S.

1922. Manual of Indian timbers, 2d ed.

GOUBOU, PIERRE.

1936. Les paysans du Delta Tonkinois. École Franç. Extrême-Orient Publ. 27, 640 pp. illustr.

HEYNE, K.

1950. De nuttige planten van Indonesie. 3d ed., vol. 1, pp. 285-293.

KURZ, S.

1876. Bamboo and its uses. Indian Forester, vol. 1, pp. 219-269, 335-362, illustr.

LEON, A. J. DE.

1956. Studies on the use of interwoven thin bamboo strips as stress-skin covering for aircraft. Philippine Journ. Sci., vol. 85, pp. 329-341, pls. 1, 2.

LIMAYE, V. D.

1943. Bamboo nails. Their manufacture and holding power. Indian For. Rec., n. s., Utilization, vol 3, No. 3, pp. 1-12, illustr.
 1952. Strength of bamboo (*Dendrocalamus strictus*). Indian Forester, vol. 78, pp. 558-565, illustr.

McCLURE, F. A.

1927. The native paper industry in Kwangtung. Lingnan Sci. Journ., vol. 5, pp. 255-264, illustr.
 1930. Tung oil in the Yangtze Valley. Lingnan Sci. Journ., vol. 9, pp. 233-250, illustr.
 1931. Studies of Chinese bamboos. I. A new species of *Arundinaria* from southern China. Pt. 2. Lingnan Sci. Journ., vol. 10, pp. 295-305, illustr.
 1935. Bamboo—a taxonomic problem and an economic opportunity. Sci. Month., vol. 41, pp. 193-204, illustr.
 1938. Some preliminary tests on the longitudinal crushing strength of hua-mei chu, a variety of *Bambusa tuldooides*. Lingnan Sci. Journ., vol. 17, pp. 9-15, illustr. (This bamboo was later described as *Bambusa pervariabilis* McClure.)
 1954. Bamboo utilization in eastern Pakistan. U. S. For. Oper. Admin. Mission to Pakistan. 14 pp. Karachi. (Mimeographed.)
 1956. Bamboo culture in the South Pacific. South Pacific Comm. Quart., Bull. 6, pp. 38-40.

MEYER, H. F., and EKLUND, B.

1923. Tests of the mechanical properties of bamboo. Eng. Soc. China, vol. 22, pp. 3-31.

MORSE, EDWARD S.

1886. Japanese homes and their surroundings. Illustr.

PORTERFIELD, W. M.

1933. Bamboo the universal provider. Sci. Month., vol. 36, pp. 176-183.

RAFTT, WILLIAM.

1925. Summary of investigations on bamboos and grasses for paper pulp. Indian For. Rec., vol. 11, pp. 271-281.
1950. The digestion of grasses and bamboo for paper-making. (Reprint of 1931 ed.)

WATT, GEORGE.

1908. Commercial products of India. 1,189 pp.

YOUNG, R. A.

1954. Flavor qualities of some edible oriental bamboos. Econ. Bot., vol. 8, pp. 377-386, illustr.

Reprints of the various articles in this Report may be obtained, as long as the supply lasts, on request addressed to the Editorial and Publications Division, Smithsonian Institution, Washington 25, D. C.

Mechanizing the Cotton Harvest¹

By JAMES H. STREET

*Associate Professor of Economics
University College, Rutgers University*

[With two plates]

DURING the 1935 crop season nearly $3\frac{1}{4}$ million bales of cotton, or about one-fourth of the American crop, were harvested by machine. In California, where mechanization is farthest advanced, machines gathered two-thirds of the crop. Yet a scant decade before, the amount of cotton that was mechanically harvested was negligible.

Behind this revolutionary change, which is still proceeding, lies a century of intermittent efforts to mechanize the crop, most of them doomed to failure. Cotton has long been one of our most labor-requiring farm enterprises, and the annual gathering of the crop has been an extremely burdensome and underpaid form of human drudgery. The need to preserve a large low-wage labor force for this purpose has been one of the roots of social difficulty in the South. Why did it take so long to apply the familiar technique of labor-saving invention to this vast regional enterprise?

The question involves many considerations, but it is the purpose of this paper to review only the technological aspect of the problem. The history of inventions designed to mechanize the cotton harvest is a peculiarly fascinating one because of the great variety of approaches tried out at one time or another, and the truly formidable technical, economic, and social obstacles which had to be overcome in order to find solutions.

THE NATURE OF THE PROBLEM

Cotton, unlike the small grains whose simple characteristics permitted mechanization much earlier, is a distressingly difficult crop to harvest by a uniform mechanical method. The crop is grown under a considerable diversity of soil and climatic conditions, and the resultant plant varies from a scrubby knee-high bush to a rank, wide-

¹ Reprinted by permission from *Agricultural History*, vol. 31, No. 1, 1957.

branching plant taller than a man's head. As many as 500 varieties of American upland cotton have been grown in this country simultaneously, with great variation in plant conformation, hairiness of leaf, tightness of boll, and other characteristics which seriously affect the ease of harvesting.

Much of the value of the fiber depends on its freedom from leaf trash, staining by foliage sap, and tangling with weeds. This factor, together with the waste entailed when the fully exposed fleece is readily knocked to the ground, makes picking a delicate operation. Perhaps the most troublesome aspect of the plant is that its bolls do not ripen uniformly and the crop therefore cannot be gathered at once. Unripe bolls are likely to be injured by any crude mechanical device used to harvest the early crop. These were some of the technical factors with which would-be inventors of successful cotton harvesters had to contend.

INVENTIONS TO HARVEST THE CROP

Even under the conditions of slavery some efforts were made to reduce the amount of hand labor in cotton production. As early as 1820 an imaginative Louisiana planter imported a cargo of Brazilian monkeys with the hope of training them to pick cotton.² Had they proved sufficiently adaptable it is conceivable that monkey breeding might have replaced the slave trade and thus averted critical events leading to the Civil War.

The first recorded invention of a machine to harvest cotton was a mule-drawn picker patented by Samuel S. Rembert and Jedediah Prescott, of Memphis, in 1850.³ This machine embraced two sets of rotating cylinders and disks studded with teeth to comb the cotton off the plants. Although it may be considered a simple prototype of the modern spindle picker, it was too crude to do an effective job.

By 1864 there were 12 patents in effect on a variety of manual or mechanical picking aids, and in nearly every succeeding year at least one patent has been granted for some type of harvesting device.⁴ Over 1,800 patents had been granted on new or improved models by the end of World War II, when a commercial market for these machines first began to develop. Broadly grouped, these inventions have in-

² Page, Arthur W., A cotton harvester at last, *World's Work*, vol. 21, pp. 13, 748-760, December 1910. This article is chiefly devoted to a description of Angus Campbell's spindle picker, discussed below.

³ Arts and manufactures, Rep. U. S. Commissioner of Patents for 1850, Pt. 1, pp. 233-234.

⁴ See Watkins, J. L., *King Cotton: A historical and statistical review, 1790-1908*, pp. 149, 175, 259, 1908, for descriptions of some of the earliest inventions.

cluded pneumatic extractors, electrical devices, threshers, chemical processes, strippers, and spindle pickers.⁵

UNSUCCESSFUL FORERUNNERS

Beginning with a patent issued in 1859, some of the most persistent efforts were directed toward the perfection of various types of pneumatic extractors intended to remove the lint from the boll either by suction or by a blast of air. The machines usually consisted of a vacuum tank mounted on a cart, with flexible hoses applied to the individual bolls by a crew of operators.⁶ The chief technical problem was to design a nozzle that would suck (or blow) the tight-fitting locks of cotton from the burr and convey it to a bag. A small amount of cotton was actually picked with a machine of this type in the Imperial Valley of California during a labor crisis in 1918.

During the twenties the International Harvester Co. made an extensive investigation of both the suction and airblast methods of extraction. Company engineers concluded that a crew of skilled hand pickers could easily outdistance a similar crew working with suction tubes because the unaided human hand is more dextrous than any extractive device which must be applied separately to each boll. They thereafter directed their efforts toward the complete elimination of the manual element from the picking process.

Efforts by others to devise a successful pneumatic picker continued well into the thirties.⁷ W. C. Durant, the automobile manufacturer, produced a light gasoline-powered machine weighing only three hundred pounds which employed a set of rotary blades, as well as suction, in the picker-heads. His firm in St. Louis built some 500 of these machines, but was unable to dispose of them in this country and in time sold most of them to the Soviet Government, which during the thirties displayed an active interest in mechanical cotton harvesting.

Some experimenters sought an electrical solution. As early as 1868 a Brooklyn inventor patented a device to detach the fiber from the boll by electrical attraction and to convey it, by means of a statically

⁵ Smith, H. P., et al., *The mechanical harvesting of cotton*, Texas Agr. Exp. Stat. Bull. 452, August 1932, contains illustrations of many of the early devices and a list of patents granted on all types of cotton-harvesting equipment from 1850 to 1932.

⁶ An improved cotton picker, *Sci. Amer.*, vol. 67, p. 291, November 5, 1892; Dale, William, A machine for picking cotton, *Sci. Amer.*, vol. 94, pp. 371-372, May 5, 1906; Cotton picking by suction, *Lit. Dig.*, vol. 78, p. 29, August 4, 1923.

⁷ New mechanical cotton picker, *Lit. Dig.*, vol. 103, p. 32, November 16, 1929; Straus, Robert K., Enter the cotton picker, *Harper's*, vol. 173, p. 389, September 1936; McHugh, F. D., Machines pick cotton, but—, *Sci. Amer.*, vol. 159, pp. 242-245, November 1938.

charged belt, to a receiving box. Others later tried to apply the same principle, all without success, since an electrical charge proved insufficient to pull the cotton from the boll.

A different application of electricity was that of L. C. Stuckenberg of Memphis, a diligent investigator who announced in 1922 that after 14 years of work he had successfully combined a vacuum machine with a set of electrically operated brushes revolving inwardly at the end of each suction tube.⁸ The operation of the brushes was said to have suggested itself to Stuckenberg one day when he observed a cow that had broken into a cotton field adroitly extract the fiber with her horny tongue in order to obtain the tasty oil seeds. His picking apparatus was mounted on a gasoline tractor that provided power for eight electric motors required to drive four sets of picking brushes and four suction and cleaning fans. This rather elaborate machine was also doomed to failure, since the electrically operated brushes added little to its performance, and more especially because the machine had the same disadvantage as other pneumatic machines—it did not result in a sufficient saving of hand labor. Stuckenberg spent a good many more years trying to simplify and improve his machine, to no avail.

The idea occurred to a number of inventors, possibly suggested by the successful harvester-thresher combines used in other crops, to construct a machine that would cut the entire cotton stalk and separate the lint from the rest of the plant by threshing action. Such a machine would necessarily have to be rather large and complicated in order to handle the massive bulk of the cotton plant along with the lint. A machine of this type was patented in 1886, but its performance was evidently not remarkable enough to record. In 1925 the International Harvester Co. experimented with a machine patterned after a grain separator. It was designed to pull the entire boll off the plant and separate out the cotton. It was soon abandoned because it took the mature and immature bolls indiscriminately and did not separate the lint effectively.

Proposals to utilize the entire cotton plant by some process of chemical digestion, thus obviating the need to extract the lint from the boll, were made recurrently. Robert R. Roberts, of Washington, D. C., who pioneered in the development of delinted seed, in 1906 announced that the cotton stalk could be pulped and made into paper. Since this would have greatly reduced the value of the product, there was little interest in the suggestion.⁹

Probably the most extensive experiments along this line were made by Dr. Frank K. Cameron, of the University of North Carolina, who

⁸ The successful cotton picker, *Sci. Amer.*, vol. 126, p. 179, March 1922.

⁹ Utilization of the entire cotton plant, *Sci. Amer.*, vol. 95, p. 343, November 10, 1906.

sought to substitute the entire cotton plant for wood pulp as a basic source of cellulose in the manufacture of rayon.¹⁰ He recommended that the cotton plants be thickly sown, mown, and baled by machine like hay, and then dried and powdered. The oil contained in the seeds was to be removed by the use of a solvent, and the remainder of the plant chemically digested into alpha cellulose. After a number of years of experimentation Dr. Cameron claimed that his process was a laboratory success. Coming during the depression years, the announcement caused alarm among farmers who feared a radical change in methods of production. The need for a substitute for wood pulp was evidently not pressing enough, however, to insure funds for development and the method thus did not become commercially practicable.

STRIPPING MACHINES

Cotton strippers, also known in some of their early forms as cotton sleds or "sledders," remove the cotton, burr and all, from the stalk by combing the plant either with extended teeth or by drawing it between stationary slots, revolving rolls, or brushes. A patent for a rather simple invention of this kind was granted to John Hughes of New Bern, N. C., in 1871. The following year Z. B. Sims of Bonham, Tex., patented a sled with projecting fingers for the same purpose.

A somewhat more complicated and skillfully constructed model appeared in 1874, when W. H. Pedrick, of Richmond, Ind., patented a stripper which employed two revolving rolls studded with teeth to pull the ripe cotton from the plants. Despite the fact that these machines closely resembled in principle some that later came into use, they were long neglected because it was felt that they wasted too much cotton and lowered its grade excessively.

The idea of mechanically stripping cotton was reintroduced into the Texas Panhandle in 1914, when a bumper crop coincided with prices so low that the cost of hand picking could not be covered. Several farmers in desperation harvested their cotton by dragging it with a section of ordinary picket fence tied to a team. This makeshift method resulted in cotton so full of trash and unopened bolls that it was refused at the gin. Thereupon these farmers, undaunted, took their cotton to a grain thresher and had it threshed! The threshing process broke open the unripe bolls and removed some of the trash, after which it was possible for the gin to handle it more satisfactorily.

¹⁰ Cotton mown like hay and chemically digested, *Science*, n. s., vol. 83, p. 10, May 22, 1936; Macormac, Alfred R., Utilization of the whole cotton plant, *Sci. Month.*, vol. 43, pp. 285-286, September 1936; *Scientia omnia vincit: Experiments in turning the whole cotton plant into rayon*, *Sci. Amer.*, vol. 163, p. 243, November 1940.

At best the resulting product must have been of rather low grade, and stripping for some time thereafter was utilized only as a last resort.

Nevertheless, because the cotton grown in this area is subject to early frost and was often pulled or snapped in the boll by hand, growers demanded that the ginners develop methods of handling immature or "bollie" cotton. Consequently gins were redesigned to include more effective cleaning and burr-extracting devices than were found in most parts of the Cotton Belt.

In 1926 there was another critical season in the High Plains. The crop was unusually large, prices fell abruptly, labor for hand harvesting was scarce and expensive, and the weather was unfavorable for picking by hand. Farmers were again compelled to take unusual measures to save the crop. Many of them built their own sleds, employing a variety of original designs with the assistance of the local blacksmiths; and cotton stripping received its first extensive trial. By this time the improved gins were able to process the cotton, and it was reported that the mechanically stripped cotton actually produced a better sample than cotton that was hand stripped because the additional handling before it reached the gin removed much of the dirt.

As a result of the extensive use of homemade contrivances in the Lubbock area during the 1926 season, several implement manufacturers became interested in developing cotton-stripping machines and the following year a number of commercial strippers appeared on the market. Deere and Co., the leading firm, began in 1930 to manufacture both mule-drawn and tractor-mounted strippers and two years later had increased its output to 500 units per year.

Following the onset of the depression, however, interest in mechanical strippers languished on the part of farmers and manufacturers alike. With cotton selling at 6 cents a pound, wages for hand snapping at 30 cents per hundredweight, and cash extremely scarce, the market for labor-saving devices disappeared. The John Deere strippers were offered at \$185 each on a contract calling for \$25 on delivery and the balance at \$5 for each bale harvested. Even so dealers eventually disposed of their remaining stock in 1941 at \$15 each.¹¹

In the meantime experimentation in stripper design was continued by the Texas Agricultural Experiment Station at College Station and at the Lubbock (High Plains) substation. Between 1927 and 1930 experiment station engineers worked out and tested the design for an improved stripper which incorporated a burr extractor to

¹¹ Neighbour, L. B., *Progress in the mechanical stripping of cotton*, Summary Proc. 2d Ann. Beltwide Cotton Mechanization Conf.; reprinted in *Acco Press*, vol. 26, pp. 8-9, November 1948.

clean the cotton as it was harvested.¹² This machine importantly influenced the design of most of the commercial strippers that were later built.

When labor shortages began to occur in the High Plains during World War II, farmers lost no time in adopting mechanical strippers. Deere and Co., which had sold practically no strippers from 1932 to 1942, was at last able to capitalize on its previous developmental work and became the chief supplier with an output of about 4,400 machines from 1946 to 1948. The contrast with depression conditions is indicated by the fact that in the latter year the company sold its machines at a delivered price of \$905, exclusive of tractor. Several other manufacturers turned out machines in smaller quantities, and by 1955 it was estimated that there were over 23,000 strippers available for use on southwestern farms (see table 1). Some of the newer strippers employ revolving fiber brushes instead of a metal stripper roll, following a design developed by the Oklahoma Agricultural Experiment Station in cooperation with the United States Department of Agriculture.¹³

Although cotton strippers have been tested in nearly all portions of the Cotton Belt, to date their effective use has been confined largely to the High Plains and Rolling Plains of Texas, Oklahoma, and New Mexico, where they seem best adapted to harvesting the type of cotton grown under the rather exceptional climatic conditions prevailing in those areas. About one-fifth of the Texas and Oklahoma crops were harvested by strippers in 1955 (see table 1).

SPINDLE PICKERS

Inventions in this group have included a multiplicity of cotton harvesters designed to pick the open cotton from the bolls by means of spindles, fingers, or prongs. The aim has been to construct a machine that could be used for repeated pickings during the season without material injury to the unopened bolls and the foliage necessary for continued growth. However, from the time of Rembert and Prescott's early invention in 1850 until the nineties very little progress was made in developing such a machine. About this time Angus Campbell, a Scottish patternmaker employed by the Deering Harvester Co., began to work out the essential mechanical principles for a machine that would pass a series of rotating spindles through a cotton plant and twist the loose fiber from the bolls. He started work in 1885 and took out his first patent in 1895.

¹² Smith, H. P., et al., Mechanical harvesting of cotton as affected by varietal characteristics and other factors, Texas Agr. Exp. Stat. Bull. 580, December 1939.

¹³ Oates, W. J.; Witt, R. H.; and Wood, W. S., The development of a brush-type cotton harvester, Agr. Eng., vol. 33, pp. 135-136, 142, March 1952.

TABLE 1.—*Estimated number and percentage of mechanical cotton harvesters on farms, and percentage of cotton mechanically harvested, by States, 1955-56 season*

| | Spindle pickers ¹ | | Strippers ¹ | | Percentage of cotton harvested by machine ² | |
|-------------------|------------------------------|------------------|------------------------|------------------|--|------------------|
| | Number | Percent | Number | Percent | Picked | Stripped |
| Southeast: | | | | | | |
| Alabama..... | 198 | 1 | 41 | (⁴) | 2 | (⁴) |
| Georgia..... | 260 | 1 | (³) | ----- | 3 | (⁴) |
| N. Carolina..... | 65 | (⁴) | (³) | ----- | 2 | ----- |
| S. Carolina..... | 300 | 2 | (³) | ----- | 2 | ----- |
| Midsouth: | | | | | | |
| Arkansas..... | 2,600 | 14 | 63 | (⁴) | 25 | (⁴) |
| Louisiana..... | 1,035 | 6 | (³) | ----- | 28 | ----- |
| Mississippi..... | 2,600 | 14 | (³) | ----- | 23 | ----- |
| Missouri..... | 1,345 | 7 | (³) | ----- | 24 | ----- |
| Tennessee..... | 255 | 1 | (³) | ----- | 2 | ----- |
| Southwest: | | | | | | |
| Oklahoma..... | 39 | (⁴) | 2,805 | 12 | (⁴) | 20 |
| Texas..... | 1,547 | 9 | 19,524 | 85 | 3 | 21 |
| West: | | | | | | |
| Arizona..... | 2,100 | 11 | ----- | ----- | 39 | ----- |
| California..... | 6,000 | 32 | ----- | ----- | 67 | ----- |
| New Mexico..... | 300 | 2 | 689 | 3 | 16 | 4 |
| Total..... | 18,644 | 100 | 23,122 | 100 | ⁵ 17 | ⁵ 6 |

¹ Estimates compiled by National Cotton Council of America, Memphis.

² U. S. Agricultural Marketing Service, Charges for ginning cotton, costs of selected services incident to marketing, and related information, season 1955-56 (mimeographed), May 1956, p. 2.

³ Estimate either not requested or insignificant number reported.

⁴ Less than 0.5 percent.

⁵ Percentage of total United States crop harvested by respective method.

Campbell showed great persistence and personal sacrifice in his efforts to perfect his machine over a period of 37 years.¹⁴ Each harvest season for over 20 years he used his vacation time to journey from his place of employment in Chicago to Texas, Louisiana, or Mississippi, where he would try out his latest model. In 1910, after trying out some 55 designs, he was so confident of success that he put five machines into the field in a widely publicized demonstration at Waxahatchie, Tex. Evidently his optimism was premature, since few farmers bought machines.

The same year Campbell joined forces with Theodore H. Price, who had independently devised a cotton harvester which he patented

¹⁴ For contemporary accounts of Campbell's activities, see Page, *op. cit.*, pp. 13, 748-760; Day, William, Picking cotton by machine, *Sci. Amer.*, vol. 104, p. 231, March 4, 1911; A machine that is philanthropist, *Outlook*, vol. 97, pp. 484-485, March 4, 1911.

in 1904. The Price-Campbell cotton picker was patented in 1912 and underwent continuous testing and improvement until Campbell's death in 1922. The results, however, were never completely satisfactory. The self-propelled machine was heavy, complicated, and expensive to build. It left too much cotton on the plant or knocked to the ground, in addition to which it injured the unripe bolls.

Notwithstanding these deficiencies, Campbell had done a valuable piece of work. The heart of his machine was an ingenious cam-actuated mechanism that positioned a battery of revolving barbed spindles in the cotton plant as the machine passed over it, and then removed the lint from the spindles by means of stationary doffers. The Price-Campbell patents were taken over by the International Harvester Co. in 1924, and although further testing and modification required another quarter-century, Campbell's basic ideas contributed importantly to the ultimate success of the first commercial cotton picker when it appeared in 1948.

Other inventors who attempted to perfect one version or another of the spindle cotton picker during the first quarter of the century included P. P. Haring of Goliad, Tex.; B. Johnson of Temple, Tex.; George R. Meyercord of Chicago; John F. Appleby (the widely known inventor of the self-knotting grain binder); and Hiram N. Berry of Greenville, Miss.¹⁵ All their machines attracted some notice at various times, but none was fully successful. Moreover, each inventor was confronted with the fact that because of the abundance of low-paid farm workers in the South, a mechanical cotton picker would have had to be overwhelmingly efficient to compete successfully with hand labor.

The longest continuous effort to devise a spindle picker was made by the International Harvester Co., which had evidenced interest in the problem from the time of its formation in 1902. Drawing on the experience of one of its predecessor companies, the Deering Harvester Co., the implement firm spent 40 years in research and an estimated \$5,250,000 before it was able to demonstrate in 1942 a spindle picker which it regarded as satisfactory for production.

Between 1924 and 1930 company engineers designed, built, and tested in the field seven distinct types of machines, beginning with an improved model of the Price-Campbell picker. They also tested literally hundreds of variations in the shape, size, and arrangement of spindles, doffers, and other essential parts. Recognizing the financial limitations of cotton growers, they sought to simplify the pon-

¹⁵ After Hiram N. Berry's death his son, Charles R. Berry, continued to make improvements on his father's self-propelled picker. In 1943 Deere and Co. bought the Berry patents and utilized them for a time in the development of its own spindle picker.

derous self-propelled picker and thus reduce its cost. The introduction of the all-purpose tractor in 1925 spurred them to devise a trail-model picker that could be attached to the tractor with a power-takeoff arrangement and that would yet leave the tractor available for other purposes on the farm.

The company believed it was ready to introduce a trial machine on a limited basis in 1929 and the parts for 20 such machines were already completed when the financial collapse of that year abruptly altered the economic outlook. In the succeeding years of deepening depression conditions became less and less propitious for the introduction of a machine that would displace labor. Experimentation went on, but as Clarence R. Hagen, chief development engineer, remarked,

Considerable opposition to mechanical picking was encountered in the field. Many cotton farmers were very skeptical, and sure that the cotton crop could not be mechanized. At the end of every harvest season we returned with a little more experience and a little more ridicule, for the average cotton grower believed firmly in the eternal supremacy of the Negro cotton picker.¹⁶

Yet it was in the midst of these depression years, when the acreage-reduction program had contributed its share of displaced farm workers to the ranks of the already unemployed, that there appeared on the scene a mechanical harvester which seemed to meet the requirements for efficiency and labor saving that would enable it to compete successfully with human labor at extremely low wages. This was the cotton picker invented by John D. Rust and developed with the assistance of his brother Mack. The advent of this machine is interesting not only as a technical achievement but for the social dilemma it posed.

As children on a Texas cotton farm John and Mack Rust had picked cotton on their knees and had often discussed the possibility of inventing a machine to ease this form of human drudgery.¹⁷ John Rust became an itinerant farm mechanic whose only formal training in engineering came from a correspondence course. While working for a combine manufacturer in Kansas City in 1924, he began to devise the principal mechanical features of his spindle cotton picker.

He was baffled, as many before had been, by the problem of removing the cotton from a spindle that was sufficiently barbed or serrated to

¹⁶ Hagen, Clarence R., Twenty-five years of cotton picker development, *Agr. Eng.*, vol. 32, p. 594, November 1951.

¹⁷ For short biographical accounts of the Rust brothers, see Straus, *op. cit.*, pp. 386-395; Rust, John, The origin and development of the cotton picker, *West Tennessee Hist. Soc. Pap.*, vol. 7, pp. 38-56, 1953; Mr. Little Ol' Rust, *Fortune*, vol. 46, pp. 150-152, December 1952; Weybright, Victor, Two men and their machine, *Surv. Graphic*, vol. 25, pp. 432-433, July 1936.



High-drum spindle cotton picker.

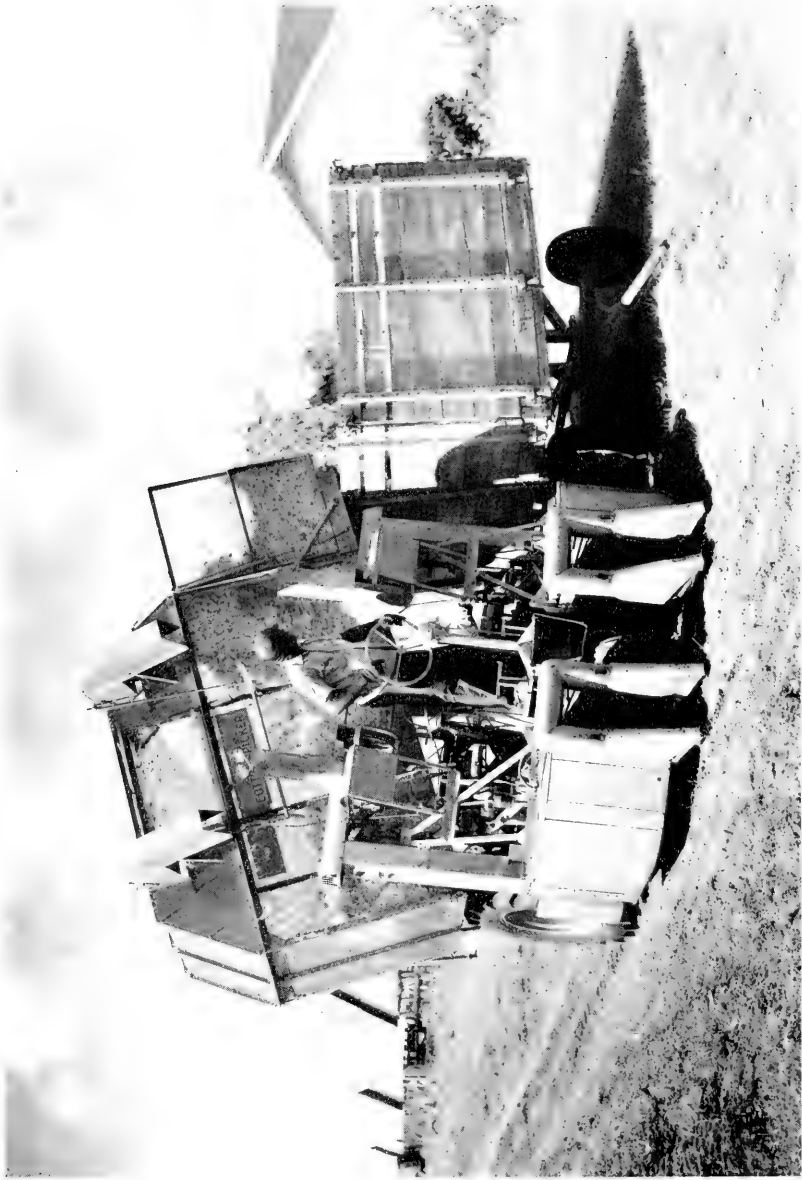

Two-row cotton picker unloading.

twist the lint from the boll. According to his own account, it was while lying in bed one night in the spring of 1927 that he remembered how the morning dew had caused the cotton to cling to his fingers when he had picked cotton as a boy. He also recalled that his grandmother had always moistened the spindle of her spinning wheel in order to get the cotton to adhere.

"I jumped out of bed," he wrote, "and found some absorbent cotton and a nail for testing. I licked the nail and twirled it in the cotton and found that it would work."¹⁸

Rust thereupon returned to Texas, where he worked out the plans for an experimental model. It differed from previous pickers chiefly in the use of moistened smooth-wire spindles instead of roughened, barbed, or twisted spindles to secure aggressive picking action. It also employed a simplified endless-belt mechanism to position the rows of spindles in the plants without raking and injuring the bolls. As the loaded spindles traveled on their circuit they were easily stripped clean by pairs of traveling steel ribbons. Although his machine subsequently underwent many modifications, the picking principle has been preserved in essentially its original form in machines based on Rust patents currently in use.

Rust's first patent was filed in January 1928, and his first test model was completed that year. He was joined by his brother Mack, who had been employed in Schenectady as an electrical engineer, and together they embarked upon a series of trials and improvements. Although they had many discouragements with the performance of the early models and their financial backing remained meager, they aroused the interest of a number of supporters who shared the humanitarian outlook the Rust brothers were attempting to apply in the introduction of their invention.

The Rust harvester set a record when it picked a bale of cotton in one day during a test conducted at Waco, Tex., in 1931. Two years later an improved model picked five bales in a single day at the Delta Experiment Station at Stoneville, Miss. These tests received little publicity, however, and it was not until the publication of an article in national magazines in early 1935 that the invention and its social implications became the subject of intense public discussion.¹⁹ Another public field trial was held under the auspices of the Delta Experiment Station on August 31, 1936. This time, under rather favorable conditions, the machine picked at the rate of four-fifths

¹⁸ Rust, *op. cit.*, p. 15.

¹⁹ Carlson, Oliver, The revolution in cotton, *Amer. Mercury*, vol. 34, pp. 129-136, February 1935; reprinted in condensed form in *Reader's Digest*, vol. 26, pp. 13-16, March 1935.

of a bale an hour—40 to 50 times the average rate for hand picking. There was considerable trash added to the lint and waste in the rows, but there was no doubt that the machine would pick cotton. The demonstration was widely reported in the national press, for it appeared to show conclusively the labor-saving potentialities of the picker and thereby to cast an ominous shadow on future employment prospects in the region.²⁰

The Rust brothers were now faced with a perplexing set of problems. They were eager to see their machine put to use, but they did not wish to be responsible for encouraging the trend toward large-scale mechanized farming at the expense of small farm owners and sharecroppers. They were afraid widespread labor displacement would result if the sale of their machine were unrestricted.

For a time they refused to sell their shop-produced machines outright, but offered to lease them to farm operators who would agree to maintain minimum wages and maximum working hours on their farms, and who would give up the use of child labor. Few planters were willing to provide such guarantees in return for the doubtful advantages of mechanical harvesting.

The Rust brothers also encouraged the trial of their machines on various types of cooperative farms which sprang up during the depression, but the need to save labor was rarely the chief problem in these ventures. Hoping to make their picker available to small farmers, the inventors spent several years trying to devise a "Universal Pull Model" that could be drawn by a mule or a small tractor. These efforts proved to be technically impracticable.

In 1937 the Rust brothers abandoned their leasing plan and announced that they would sell their 2-row, self-propelled machines on the open market for \$4,800. At the same time they declared that they would restrict their share in the returns to an amount not to exceed 10 times that of their lowest paid employee. A foundation was to be set up to apply any remaining personal profits to the assistance of displaced farmers and to promote cooperative farming. Nevertheless, the requisite capital was not forthcoming, and under the stringent conditions of World War II the shop tools had to be sold off to meet the company's debts. John and Mack Rust parted company at this time. Mack Rust went west with a few demonstration models to establish a custom picking business on the irrigated farms of Arizona and California.

²⁰ Cotton picker portents, *Business Week*, No. 366, p. 15, September 5, 1936; Cotton-gin rival: Rust cotton picker, *Lit. Dig.*, vol. 122, pp. 45-46, September 5, 1936; Rust brothers' cotton picker, *News Week*, vol. 8, p. 29, September 5, 1936; Picker problems, *Time*, vol. 28, pp. 47-48, 50, September 14, 1936.

In addition to his financial difficulties, John Rust had reached the dispiriting conclusion that his machine as it then existed lacked sufficient durability for general sale. Working models, while they would pick cotton when kept in continuous repair, tended to break down in the field when critical parts became worn. Under the encouragement of his wife, and with the requirements of mass production in view, he sat down to redesign the entire machine from the drafting board.

THE INTRODUCTION OF THE COMMERCIAL PICKER

It was at about this time that the long efforts of the International Harvester Co. to develop a commercially satisfactory picker came to fruition. Under the direction of A. W. Scarratt and C. R. Hagen the machine was radically redesigned to be mounted on a powerful high-clearance tractor with higher picking units to accommodate rank irrigated cotton. The tractor itself was operated backward to permit the picking units to contact the plant before other parts of the machine could knock the cotton from the bolls. The machine incorporated 600 tapered, slightly barbed spindles, and had a moistening device to aid in picking and doffing.

The enormous departure of labor from southern farms during the war years led to increasing reports of labor shortages and for the first time opened the way for serious consideration of labor-saving machinery in the cotton region. To meet the emergency, Fowler McCormick, president of the International Harvester Co., announced in 1942 that his company regarded its cotton picker as practicable for use and offered to begin production if materials allocations could be made. Wartime priorities rendered this temporarily impossible, but the announcement spurred other manufacturers to get into the race to produce the first commercial cotton picker.²¹

Deere and Co. acquired the Berry patents at this time, and the Allis-Chalmers Manufacturing Co. negotiated an agreement with John Rust to construct machines incorporating his new designs on a nonexclusive basis. In the confused postwar adjustment period, however, none of the companies was able to get into quantity production. There was still considerable doubt that cotton growers were ready to accept complicated, expensive machines to harvest their crop when labor was drifting back to the farms. It was increasingly clear that an important secondary bottleneck—the hand labor needed for weed-

²¹ Cotton harvester: International Harvester's machine, *Newsweek*, vol. 20, p. 68, December 7, 1942; Six-bale picker, *Business Week*, No. 743, pp. 69-70, 72, November 27, 1943; Race for pickers, *Business Week*, No. 748, pp. 61-62, January 1, 1944.

ing and thinning—would also have to be eliminated before growers could rely on a completely mechanized crop.

In the face of these uncertainties, the International Harvester Co. under the leadership of R. P. Messenger, an executive vice president, proceeded with the construction of a new plant in Memphis. In 1948 this plant turned out over 1,100 machines, priced at \$7,600 when mounted on a large model-M tractor. Professor Gilbert C. Fite commented, "This is an astronomical sum for over half of the cotton growers who produce less than four bales of cotton a year and farm less than thirty acres of cropland."²²

Nevertheless, a commercial market for the machines was developing among the larger growers and custom operators. By 1952 the International Harvester plant had produced more than 8,000 machines, including both high- and low-drum models. In 1956 it added a new 2-row picker, also available in sizes suited to different growths of cotton. In the meantime the Allis-Chalmers Co. acquired a new plant at Gadsden, Ala., and turned out 1,200 pickers between 1949 and 1952. These included a 2-row machine and a small single-unit attachment that was priced under \$2,500 (exclusive of tractor) to bring it within the reach of a greatly increased number of users.

During the same period Deere and Co. produced about 750 1- and 2-row pickers, and a new entrant to the field, Ben Pearson, Inc., at Pine Bluff, Ark., built 1,500 1- and 2-row machines based on Rust patents. In addition, this company is now constructing picking attachments which are mounted on the respective tractors of the J. I. Case Co. and Massey-Harris-Ferguson, Inc., and the assembled machines are being marketed by those companies. Versions of Rust cotton pickers are thus being sold by four companies. Until his death in 1954 John Rust continued to make improvements in his invention, and he was at last able to realize his goal of an educational and charitable foundation financed by patent royalties.

The growing acceptance of the cotton harvester as a successful farm tool, although it has not yet been widely adopted in some portions of the Cotton Belt, is clearly indicated in table 1. It is estimated that over 18,000 spindle pickers and 23,000 strippers were available for the 1955-56 harvest, most of them concentrated in the western cotton States and the Mississippi Valley. In other areas the predominantly small farms, broken terrain, and relative abundance of hand labor still pose obstacles, but research is under way to adapt the machines for more effective use under such conditions.

²² Fite, Gilbert C., Recent progress in the mechanization of cotton production in the United States, *Agr. Hist.*, vol. 24, pp. 19-28, January 1950.

The introduction of mechanical harvesting has been vastly facilitated by a large variety of complementary inventions and techniques which have emerged in the past few years, and which have been promoted by the National Cotton Council through its annual beltwide mechanization conferences. The weeding and thinning problem is being met by the application of pre- and post-emergence chemical herbicides, flame weeders, and newly designed mechanical choppers and cultivators. Plant breeders are developing varieties suited to mechanical harvesting. Chemical defoliant is used to remove the leaves before harvest, and improved ginning machinery aids in preserving clean, high-quality lint. Taken together, these advances constitute a technological revolution, the profound consequences of which are only beginning to be appreciated.

Reprints of the various articles in this Report may be obtained, as long as the supply lasts, on request addressed to the Editorial and Publications Division, Smithsonian Institution, Washington 25, D. C.

Aniline Dyes—Their Impact on Biology and Medicine¹

By MORRIS C. LEIKIND

*Medical Historian and Archivist
Armed Forces Institute of Pathology*

THE YEAR 1956 marked a centennial significant not only in the history of chemistry and chemical technology, but in the history of biology and medicine as well. It was just 100 years ago that an English schoolboy, aged 18, made the first aniline dye.

The repercussions of this discovery were felt in the fields of chemistry and chemical technology, in the textile industry and in fashion salons, and also in agriculture, in coal mines, in banks and counting-houses, in legislative halls, and in the foreign offices of governments. Last but not least, the coal-tar dyes had an impact on biology and medicine that was as unexpected as it was significant.

Before reviewing the influence of aniline dyes upon the growth and development of the life sciences during the past hundred years, it seems not only appropriate but even necessary to recall briefly the life and work of William Henry Perkin. Although he has been dead scarcely half a century, few among the present generation of biologists and medical men know who he was, and fewer of the many who use biological stains and administer wonder drugs know anything of the man who made them possible.

William Henry Perkin was born in London on March 12, 1838. He was the youngest son of George Fowler Perkin, a builder and contractor of moderate means. William's education began in a private school. His father wanted him to become an architect, a wish encouraged by the fact that the boy liked to draw and often copied plans for his parent.

¹ Read at the Perkin Centennial, 1856-1956, commemorating the discovery of aniline dyes, held at the Waldorf-Astoria Hotel, New York City, during the week of September 10, 1956. Sponsored by the American Association of Textile Chemists and Colorists.

However, shortly after his twelfth birthday, William found a friend who showed him some chemical experiments and as a result he acquired a keen interest in chemistry. He was fascinated by chemical reactions and especially by the beautiful forms of crystals and decided that if it were at all possible he would become a chemist. By the time he was 13 he was accumulating bottles of chemicals and performing experiments at home. Just about this time he was sent to the City of London School, one of the very few schools in England where science was taught. Even there, however, instruction in science was informal, for it had no place in the regular curriculum. The educated man was marked by his knowledge of the classics rather than of science and "stinks" was the name reserved for chemistry.

The man who taught science at this school was a Mr. Thomas Hall who had been a pupil of the great chemist, August Wilhelm Hofmann. Hall's teaching of science was informal and was a sideline to his regular and full schedule of conventional classical subjects. Twice a week during the dinner hour science instruction was more or less "sneaked in," and it was in this way that young Perkin obtained his first systematic knowledge of chemistry. His assiduity attracted the attention of his teacher, who invited the boy to become his laboratory assistant. William found chemistry so interesting that he skipped many meals in order to have time for experiments. When he was 14 his instructor suggested that he write to Michael Faraday, then lecturing at the Royal Institution, for permission to attend the lectures. Faraday graciously consented and sent a ticket that admitted the youth to the Saturday afternoon sessions.

By this time Hall felt that his pupil was ready for more advanced studies and urged him to enter the Royal College of Chemistry. The boy's father objected since he still wanted his son to become an architect and he could see no prospects for a decent living in chemistry. In the course of several personal visits to the elder Perkin, Hall obtained parental permission for the boy to choose his own career. Thus at the age of 15 he enrolled for study under Hofmann, a student of Liebig, who, during 20 years as director of the Royal College of Chemistry, trained the leading British chemists of the Victorian Era. William Crookes, of Crookes' tube fame, was an assistant in the College and he gave the new student his first task—that of studying the reactions of metals. Perkin soon completed the ordinary course of analysis but was not content to become a mere analyst. He wanted to do research, and it was not long before he attracted the attention of Hofmann himself who was then investigating the production of organic bases from hydrocarbons by the reduction of nitroderivatives. He gave Perkin the job of trying this method on anthracene. The first problem was to extract this substance from coal-tar pitch, but

it ended in failure since, with laboratory quantities, the yield was insignificant. Larger amounts of pure anthracene were finally obtained from a tar distillery and Perkin tried to nitrate this. Again he failed. As a matter of fact, it was 25 years before the problem was finally solved. Nevertheless, Perkin did, without realizing it then, produce anthraquinone by the action of nitric acid on anthracene. Anthraquinone happens to be the parent substance of alizarin, the red dyeing principle of madder, which Perkin later had a hand in synthesizing.

Despite these failures, Perkin had now learned a great deal of chemistry, and Hofmann made him his assistant. Hofmann was himself a most enthusiastic and stimulating teacher, and through him Perkin was able to meet most of the scientific leaders of Britain and the Continent when they visited the Royal College of Chemistry. Thus by the age of 18 he already had a vast knowledge of contemporary chemistry and a mature insight into its problems. Since Perkin's duties at the College left him little time for independent research he fitted up a small laboratory at home where he could work evenings and during vacation. It was there that he made his first great discovery.

Hofmann, in the annual report of his laboratory for the year 1849, had suggested that the time was ripe for an attempt to synthesize quinine. This drug, it will be recalled, is the principal alkaloid of cinchona, the bark of the cinchona tree, native to certain areas of South America. It has long been used for the treatment of fevers, especially of malaria. For centuries the drug was used simply in the form of the powdered bark of the tree or as an extract or infusion. Then in 1820 Pelletier and Caventou of France succeeded in isolating quinine from the bark as an alkaloid in which form it gained an increased popularity as a drug. At the same time chemists became interested in synthesizing this compound, but without success. Nevertheless Professor Hofmann felt that the state of chemical knowledge of the mid-nineteenth century justified another attempt at the synthesis of quinine. In 1849 he wrote:

It is a remarkable fact that naphthalene, the beautiful hydrocarbon of which immense quantities are annually produced in the manufacture of coal gas, when subjected to a series of chemical processes may be converted into a crystalline alkaloid. This substance, which has received the name of naphthilidine, contains 20 equivalents of carbon, 9 equivalents of hydrogen and 1 equivalent of nitrogen. Now if we take 20 equivalents of carbon, 11 equivalents of hydrogen, 1 equivalent of nitrogen and 2 equivalents of oxygen as the composition of quinine, it will be obvious that naphthilidine, differing only by the elements of 2 equivalents of water, might pass into the former alkaloid simply by the assumption of water. We cannot, of course, expect to induce the water to enter merely by placing it in contact, but a happy experiment may attain this end, by the discovery of an appropriate metamorphic process.

We know now, of course, that his reasoning was wrong, based as it was upon an incomplete knowledge of chemical structure.

Nevertheless, it was this "happy experiment" which Perkin in his eighteenth year attempted to perform in his home laboratory during the Easter vacation of 1856. He began with toluidine, a coal-tar derivative, which he treated with allyl-iodide, getting allyl-toluidine which was converted into a salt and precipitated with potassium dichromate. A dirty reddish-brown substance was the result, but it was not quinine. This did not discourage Perkin. He found the reaction interesting and he thought that a clue to the synthesis of quinine might be found by using the same procedure on a simpler base. He therefore chose aniline. He treated aniline sulfate with potassium bichromate and now he got a black precipitate. But again, it was not quinine.

At this point many investigators would have become discouraged and quit. In fact, it is often stated, without much foundation in fact, that Perkin did get discouraged and dumped his residue into the sink whereupon a purple color appeared. This makes a good legend but is not borne out by the facts. For Perkin did not throw his residue into the sink. He decided to take a second look. He began to investigate the nature of the precipitate, and what he found was most interesting. When this black precipitate was purified and dried and then digested with spirits of wine, it gave a brilliant purple solution. Then came an act of genius. Perkin immersed a piece of silk in this colored solution and found that his aniline purple was a dye.

Perkin put the quinine problem aside and concentrated on a study of the coloring matter. When he returned to the Royal College of Chemistry he showed the new substance to one of his colleagues who strongly urged him to patent it. But Perkin was hesitant. He doubted the practical value of the dye because it appeared difficult to make on a large scale. Nevertheless, he did send a sample of dyed silk to a textile firm and received a most enthusiastic response, with a reservation, of course, about price. The new coloring matter was found to be not only attractive but also faster than any similar color available. This latter quality was highly important to textile manufacturers. So fugitive were the contemporary purples that if a lady put a violet ribbon on her hat in the morning she could never be sure that it would retain its color till evening.

Encouraged by the reception of his first samples, Perkin continued his pilot experiments, and by August 1856 he was sufficiently sure of his results to obtain a patent. He now decided to leave the College to become an industrial chemist. As he later wrote about this episode:

Although the results were not so encouraging as could be wished, I was persuaded of the importance of the colouring matter, and the result was that, in

October, I sought an interview with my old master Hofmann and told him of the discovery of this dye, showing him patterns dyed with it, at the same time saying that as I was going to undertake its manufacture, I was sorry that I should have to leave the Royal College of Chemistry. At this he appeared annoyed, and spoke in a very discouraging manner, making me feel that perhaps I might be taking a false step which might ruin my future prospects.

But this youngster of 18 was not deterred. Although he antagonized his professor by deserting pure science for a commercial gamble, he succeeded in persuading his own hard-headed father to invest his life savings in this enterprise. His elder brother, who already had a promising business as a builder, was also induced to join the firm. In 1857 a small factory was started at Harrow and a new industry was about to be born. The beginning was not easy. Besides purely chemical problems which had to be solved, there were chemical engineering problems as well. Much of the apparatus needed for large-scale manufacture of dyes did not exist and had to be invented. Yet within 6 months after the factory was opened, Perkin, not yet 20, was selling aniline dyes. Within 2 years aniline purple was being made in France where it gained the name "mauve," and soon the color was so fashionable it was made the subject of music-hall jokes. (*Punch* reported that a Frenchman who visited London returned and told his friends that even the policemen there were ordering people to "get a mauve on.") When Queen Victoria wore a silk dress dyed with aniline purple, the rage for mauve was really on. In 1859, the French paid tribute to the importance of this discovery by awarding a medal to Perkin. It was the first of many similar honors paid to him. Within a relatively few years he was manufacturing eight coal-tar colors, seven of them by processes originating in his own works. These included mauve, Britannia violet, Perkin's green, and alizarin, all of which were made on a large scale. Alizarin, which Perkin developed independently of Graebe and Liebermann in 1869 (the Germans beat Perkin to the patent office by one day), was of the greatest economic importance. Natural alizarin, or turkey red, was an ancient dyestuff obtained from the fleshy part of the root of the madder plant (*Rubia tinctorum* and *R. perigrina*). It was known to the ancient Egyptians, and it has been identified as one of the dyes used to color some of the robes worn by King Tut. It was introduced into England in the eighteenth century by way of India, the Levant, and France. The demand for this coloring matter was great and thousands of acres were devoted to raising the plants from which the dye was produced. Madder, incidentally, was one of the earliest dyes used in microscopy, as we shall see shortly. Then in one fell chemical stroke an immense agricultural industry was wiped out. Within a very few years after the synthesis of alizarin, some 400,000 acres in France and

elsewhere, which had been producing the madder plant, had been converted to the growing of food crops. A few years later the synthesis of indigo forced the elimination of another agricultural product.

By 1874 Perkin felt that he had had enough of chemical technology. He therefore sold out his interests for about 100,000 pounds and retired to devote himself to pure research. His later work included the synthesis of coumarin, an odoriferous substance with the smell of new-mown hay. With this discovery he laid the basis for the synthetic perfume industry. He also studied the formation of unsaturated fatty acids and did considerable fundamental work on the subject of magnetic rotation.

Perkin married twice and had three sons and four daughters. The sons all became chemists, and the eldest, William Henry Perkin, Jr., became one of England's greatest organic chemists. The elder Perkin received many honors during his lifetime. He was elected a Fellow of the Royal Society in 1866, named a Royal Medallist in 1879, and was awarded the Davy Medal in 1889. In 1906 the Jubilee of the Discovery of Mauve was celebrated in both England and America. In 1907, shortly before his death, Perkin was knighted by his king.

We turn now to a consideration of the effect of the discovery of aniline dyes on biology and medicine. This is in fact one of the most instructive episodes in the history of science, since it illustrates so beautifully the unexpected way in which a discovery in one field of science may profoundly influence developments in other areas. In 1856 when the first aniline dyes were made no one could have anticipated that within a few years a whole family of coloring agents derived from coal tar would be of assistance in solving many fundamental problems in cellular biology and pathology and would play a major role in the discovery of the causes and cures of many infectious diseases.

To appreciate the full significance of the discovery of aniline dyes on the biological and medical sciences let us glance quickly at the status of knowledge in these subjects a century or more ago.

The way in which aniline dyes exerted their influence on biology and medicine was first of all as an aid to the microscope. These dyes were discovered at a moment when they could be effectively used to help solve certain important problems for biologists and medical men. To appreciate this it will be useful to recapitulate very briefly a few facts about the history of the microscope and microscopy. Several periods may be distinguished. Although the microscope was invented sometime between 1590 and 1608 (the exact date is uncertain) little important scientific work was done with it at first. The first important phase from 1660-1723 was the time of the "Classical Microscopists." These included Marcello Malpighi, who discovered the

capillaries and was a pioneer in the study of the microscopic anatomy of plants and animals; Robert Hooke, who first described compartments in cork which he called cells, thus introducing this word into the language of biology. Hooke also published the first serious scientific monograph on microscopy. Another of these early workers was Jan Swammerdam, who performed incredible dissections of insects under the microscope and devised the techniques of micro-injection and micromanipulation. Perhaps the greatest of the classical microscopists was Antony van Leeuwenhoek, who first saw bacteria and protozoa, saw the blood pass through the capillaries from arteries to veins, described spermatozoa, and was also the first to use a coloring agent to stain tissue for observation under the microscope.

From the time of the death of Leeuwenhoek in 1723 to about 1830 advances in microscopy were sluggish. One reason was that microscopes were so crude and their lenses so poor that few persons were willing to take the trouble to use them. The principal defect in the lenses was chromatic aberration. By 1830, however, crown and flint glass was available, and this glass made possible the development of lenses, especially in combinations, in which chromatic aberration was eliminated. With the aid of achromatic lenses new advances were made. The microscopic structure of plants and animals began to be better understood, and in 1839 Schleiden and Schwann summarized the observations of many workers and announced the cell theory. Histology, cytology, and embryology began to emerge as sciences. Nevertheless, for technological reasons, progress was again limited. Most of this early work was done with the use of low-powered lenses and weak illumination and without the use of stains. Thus it was that in the middle of the nineteenth century, Ferdinand Cohn, professor of botany in Breslau, wrote:

As long as the makers of microscopes do not place at our disposal much higher powers, and, as far as possible, without immersion, we will find ourselves . . . in the situation of the traveller who wanders in an unknown country at the hour of twilight at the moment when the light of day no longer suffices to enable him clearly to distinguish objects, and when he is conscious that, notwithstanding all his precautions he is liable to lose his way.

Cohn's complaint was soon to be answered. The production of the substage condenser and the development of homogeneous immersion lenses (unavailable in Cohn's day) led to the tremendous improvement in the illumination of objects observed under the microscope. Simultaneously staining techniques were introduced, and they soon became indispensable in biological and medical research and in medical diagnosis.

The early history of biological staining is, as a matter of fact, still quite confused, and it is foolhardy for anyone at present to give more

than a tentative priority to any one individual because the prospects are still good that a diligent searcher may at any time unearth an obscure reference showing that someone else has antedated one's own "first."

If one investigates the early history of the subject, he can see this for himself. For a long time it was believed that Joseph von Gerlach introduced the use of stains in microscopic work in 1858. Then it was shown that Goeppert and Cohn (1849) had preceded him. They had, in fact, been antedated by Ehrenberg in 1838. Preceding all of them was the Englishman Sir John Hill, who as early as 1770 had used dyes, especially extract of logwood, to study the microscopic structure of timber. Actually, however, as mentioned earlier, it was Antony van Leeuwenhoek who was apparently the first to record the use of a dye as an aid to microscopic observation. He was attempting to study the difference between the muscle fibers of a fat cow and a lean one. To improve the visibility of the material under his lenses, he soaked some fibers in saffron, a yellow dye obtained from the crocus plant. Leeuwenhoek failed to follow up his observations, or to perfect his technique, and so it was almost two centuries before systematic efforts were made to use dyes or coloring matter as an aid to microscopic observation.

But if Joseph von Gerlach was not the undoubted originator of staining, he certainly was its most articulate promoter, and for this he definitely deserves credit. Gerlach (1820-96) was professor of physiology and then of anatomy at the University of Erlangen during most of his active life. He was a keen student of microscopic anatomy and contributed much to the development of microscopic technique. One of his greatest contributions was the discovery, independently, and partly by accident, of the staining properties of carmine, a dye obtained from the cochineal insect. He had been trying unsuccessfully to use this dye as a stain when on one occasion he inadvertently left a section of brain in a dilute solution overnight. In the morning he found a beautifully stained specimen. His previous failure had obviously been due to the use of a highly concentrated solution. He at once recognized the significance of this observation and proceeded to develop its technical consequences. Not only that, but he so enthusiastically promoted its use among his colleagues and students that despite the earlier use of carmine by others Gerlach's name was associated with the beginning of staining techniques in biology.

It was at this most opportune time that William Perkin made his epochal discovery of aniline dyes. As soon as the dyes were commercially available, it was almost inevitable that someone would try them out on a microscopic preparation. This happened in 1862 when Beneke of Marburg, about whom little is known, employed acetic acid

colored with lilac aniline. It is not certain just what dye this was in modern terminology, but it is believed to have been the same as aniline violet, aniline purple, or mauve discovered by Perkin. Beneke's announcement was made in the form of an untitled letter to the editor of a small journal and it is difficult to assess its influence. In 1863 W. Waldeyer, also a German, began to use aniline dyes for anatomical studies. He used such stains as aniline red, Paris blue, and aniline violet. Soon other workers were experimenting with the new dyes.

In the United States the first worker to use aniline dyes for the staining of pathological tissues was Joseph Janvier Woodward (1833-84), a surgeon and brevet lieutenant colonel in the United States Army. Practically all who have written on the history of stains and staining have overlooked Woodward's contribution. He was an assistant curator of the newly established Army Medical Museum in Washington, D. C., when he did his histological work. In 1864 he wrote a letter to Rudolph Virchow in Berlin, the draft of which still exists in the Medical Museum Archives, and it contains the following passage:

Have you been able to retain with any permanency the color of your carmine preparations? Have you used aniline or any of its derivatives for coloring microscopical specimens, or are you acquainted with any coloring material preferable to either?

Regrettably, Virchow's reply, if he ever answered, has not been found. During the following year, however, Woodward published a note in the *American Journal of the Medical Sciences* (vol. 49, pp. 106-113), under the title: "On the use of aniline in histological researches, with a method of investigating the histology of the human intestine, and remarks on some of the points to be observed in the study of the diseased intestine in camp fevers and diarrheas."

He began his paper with these words:

Since July 1864 I have made considerable use of aniline colors in my histological studies and they have been extensively employed in the investigations carried on under my direction for the microscopical Department of the Army Medical Museum. As the use of these colors for the purpose of staining certain parts of tissues and thus rendering them more visible appears to be unknown in this country and, so far as I can learn from the journals accessible to me, is imperfectly understood abroad, I have thought it advisable to make public the method of using them employed in the laboratory under my direction.

Woodward's first samples of dye were obtained from a Dr. Genth of Philadelphia. He used fuchsin, a reddish dye, and a blue one labeled Bleu de Lyon. He was the first American to employ aniline dyes in histological work and was probably the first anywhere to use them in pathological studies. His efforts unfortunately had little influence on the development of staining techniques in this country.

There were very few microscopes in America, and microscopists were even scarcer. Thus the principal advances were made in Germany where the dye industry was being developed at a rapid pace and where research, both academically and industrially, had already progressed from amateur to professional status.

A technical development of considerable importance came in 1869 when Boettcher and, later, Fleming (both of Germany) in 1875 developed the principle of alcoholic differentiation. By overstaining and then removing the excess dye with alcohol it was found possible to control with great accuracy the end result. It was this method of differentiation which led Fleming to develop some years later his famous triple stain. The method of producing double and triple staining effects had very important consequences in another direction to which we shall come in a moment when we consider the work of Paul Ehrlich.

In the field of biology the advent of the new dyes made possible new knowledge concerning the internal structure of cells and a better understanding of the phenomena of cell division. The stains provided the roots for such fundamental terms in cytology as chromatin and chromosomes, referring to the ability of these structures to take up dyes.

In pathology the new stains helped to improve diagnostic techniques and were invaluable tools in the solution of many problems. Thus in 1869 Julius Cohnheim of Breslau began his classical studies of inflammation, the nature of which was scarcely understood. Even Virchow had misconstrued the process since he argued that inflammation was a local cellular response manifested by cells at the site of injury. However, there were some who believed that other cells, especially white corpuscles of the blood, were also involved. In a brilliant series of experiments Cohnheim showed that this was so by tagging leucocytes with aniline blue and then following their course to the seat of an inflammatory process.

But useful as the aniline dyes were to pathology in increasing our understanding of the seats of diseases, they played an even more significant role in revealing the causes of infections and parasitic diseases and even in their cure.

One of the most important applications of the new dyes was in the field of bacteriology, then in the process of becoming a science. It will be recalled that Leeuwenhoek had first seen bacteria in 1676. He did not, however, associate these minute organisms with infectious diseases. Indeed it was 200 years after bacteria were first seen before their role in the etiology of disease was conclusively proved. There were, of course, many reasons for the delay. The solution of the problem had to wait upon improvements in the microscope, improvements

in observing techniques, and above all on the invention of methods for handling bacteria and growing them in pure culture. Practically all the early observations were made upon free-living forms as found in nature. Their role in such natural phenomena as fermentation and putrefaction was not understood at all; most workers, in fact, regarded microbes as the result of these reactions rather than the cause. These ideas implied a belief in the theory of spontaneous generation. Thus, before any real progress could be made in understanding the role of bacteria in the economy of nature, this theory had to be disproved. The story of the battle over abiogenesis is too long to recount at this time. Through the labors of many workers, especially Louis Pasteur and John Tyndall, it was finally shown beyond the shadow of a doubt that bacteria are not generated in fermenting or putrefying materials but in fact are the causes of these reactions. It was demonstrated that if proper precautions were taken to keep microbes out of such things as milk, urine, blood, grape juice, flesh, etc., no fermentation or putrefaction occurred. Furthermore, it was demonstrated that specific reactions were associated with the presence of specific micro-organisms.

Now the way was cleared for an attack on one of the oldest of human problems, the cause and prevention of infectious diseases. From time immemorial men had lived in helpless dread of plagues and epidemics. They were attributed to evil spirits, the wrath of God, or to such assumed natural causes as miasmas or noxious emanations from swampy or low-lying areas, or climatic conditions. Thus the name "malaria" (literally bad air) is a verbal fossil surviving from the days of miasmatic thinking. But from time to time some bold thinkers put forth the notion that invisible living agents might cause infectious diseases. After the discovery of bacteria, the number of these speculations increased. But no one came forth with any proof. In 1840, Jacob Henle, a German pathologist, published a small monograph in which he examined this question. He argued that the time was ripe for an experimental attack on the problem of infectious disease and pointed out that there was some very suggestive evidence indicating that microbes might in fact be the causative agents. Henle drew up a set of postulates or principles which would have to be satisfied in such a demonstration. First of all it would have to be shown that a specific organism was invariably associated with a specific disease. Second, it should be possible to separate the specific organism from the diseased body and grow it in pure culture. Third, it would have to be possible to produce the disease in susceptible animals by infecting them with this organism and then reisolating it. Twenty-five years later, Henle's brilliant pupil, Robert Koch, working in a home laboratory with homemade equipment, demonstrated the validity of these criteria (hence generally known as Koch's postulates) in anthrax, a

disease of cattle. He saw the germs of the disease in the blood of infected cattle. He was able to grow these germs outside the animal body for several generations in culture media which he devised; and when he reintroduced these germs into susceptible mice they promptly became ill and died of anthrax infection.

While Koch was carrying on these investigations, another worker, Carl Weigert, was working along a line that converged on Koch's problem. Weigert as a pathologist was concerned with methods of recognizing cellular elements under the microscope. He knew about the new dyes that were appearing from the great chemical factories in Germany. He was also aware of one of the cardinal problems in the infant science of bacteriology. This was the question of recognizing the presence of bacteria in tissues. In the unstained state they were almost impossible to distinguish from other cellular structures. Weigert tested a number of dyes, and in 1875 he was successful in demonstrating cocci in tissues by the use of methyl violet, a coal-tar stain. In 1877 he successfully stained anthrax bacilli in various organs of a dog using methyl violet, Bismarck brown, and other aniline colors. These results helped enormously in convincing skeptics that there might be something to the germ theory of disease.

Robert Koch now began to perfect methods for handling and observing bacteria, techniques without which bacteriology could not emerge as a science. He developed the solid-culture method for isolating and growing pure cultures of bacteria. Then he devised a simple method for staining bacteria outside the body tissues. In the living state, especially while in motion, microbes were almost impossible to resolve and identify under the microscope. This fact made accurate diagnosis practically hopeless, and study extremely difficult. Koch solved the problem by making very thin smears or films of bacteria from cultures, body fluids, or exudates on glass slides or cover slips. These films were fixed by gentle heat or air drying and were then stained. The organisms now stood out sharp and clear in a microscopic field without distortion or alteration of size. Koch found that of all dyes the aniline colors were best suited to bacteriological work. He further found that such stained preparations could easily be photographed. From his photographs, Koch was able to confirm the existence of flagellae in bacteria, structures about which a controversy had been raging between those who claimed they saw them and those who said they were imaginary. Within a span of about two decades, often called the golden age of bacteriology (1875-95), with the aid of pure culture techniques and staining methods devised by Koch and his school, the causative agents of many of the most important diseases afflicting man and animals were identified. These included the tubercle bacillus and

the germs of leprosy (now called Hansen's disease), cholera, typhoid fever, puerperal fever, pneumonia, glanders, diphtheria, brucellosis, malaria, tetanus, and others.

The discovery of bacterial and parasitic causes of disease led at once to attempts at prevention and cure. In the field of surgery Joseph Lister worked out the principles of antisepsis, later modified to asepsis. These were primarily techniques for keeping bacteria away from a surgical operative field by the use of antiseptics and sterilized instruments and dressings. Thus the horrors of wound infection were removed from the operating room and hospital wards. In this field also, coal-tar derivatives played a most important role in serving as a source for antiseptic agents for wound dressings and as a sterilizing medium for instruments.

But the real impact of aniline dyes in the field of therapeutics was made by the work of Paul Ehrlich, who was born in eastern Germany in 1854, just two years before Perkin made the first coal-tar dye. Like Perkin, Ehrlich was also a very young man when he made his first notable scientific contribution. While still a medical student he began to study the effect of dyes on tissues. Stimulated by the work of his teacher Julius Cohnheim and his cousin Carl Weigert, Ehrlich became interested in the chemistry of dyes and the relation of chemical structure to specific actions on cells. The coal-tar dyes very quickly attracted his attention, and he was the first to recognize the biological difference between acid and basic dyes. This led him during the years 1877 to 1880 to his epochmaking studies on blood in which he differentiated several varieties of white blood corpuscles by means of their responses to stains. These included basophiles, eosinophiles, neutrophiles, lymphocytes, and monocytes. He was the first to recognize stippling in red blood cells and described the earliest known case of aplastic anemia. Shortly after leaving medical school, Ehrlich was invited by Robert Koch to work in his laboratory in the Imperial Health Office in Berlin. He arrived there about the time that Koch was carrying on his classic researches into the cause of tuberculosis. On the day after Koch announced his discovery of the tubercle bacillus, Ehrlich devised an improved method of staining the organism with aniline dyes. Ehrlich's method is still used in every diagnostic laboratory, although it is known to generations of technicians as the Ziehl-Nielsen stain because of two minor technical modifications introduced by these workers. Ehrlich also worked out the rationale of the polychromatic staining methods which have since become so popular and useful. There are numerous modifications among which may be mentioned Unna's polychrome methylene blue, Mallory's aniline blue connective tissue stain, Romanowsky's eosin methylene blue stain for use on blood smears and for the diagnosis

of malaria. Variants of these stains are known by the names of Leishman, Giemsa, Wright, Hastings, and others.

Shortly after coming to Berlin, Ehrlich contracted tuberculosis and went to Egypt to recuperate. After 2 years, the disease arrested, he returned to Germany and began work on the standardization of antitoxic sera, especially those against diphtheria and tetanus. His studies, although directed toward a very practical purpose, produced results of the highest theoretical significance, since they led him to evolve his famous side-chain theory of immunity. It would lead us too far afield to discuss this here, but it should be mentioned that the basic concept was derived by Ehrlich from his work on the specificity of staining reactions. From the very beginning of his investigations, he had been obsessed with the idea that the basis of staining reactions was the ability of specific cells or parts of cells to fix or have an affinity for specific stains. He generalized this idea in his motto "*Corpora non agunt nisi fixata*"—bodies do not react unless they are fixed—and from this Ehrlich derived his idea for a search for a "magic bullet" or drug effective against the specific agent of specific diseases. The "magic bullet" was no mere whimsey or figure of speech. It derives from an ancient theme in Germanic folklore and in fact provides the motif in von Weber's opera, *Der Freischütz*.

With this notion, Ehrlich created the modern science of chemotherapy. He began from the observation that methylene blue seemed to have a special affinity for nerve cells. He was curious about the reason for the unique specificity. He therefore suggested to chemists, notably Caro of the Badische Anilin and Sodafabrik, that certain modifications of the dye be prepared which might provide a clue to its selective action on nervous tissue. In the course of these investigations a new coal-tar intermediate was discovered which provided the basis for synthesizing a whole new series of commercially important dyes, the rhodamine series. Here we have an example of how a purely biological research proved useful to industry and commerce. In the meantime Ehrlich had discovered that methylene blue was a very effective stain for malaria parasites. This was in 1891 and it led to some trials on patients. The results were not too promising but were not completely negative since they pointed the way later to the synthesis of some really effective antimalarial drugs. Ehrlich next attempted to find a drug effective against trypanosomes, one type of which causes African sleeping sickness. The first result was the synthesis of a tetrazo dye, trypan red. This was found to be effective against *Trypanosoma equinum*, the causative agent of mal de caderas, a disease of horses. Trypan red worked in mice infected with this organism and was the first example of a specific drug synthesized to be effective against an experimental infectious disease.

Shortly thereafter two French workers, Mesnil and Nicolle, made up two additional dyes of the same series, trypan blue and afridol violet. The trypan blue was found to be effective against a trypanosome disease of cattle. But the carcasses of cows so treated encountered sales resistance in the butcher shop. Bright blue meat did not attract customers. A search was therefore started for a colorless trypanocide. The Bayer Company, after synthesizing and testing several thousand compounds, finally developed Bayer 205 or Germanin, which was found to be very effective against African sleeping sickness—so effective, in fact, that the Germans, after World War I, offered to release the formula only in return for their last African colonial empire. Britain refused and shortly thereafter Fourneau of the Pasteur Institute in Paris successfully synthesized the drug.

Ehrlich meanwhile pressed forward with his own researches. In 1906 he was made the head of a privately endowed laboratory in Frankfurt, the George Speyer Haus, devoted exclusively to chemotherapeutic research. As early as 1902 Ehrlich had begun to study certain arsenic-containing compounds related to atoxyl. This was the first organic arsenical tried in trypanosomiasis. It was named atoxyl because at first it was thought to be nontoxic to the host. This proved not to be so. Ehrlich and his chemists attempted to modify the molecule so as to enhance its effect on the parasite while decreasing the toxicity for the host. One byproduct of this work was the production of acriflavin. This chemical, while not effective against trypanosomes, was found to have value as a wound disinfectant. In 1905 Schaudinn and Hoffmann discovered the cause of syphilis and at once Ehrlich began a hunt for a compound effective against the spirochete. Once again he tried modifications of arsenic compounds in the form of a radical hooked onto a dye molecule. In 1909, after testing compound 606 in his series, he, together with his assistant Hata of Japan, announced the discovery of salvarsan or arsphenamine as a cure for syphilis. It was Ehrlich's greatest triumph. Among many honors showered upon him was the Nobel Prize.

Ehrlich now became interested in the possibility of finding a cure for cancer. It was his last major investigation before he died in 1915. That he failed is not to his discredit since no one else has yet discovered a cure for this disorder. Yet if and when such a cure is found one may predict that it will probably be discovered along the road and by the methods so successfully charted by Paul Ehrlich.

The high hopes raised by Ehrlich's brilliant chemotherapeutic successes were not sustained after his death. For, while a number of compounds had been found which were useful in the treatment of protozoal and spirochetal diseases, no really effective magic bullets had been found against bacterial infections.

The outbreak of World War I led to a renewed search for new and better antiseptics to combat wound infections. Once again aniline dyes proved useful. It had already been observed that certain of these dyes, when incorporated into media for growing bacteria, had the ability to suppress the growth of some germs while permitting others to develop. This was a useful diagnostic tool in isolating certain bacteria from mixtures. Now it was found that some of the germs against which the dyes exerted a selective bacteriostatic action were common causes of wound infection. Gentian violet, brilliant green, and other members of the triphenylmethane series were found to be especially effective. Thus, during the war gentian violet was used with considerable success at the Walter Reed Hospital in Washington for the treatment of diphtheritic infections of amputation stumps. Another antiseptic of considerable value developed during this period and stemming directly from Ehrlich's own studies was neutral acriflavine. Mercurochrome and related substances are familiar to all. Yet despite a concerted effort in numerous laboratories all over the world, little practical progress was made in finding chemotherapeutic agents effective in the patient's body against such organisms as the pneumococcus, streptococcus, the enteric organisms. The breakthrough came in 1932-35, when Gerhard Domagk of Germany discovered the first of the sulfa drugs of which literally hundreds have been synthesized. Again these find their chemical basis in coal-tar dyes. The subsequent discovery of the antibiotics is outside the scope of this story. However, to make this account complete and, in fact, to return to the starting point, as it were, I must mention the search for antimalarial drugs. It will be recalled that Perkin discovered aniline dyes by accident while attempting to synthesize quinine. With the increase in chemical knowledge, others took up the problem where Perkin left it and this time with more success. Between World Wars I and II a series of potent antimalarial drugs such as atabrine, plasmoquine, paludrine and others were prepared. These were found to be especially effective during the Second World War when supplies of natural quinine were cut off. Then in 1944, quinine itself was synthesized by Woodward and Doering of Harvard. How Perkin would have rejoiced at this feat, for a feat it was. But synthetic quinine, while representing a scientific triumph, is not a practical drug since it is too expensive for commercial use.

In summary, we have seen how the aniline dyes discovered by William Henry Perkin came at a most fortuitous moment in the history of medicine and biology. In retrospect, it is even possible to question whether medicine and biology as we know them today could have reached their present position had they not traveled the rainbow road that poured out of Perkin's test tubes and tar buckets.

Causes and Consequences of Salt Consumption¹

By HANS KAUNITZ

Department of Pathology, Columbia University

THE ADDITION of salt (sodium chloride) to our food has been curiously taken for granted, although there seems to be little physiological evidence as to whether we are benefited by this habit. Ever since historical records have been kept, salt has played an amazingly important part in the lives of men. Wars have been fought over its sources, and for centuries its trade was more important than that of any other material, as can be seen from the word "salary." Homer called it "divine," and it has played an important part in many religious cults, in folklore and superstitions.

Although there was certainly a great deal of deep wisdom connected with the use of salt in ancient rites, it scarcely seems possible at present to appreciate the meaning of the old cults because we have as yet been unable to free ourselves from many prejudices connected with its use. In our own time, the sharpness of the discussions as to the advisability of salting one's food may still be a reflection of this tradition, which also makes it understandable that the discussions are so frequently carried on by faddists rather than nutritionists.

For these reasons and because the physician is so frequently approached with the question of whether one should use salt, an unprejudiced discussion of this subject seemed desirable. It should be stated, however, that undeniable facts, which should form the basis of this discussion, are indeed scarce. One is forced to be guided all too often by biological innuendoes and vague clinical impressions; thus the conclusions here set forth should be taken with more than a "grain of salt."

It seems particularly timely to give consideration to the problem of the action of sodium and potassium salts from a point of view other than their conventionally accepted role as regulators of osmotic pres-

¹ Reprinted by permission from *Nature*, vol. 178, pp. 1141-1144, Nov. 24, 1956. Bibliography omitted.

sure because, in the present era of cell physiology, the conclusion is inescapable that inorganic materials play an important part in hormonal and enzymatic processes. Therefore, it seems not inappropriate to discuss the role of sodium and potassium salts from this point of view, although at this time the considerations are largely of a speculative character.

Theories which lay the groundwork for our own concepts were gradually developed about 150 years ago. In a book which reveals a remarkably modern outlook, Lehmann, in 1853, came to the conclusion that the adding of salt to natural foodstuffs is unnecessary for man. This view seemed to be supported by the fact that most animals, in freedom and in captivity, do well on natural foodstuffs without addition of salt. Although some species (for example, cattle, deer, etc.) consume salt eagerly when they are offered the substance or when they encounter it in salt licks, there is no proof that they need it for a healthy life.

Later, however, von Bunge formulated his famous hypothesis that extra dietary salt is needed by populations consuming predominantly vegetable products. The excess salt was presumed to be necessary for the more effective excretion of potassium. Bunge arrived at this conclusion on the basis of anthropological studies which he thought indicated that nomadic societies mainly subsisting on meats do not add salt to their food, whereas, once agriculture is developed, salting becomes necessary. He linked this with his observation that the intake of salt is accompanied by the rapid onset of potassium excretion. However, he emphasized that the large amounts of salt usually consumed are out of proportion to what he thought are biological needs. Osborne and Mendel later showed that salt requirements for growth of experimental animals are indeed low; their animals were able to live on traces of salt. Thus, one might have expected that this theory could never have achieved major importance; but, curiously enough, this has not been the case, and it is still cited without further discussion by current textbooks of nutrition and anthropology.

Objections to the theory should by now be all too obvious. So far as the increased potassium excretion after salt intake is concerned, such a reaction occurs unspecifically with many injuries and diseases. Bunge himself never offered any proof that the increased potassium excretion is biologically of advantage, although he implied it. Now we might be inclined to the opinion that these potassium losses are disadvantageous.

As for Bunge's anthropological data, he brushed away the objection that some African tribes mainly subsisting on a vegetarian diet use potassium-rich plant ashes rather than salt as a condiment. Even at the present time there exist a considerable number of societies which do

not add salt to their food. Important in this respect are studies by Kroeber of the food habits of Indians of the northwest Pacific. In the southern half of the area studied, salt was used, but not in the northern half. There was no predominance of plant or animal food in either region.

I have been given recent and direct anthropological evidence dealing with this question by various workers in this field.² I have learned of studies of places as distant as Melville Island in Australia, the Kalahari Desert in South Africa, and Tierra del Fuego which lead to the conclusion that the use or non-use of salt by various tribes is irrespective of the amount of agricultural products they consume. The observation is probably of deep significance that the Siriono Indians of eastern Bolivia, a hunting people, were ignorant of salt until it was introduced to them by an anthropologist. At first, they found it distasteful, but they later developed a craving for it. This indicates that, once some people are exposed to salt, they cling to its use stubbornly—as do so many of us to the consumption of alcohol, coffee, nicotine, etc.

When carefully weighing the available evidence, one cannot escape the conclusion that normal metabolic processes are possible without the adding of salt to natural foodstuffs. Why then do we eat salt? Merely to answer that certain societies like its taste whereas others do not would be trite and superficial. It seems to me that salt intake is probably correlated with emotional stimulation, a fact perhaps more keenly appreciated in the superstitions of the ancients than in our own rational approach. In view of the fact that this stimulation may be consciously or unconsciously pleasurable, it may be a causal factor in the craving for salt.

When we now try to deal with the possible consequences of adding salt to the diet, it must be emphasized that the nutritional essentiality of salt for humans has been firmly established. Only the quantity necessary is much in doubt. For a better understanding of this subject, it seems advisable to review briefly the main trends in studies dealing with the biological effects of sodium chloride.

One involves investigations of its distribution in the organs and the excretion of salt in health and disease. Others deal with the peculiar antagonism of sodium and potassium in living organisms. An important subject of investigation is concerned with why salt is an essential ingredient of any living cell; and another trend centers

² I wish to express my gratitude for the invaluable information given to me by Miss Jane C. Goodale, of the University Museum of the University of Pennsylvania, Drs. S. K. Lothrop, Hallam L. Movius, Jr., and John Marshall, of the Peabody Museum of Harvard University, and Dr. Harry Tschopik, Jr., of the American Museum of Natural History.

around the regulatory mechanisms, especially of the higher animals, developed for the maintenance of an optimum distribution in the body.

The high potassium content of the parenchymatous cells as opposed to the higher sodium chloride content of the blood serum has been recognized at least since von Liebig's time. Soon thereafter, many studies were conducted which gradually led to the recognition that, in disease, the low sodium chloride content of the cell increases while the potassium level decreases. Speculation as to how the body can maintain the high concentration gradients within the distance of a few microns between the surface of the cell and the blood plasma originally involved the idea of the specific permeability of cell membranes. It was held that the cell membrane is specifically permeable to potassium salts and almost impermeable to sodium chloride under normal conditions and that this is disturbed in disease.

Some investigators recognized the weaknesses of these hypotheses at an early date. Keller, in particular, attacked the idea that the separation of the minerals was due to the function of an "inert" membrane rather than to the discriminatory power of the whole living cell. He tried to replace this static view with his electrostatic theory, the study of which is still rewarding even after 50 years. Nevertheless, the permeability theory was accepted by most biologists until isotope studies proved that the cell membrane is equally permeable to both potassium and sodium salts and that the low sodium chloride content of the cell is due to its rapid expulsion from the cell. This mechanism is now often referred to as the "sodium pump," a term which might well be improved. Although these studies prove that the removal of sodium chloride from the cell is a dynamic process the disturbance of which leads to the accumulation of sodium chloride within the cell, and although many modern physiologists have demonstrated the weaknesses of the membrane theory, some investigators are not as yet ready to give it up entirely.

The modern concept of competitive antagonisms within enzyme systems, which gradually evolved from studies on minerals, has proved a useful tool for the understanding of some functions of sodium and potassium salts. In practically all biochemical and pharmacological studies, it has been shown that sodium and potassium have opposite functions. For example, potassium salts favor diuresis; sodium salts do the opposite. Many more examples have been cited. Lately, some evidence has been put forth that this antagonism is particularly important in regard to the action of chloride, the biological effect of which depends upon whether it is accompanied by sodium or potassium.

In studies concerned with the question of why sodium chloride is essential for the living cell, tenable ideas are sketchy. It seems im-

portant that a number of enzyme systems can only function if sodium chloride is present at certain concentrations. In view of the fact that we now believe that the life of the cell is maintained by enzymatic processes, sodium chloride is an integral part of the cell.

These dynamic equilibria are encountered in any living organism. In higher animals they are, to a considerable extent, under hormonal control, and disturbances of the more basic processes become noticeable if the hormonal control breaks down. Thus, one finds that in many diseases the sodium-potassium ratio in the tissues is disturbed, which probably interferes with metabolic processes bound to a constant sodium-potassium ratio. It is quite probable that in diseases which are of generalized character and are also accompanied by signs of renal damage, excess dietary salt can enhance the disturbances of the sodium-potassium ratio in the tissues and can thus contribute to the occurrence of metabolic failure; but these conditions are by no means clear, and the influence of dietary salt in health and disease can be better appreciated from its effect on the hormonal mechanisms than from its action on the basic processes.

The regulatory mechanisms of salt metabolism not only involve excretory glands but also every major organ directly or indirectly. One mechanism involving the central nervous system was discovered by Claude Bernard, who demonstrated that injury to a certain part of the medulla is followed by the excretion of large amounts of sodium chloride. Although a great deal of thought has been given to the central nervous regulation of mineral metabolism, neither its correlation to other regulating mechanisms nor how it is affected by changes in salt intake is clear.

Renal mechanisms in salt metabolism have received considerable attention. In fact, the salty taste of urine attracted the curiosity of people for a long time, and this was the reason for its medicinal use. Despite the enormous amount of work done since then on the excretory mechanism of the kidney, there is little evidence as to whether the dietary intake of salt eventually interferes with the excretory power. From an evolutionary point of view, it is well to remember that sodium chloride is a scarce material for most animals and is constantly reabsorbed by the kidney. Excess salt intake forces the kidney to excrete rather than to reabsorb it, which may "prove too much for it" in the long run. Such a view is supported by the rapid occurrence of histological changes in the kidneys of animals on a high dietary salt intake.

The regulatory mechanism for sodium chloride metabolism at present best understood rests in the adrenals. This function of the adrenal cortex was deduced in R. F. Loeb's studies on patients with Addison's disease. It was demonstrated that the low serum sodium

chloride values in patients with adrenal insufficiency are associated with continued urinary losses and are accompanied by low potassium excretion and increased serum potassium values. These changes are prevented by the normal secretion of the adrenal cortex involving steroids such as deoxycorticosterone, cortisone, and aldosterone. However, these hormones not merely influence sodium chloride and potassium salt metabolism but also play an important part in the regulation of protein metabolism (increased urea excretion in hyperadrenalism), carbohydrate metabolism (diabetes in adrenal hyperfunction; hypoglycæmia in adrenal insufficiency), blood pressure (hypertension in adrenal hyperfunction; low blood pressure in adrenal insufficiency), fat metabolism (changes in fat distribution in adrenal hyperfunction), pigment metabolism (discoloration in adrenal insufficiency). If, then, certain body functions are directly influenced by the adrenal cortical hormones, one might ask whether the intake of sodium chloride affects them because of its intimate relationship with adrenal function.

Abundant proof has been given that the deleterious effects of adrenal insufficiency can be at least partially counteracted by the administration of salt. This is true both for humans suffering from Addison's disease and adrenalectomized animals. On the other hand, salt intake is clinically undesirable in conditions in which the induction of hyperadrenalism is a disadvantage. As is known, the administration of either cortical hormones or salt may lead to similar symptoms in circulatory conditions, hypertension, and the like.

There exists by now a considerable body of evidence linking the functions of the cortical hormones to those of salt. Thus, hypertension produced by deoxycorticosterone is enhanced by simultaneous administration of sodium chloride. The kidney lesions and changes in food and water intake brought on by salt are potentiated by cortisone. There exists, furthermore, a considerable similarity in the influence which the adrenal cortex or salt exerts on carbohydrate metabolism. Hyperadrenalism is accompanied by increased deposition of glycogen in the liver and a high blood sugar. On account of the simultaneously increased urea excretion, it was deduced that the increased glycogen formation is due to catabolic processes in protein metabolism. The administration of salt leads to similar changes, namely, increased deposition of glycogen, reduced oxidation of glucose leading to increased blood sugar, and increased urea excretion. On the other hand, the reduced intestinal absorption of glucose on adrenalectomized animals can be equally corrected by a salt or by adrenal hormones. Unless one assumes that this latter finding is only due to improved intestinal blood supply, a more specific salt effect becomes probable, which leads to the conclusion that the effects of salt and of adrenal

hormones on carbohydrate metabolism are perhaps interrelated and that the mechanism of this effect is the stimulation of the cortex by salt. The restoration of carbohydrate metabolism in adrenalectomized animals may perhaps be due to the stimulation by salt of tissues which are functionally related to the adrenals. Additional material in support of such a theory will be given below.

Thus, the conclusion is unavoidable that cortical hormones and salt enhance each other's actions. But the question must be asked whether this relationship is important when salt is added to the diet, because one might argue that excess salt leads to a compensatory decrease in adrenal secretion of some of the hormones. This latter seems improbable because it has been shown experimentally that increased salt intake is followed by adrenal enlargement suggestive of adrenal hyperfunction. Clinically, high salt intake is probably related to hypertension, again a sign of high cortical hormone secretion.

Such a concept is supported by the effect of sodium chloride in a number of conditions which have in common: loss of sodium chloride by way of one of the body fluids, a drop in serum sodium chloride, and a favorable response to the administration of salt. In addition to Addison's disease, one should mention here heat exhaustion, various uremic conditions with or without histological signs of kidney disease, and high intestinal obstruction. It is usually believed that the benefit resulting from the intake of sodium chloride in these conditions is due to the replacement of sodium chloride which has been lost. A more careful analysis indicates a different mechanism.

In profuse sweating, the sodium content of the sweat and urine is rapidly reduced to such an extent that the total salt loss was, within 5 to 8 hours, less than that occurring in the same period without profuse sweating; a correlation between the salt content of sweat and adrenal activity has been fairly well established. The fact that various uremic conditions respond favorably to salt administration has been well known for at least 30 years. These studies are related to observations on "salt wasting nephritis." No balance studies indicate whether these patients actually had a negative salt balance. We were able to carry out such a study on one patient with a rapidly progressing uremia, profuse vomiting, and a drop in serum sodium chloride. This patient consumed only a little bread and milk and yet had a positive sodium and chloride balance. Similarly, it is known that the amounts of sodium chloride necessary for improving the condition of animals vomiting because of intestinal obstruction are much higher than the amounts actually lost.

The improvement produced by salt in the above conditions cannot be due merely to the replacement of salt losses but must be rooted partly in some pharmacological effect of the substance. The thera-

peutic effect becomes understandable if one assumes that the pharmacological effect of salt is that of adrenal stimulation, which results in the improvement of the existing "stress" condition. This theory would be more acceptable if it could be demonstrated that there is some reason for the assumption that a similar mechanism is partly responsible for the salt action in Addison's disease and in adrenalectomized animals. In human adrenal insufficiency, the amount of salt required to produce optimal clinical improvement is high, perhaps 50-100 times what might be considered "normal" minimum requirements. Whether these high requirements are only due to the high renal losses or whether they are also needed for their adrenal-stimulating effect has not as yet been studied. If the effect were only due to the replacement of losses, one should suspect that the amount just sufficient to bring about equilibrium of the salt balance should allow optimal clinical improvement. Whether the high doses are necessary to give equilibrium of the salt balance or whether this could be achieved with much smaller amounts has not as yet been studied. Some very sketchy information obtained on adrenalectomized rats indicated that the salt requirements for maximal improvement are much higher than those necessary to bring about equilibrium of the balance. This point, however, needs more attention in the future.

Finally, if one asks whether a similar mechanism may also be responsible for the action of salt in adrenalectomized animals, some pertinent data can be uncovered in the literature. As mentioned before, the intestinal absorption of carbohydrate is restored by salt or adrenal hormones. Similarly, fat resorption is improved. Salt or cortical hormones keep hemoglobin formation at normal levels, keep adrenalectomized rats fertile, and prevent cytological changes in the pituitary of adrenalectomized animals. Inasmuch as salt has scarcely a hormonal effect *per se*, its action may well be mediated by stimulation of tissues capable of partly replacing the adrenals.

The stimulating effect of salt probably sets in motion adaptive mechanisms involving enlargement of the liver, kidneys, and adrenals; this has been found in experimental animals. Similar conditions have been thoroughly discussed in many other "stress" conditions.

The possible changes, especially perhaps in the emotional sphere, brought on by the stimulating action of salt are, of course, entirely a matter of speculation. The greater responsiveness of people, if they were so stimulated, could have helped throughout the ages in the accumulation of knowledge. Whether this is one of the roots of the reverence which was accorded salt by the ancients can scarcely be guessed at this time.

It would be of inestimable value if we could be sure how long ago the majority of mankind learned to eat salt. It has been assumed that

this took place when peoples went through their neolithic stages, which were accompanied by the introduction of agriculture and which took place for the more complicated civilizations about 5 to 10 thousand years ago. The evidence for the simultaneous introduction of agriculture and salt eating is scant. The first known signs of salt mining were found in the Austrian Tyrol and date back to the late Bronze Age for that part of the world, about 1000 B. C. However, it is obvious that all the more complicated older cultures (Egyptian, Babylonian, Chinese) antedating that period knew the use of salt. One clue as to when tribes became used to salt is that Sanskrit and its daughter languages have no common root for salt and that therefore the Indo-Europeans, when first migrating, did not then know its use. For these reasons, we are still inclined to believe that salt was gradually more extensively used when the tribes went through their neolithic stage.

Is there any reason to assume that the constant use of salt as a stimulant has changed our intellectual capacity? If our previous speculations are correct, one must assume that man in the upper Paleolithic period (10 to 35 thousand years ago) did not salt his food; yet, Cro-Magnon man created magnificent art. Intellectually, therefore, he was our equal. He differed from us only in his lack of knowledge. Thus, although salt eating did not change man intellectually but may have facilitated learning, it possibly was an important historical force.

Are there, finally, any reasons why the physician and public-health worker should recommend a certain level of salt intake on the basis of present-day scientific knowledge? There is no question that there is a sound basis for the prescribing of low-salt diets in many diseases, particularly those involving the circulatory system. When it comes to normal people, however, recommendations are infinitely more difficult. It is certainly true that the chemistry of the body does not require the addition of salt to our food. The physician, however, is not primarily interested in the mere metabolic processes but in the general welfare of his patients, and he should consider that the quickened pace of a more complicated society demands persons with a heightened responsiveness. Salt may be one of the ingredients producing this effect.

Roman Garland Sarcophagi from the Quarries of Proconnesus (Marmara)

By J. B. WARD PERKINS

Director, British School at Rome, Italy

[With six plates]

FEW OBJECTS of antiquity have received more attention from the archeologist and the art historian than the rich series of sculptured Roman sarcophagi, dating from the second to fourth centuries, examples of which, of varying degrees of refinement, can be seen in most of the museums of the western world. The literature is vast and scattered, dealing both with individual pieces and with groups classified by style, subject matter, or location. For all its bulk, however, this literature is curiously stereotyped. There are innumerable studies of these sarcophagi as documents for the history of Roman art; others, less numerous but equally fruitful, treating them as social documents, indicative of the status and beliefs of the persons buried in them. Little attention has, on the other hand, been paid to other more prosaic, but no less important, questions which they raise. Where were they made, and by whom? How were they produced and distributed? What was the relation between sculptor and client?

These are in themselves vital questions to anyone who wishes to study Roman sarcophagi in their proper setting, rather than as museum pieces, detached in time and space, and unrelated to the lives and aspirations of those who made them and used them. They are, moreover, questions that need to be answered before one can hope to get a true picture of them either as works of art or as social documents. In studying, for example, the representation of a particular pagan myth, it is obviously essential both for the art historian and for the student of ancient beliefs to know whether any individual piece was created for a particular client, or whether it was a school piece, one of a group of standardized products, manufactured in quantity for sale in the open market. The point is an obvious one; but it is all too often ignored.

In all this the student of Roman sarcophagi, as of so many other fields of classical antiquity, has been the victim of an attitude of

mind—that of generations of classical archeologists preoccupied above all with problems of style and stylistic attribution. It is true that in recent decades there has been a steady tendency to substitute for this predominantly esthetic approach one borrowed from archeology proper and based primarily on typology and systematic classification. The result has been a series of iconographic and regional studies, which have greatly advanced our knowledge of individual categories of sarcophagus, and have produced a valuable framework of reference for further research. But even studies such as these are, by definition and intent, limited in their approach; in very few cases have they taken into account the practical problems of output and distribution that conditioned the activities of sculptor and client alike. It is these that are the subject of the present article, as illustrated in an important group of second- and third-century sarcophagi, one of the finest of which is now at the Smithsonian Institution.

The sarcophagus at the Smithsonian Institution is one of a pair that were acquired in Beirut, Lebanon, by Commodore Jessie D. Elliott, USN, and brought to the United States in 1839 aboard the U. S. S. *Constitution*. The circumstances of their discovery are not recorded; but from a study of the sarcophagi themselves it is evident that they were found together, presumably in some underground burial chamber in Beirut itself or in the immediate neighborhood; and that, although looted in antiquity, they had remained concealed and protected until very shortly before the time of their acquisition. On their arrival in the United States, Commodore Elliott presented one of them to the National Institute for use as a final resting place for the remains of President Andrew Jackson; its companion he presented to Girard College, near Philadelphia, as a tomb for its recently deceased founder, the distinguished philanthropist Stephen Girard (1750–1831). Neither was in fact put to its intended use. Jackson declined to be buried in a tomb which, he felt, would not be in keeping with his republican principles, and Commodore Elliott accordingly gave the National Institute permission to retain it as a historical relic. It was first exhibited at the Patent Office, and was turned over to the Smithsonian Institution in 1860, where it now stands in front of the Arts and Industries Building. Its companion, after standing for many years in Girard College, was recently transferred on permanent loan to Byrn Mawr College, where it can now be seen in front of the deanery, close to the entrance to the library (1).¹

The body and lid of the Smithsonian sarcophagus (pls. 1 and 2) are carved from single blocks of Greek marble, white, tinged with blue in more or less definite streaks, and of a uniform crystalline

¹ Numbers in parentheses refer to notes at end of text.

structure, with medium-sized crystals. The body, which measures 7 feet long by 3 feet 6 inches wide by 3 feet 1 inch high, is carved on all four faces, with moldings at top and bottom and, between them, a formal design of looped garlands, variously supported and enriched with small decorative motifs in the spaces above each loop. The massive gabled lid, with acroteria at the four corners and slightly irregular in shape, measuring 7 feet 4½ inches (7 feet 5½ inches) long by 3 feet 10 inches (3 feet 10½ inches) wide by 2 feet 1 inch (2 feet 1½ inches) high, is carved only on the front and ends; it was fastened to the body with six iron cramps, sealed into place with lead. The contents of the sarcophagus were looted in antiquity through a hole cut in the upper part of the left-hand end, but apart from various clean breaks at the back and ends it is otherwise intact and in good condition. Its companion at Bryn Mawr (pl. 3) is of identical marble and carved to a very similar design. Its proportions are such that it appears rather less bulky than the Smithsonian sarcophagus, although the dimensions of the body are in fact slightly larger than those of its fellow (7 feet long by 3 feet 6 inches wide by 3 feet high) and those of the lid almost the same (7 feet 5 inches by 3 feet 10 inches by 2 feet 2 inches). It, too, was looted in antiquity through a hole cut in the rear right corner of the lid, which the thieves evidently found too heavy to move, even although it had not been fastened with metal cramps; as it now stands, the lid has been placed back to front. Both sarcophagi have a panel reserved for an inscription, but only the Bryn Mawr sarcophagus was actually inscribed. The text, *IVLIA. C. FIL. MAMAEA. VIX. ANN. XXX* (2), records that the sarcophagus contained the body of Julia Mamaea, daughter of Gaius, who lived to the age of 30. The name, Julia Mam(m)aea, is the same as that of the Syrian wife of Emperor Alexander Severus (A. D. 217-235), who was murdered in Syria, and it is perhaps not altogether surprising that, when first found, the pair of sarcophagi were thought to be those of the imperial couple—a fact which no doubt helps to explain the scruples of Andrew Jackson. In actual fact, although the date cannot be very far wrong, the purchasers of these sarcophagi must have been folk of much humbler standing; Julia Mamaea was probably the daughter of the couple who were buried in the Smithsonian sarcophagus, whose names and style were no doubt prominently recorded elsewhere in the mausoleum in which the pair of sarcophagi once stood.

The two sarcophagi from Beirut belong to a distinctive group of sarcophagi which were quarried on the island of Marmara (the ancient Proconnesus) near the southern entrance to the sea of the same name, and which were exported over the greater part of the eastern Mediterranean. In antiquity, as later, the island was one of

the principal sources of fine white marble. The earliest reference to this marble is a statement by Vitruvius (3) that king Mausolos of Halicarnassus, the builder of the fabulous Mausoleum, used it to veneer the walls of his palace, and it seems to have early acquired and to have long retained a reputation for quality among the cities of western and southwestern Asia Minor, where there are a number of inscriptions stipulating that a particular monument (in several cases the monument in question is a sarcophagus) is to be made of this specific marble (4). Despite its uniform grain and fine translucent surface, it was never much in demand for statuary, no doubt on account of the difficulty of getting a large enough block that was free from blue discoloration. But as a building material it was rivaled only by the Pentelic marble of Attica. This, the marble of the Parthenon, was in some respects a finer marble, but it had two serious disadvantages: there were few beds from which it was possible to quarry really large blocks that were free from veins of impurities, which were both unsightly and a source of structural weakness; and the location of the quarries on Mount Pentelikon meant heavy initial expenditure from quarry to shipboard. Proconnesian marble suffered from neither disadvantage, and it must always have been considerably cheaper than its rival.

These were not, of course, by any means the only Greek marbles of this type to be quarried, some of them virtually indistinguishable from Proconnesian both in quality and appearance. Few if any others, however, were exploited for more than local use, certainly none on a scale approaching that of the quarries of Proconnesus after the great expansion of production that took place during the first century A. D. The immediate result of the reestablishment of the Pax Romana by Augustus, and of the great imperial building programs carried out both in the capital and increasingly, as time went on, in the provinces, had been to create an enormously increased demand for fine building materials. Augustus' well-known boast that he found Rome a city of brick and left it a city of marble had a solid foundation of truth; and although most of the marble of his own buildings came from the newly opened quarries of Luni (the modern Carrara), which remained for several centuries the principal source of supply for domestic Italian use, his successors made ever-increasing demands upon the supplies of finer-quality marble that were available in the provinces, principally in Greece and Asia Minor, although there were also important quarries in North Africa ("giallo antico") and Egypt (porphyries and granite). Already by the middle of the first century A. D. we begin to detect the impact of the new market on the traditional sources of supply.

As far as we can tell, the actual quarrying methods remained very much what they had been before—what, indeed, they were to remain until the introduction in very recent times of machines for the extraction of the marble from the quarry face: marble working is in many respects a very conservative trade, and a visit to the quarries of Carrara can still teach one much about ancient techniques of extraction and transportation. What was new was a revolution in the scale and organization of production, and in the relations between producer and client, a revolution that was greatly facilitated by the fact that from the reign of Tiberius onward mines and quarries were, by law, imperial property. In Greek times normal practice seems to have been to quarry a particular consignment of marble for a particular purpose, at any rate in the case of an order of any size. The Roman answer to the enormously increased demand was not only to open up large numbers of fresh quarry faces, but also to introduce what may not improperly be termed methods of mass production. Apart from such exceptional cases as the blocks for Trajan's Column or the outsize columns used in some of the great Imperial monuments (e. g., the Pantheon), the marble was henceforward quarried in bulk to a variety of convenient shapes and sizes and held in stock against future orders (5).

The principal evidence for the reorganization is to be found in the simple fact that at various times within the first century A. D. the marble from a limited number of imperially owned quarries did begin to reach the foreign market in quite unprecedented quantities. There is, however, also the evidence of the quarry marks, carved or painted on individual blocks of marble, a large number of which have been found both in the quarries themselves and in the marble yards of the importing cities. These quarry marks consist normally of one or more serial numbers, very often accompanied by the name of a responsible official and a date, and they attest an elaborate system of accounting, with individually numbered quarries and working faces and periodical stocktaking. The fact that individual blocks occasionally bear two different dates shows that they were liable to be held in stock for considerable periods.

The first and immediate result of this reorganization was to increase greatly the amount of fine marble available for building purposes. In Rome we can first detect the results with certainty during the reign of Nero (A. D. 54–68), and by the end of the century the trickle had become a flood. In the provinces the full results were not felt until rather later, not really before the second century. In Tripolitania, for example, an outlying and relatively unimportant area, the first large-scale importation of foreign marble took place during the reign

of Hadrian (A. D. 117-137), and it was not available in bulk until the middle of the second century. The impact, when it came, was for that reason all the more striking. By the end of the second century there was hardly a major public building in Lepcis Magna or Sabratha that had not been at least partially rebuilt in the new material.

The effects were not, however, limited to the mere substitution of one material for another. The structural properties of marble differed widely from those of the building stones available in many of the provinces to which it was now imported. This alone was bound to have an effect upon local architectural practices. There were, however, other and more far-reaching consequences. Once again, the case of Tripolitania will serve to illustrate what in varying degrees was happening in many other parts of the Roman world. Here the monumental architecture of the earlier Roman period, i. e., down to the end of the first century A. D., was still a typically provincial architecture, in that the classical models on which it was based were often profoundly modified by local traditions, building practices, and materials. This local style finds no expression whatsoever in the marble architecture that succeeded it. The constructional forms and ornament of the marble buildings of second-century Tripolitania have nothing to do with the previous architectural history of the province; they were those of the regions from which the marble itself was imported (with some admixture of motifs derived from the contemporary architecture of the capital), and it is quite evident that in this particular case the shipments of partially prefabricated building materials were accompanied by the establishment of workshops capable of carving and handling a material of which the local masons had had no previous experience. This was a somewhat extreme, but by no means unique, case. All over the Empire, even in Rome itself, we find evidence of the establishment of permanent or temporary workshops, whose business it was to handle the consignments of marble from the great exporting quarries. What had happened was that, under conditions of widespread peace and commercial prosperity, it was the highly organized producer who captured the market; and, as is the rule in such cases, what had started as a practical reorganization, designed to increase output, became in the event a powerful factor in shaping the development of architectural style and practice throughout the eastern, and over large parts of the central and western, Mediterranean.

It is hardly surprising that the methods employed with such success in architecture should have been applied also to the manufacture of sarcophagi. Here we lack the evidence of inscriptions; but fortunately that of the sarcophagi themselves is quite explicit. The Italian quarries, which supplied the bulk of the marble used in the

workshops of the West, seem to have been content to produce rectangular, coffin-shaped blocks, without attempting to give them any more finished form. But the two other major centers of production for export, Attica and Proconnesus, both in varying degrees adopted the methods of prefabrication that had proved so successful in the architectural market. In the case of the fine figured sarcophagi of Attica, examples of which were shipped all over the Mediterranean, it is clear that in a great many, very possibly in all, cases the figured designs were sketched on the sarcophagus in low relief before despatch. All that remained was for the carving to be completed on receipt, either by skilled workmen who accompanied an individual consignment, or by workshops established in the major receiving centers in the provinces (6)—an ingenious compromise, whereby the workshops of Attica were able to make the fullest and most economical use of the local resources of skilled craftsmanship upon which the quality of their products ultimately depended, while at the same time avoiding the damage to fine detail that would certainly have taken place had these massive but fragile objects been shipped fully carved.

The workshops of Proconnesus were less ambitious. They adopted a system whereby the broad lines of the finished design were established before despatch, but considerable latitude was left to the receiving workshop as to the working-out of the design. In the case of one widely distributed series, all that the quarry did was to shape the body and lid, the former as a plain rectangular trough, the latter to the roughed-out outline of a gable roof with acroteria, just as we see it on the back and one end of the lid of the Smithsonian sarcophagus. Sarcophagi so shaped were widely used locally, in Thrace and northwestern Asia Minor; and they were exported in large numbers to the Danube provinces and northern Italy, and as far afield as southern France (7). The advantage of this particular design was that it greatly reduced the weight, and therefore the cost, of transport, while leaving wide latitude to the importing workshop to develop the superficial ornament in accordance with local taste.

The series to which the Smithsonian and the Bryn Mawr sarcophagi belong was more specialized. Here, in addition to shaping the lid, the quarry workshops also roughed out the body to the simple design illustrated on plate 4, figure 1, a sarcophagus now in the grounds of the American University at Beirut. There were minor variations from one sarcophagus to the next. The design might be carved on all four faces, or alternatively on three only, leaving the back plain; the central motif on the front might be a panel destined to carry an inscription or it might be just another circular boss, like those within the two flanking loops; or again, the upper molding might be omitted altogether, indicating presumably that the dimensions of the parent

block were found to be insufficient. These were, however, minor variants within what was in practice a remarkably stereotyped design. And the fact that this design is found identically on the unworked faces of sarcophagi as widely scattered as in Asia Minor, in Syria, and in Egypt, leaves no room for doubt that it was carved before shipment.

It was only on arrival at its destination that the sarcophagus was worked up into its final form. That, too, is proved beyond question, not only by the consistent differences that distinguished, for example, a sarcophagus found in Syria from one found in Egypt or Asia Minor, but also by the fact that the sculptor of the finished piece has very often been able to take into account the location of the sarcophagus within the tomb for which it was destined, and so to concentrate his attention upon those sides that would be most conspicuously visible after installation. One or more sides might be left rough, just as received from the quarry, and in certain extreme cases this is the only surviving indication that a particular sarcophagus belonged to the series in question. Such, for example, are a pair of fine sarcophagi from Tripoli, in Syria, now in the museum at Istanbul (8), the one showing on the front a woman reclining on a couch and attended by a slave girl, the other a figured scene from the story of Hippolytus and Phaedra, which is clearly inspired by the representations of the same scene on contemporary Attic sarcophagi. The marble of both, however, is Proconnesian and the telltale garland design can still be seen roughed out, in the one case on the two ends, in the other on the back. They were found moreover, with a garland sarcophagus of unusual elaboration but otherwise conventional design (pl. 4, fig. 2) (9), and there can be no doubt that all three were shipped from Proconnesus as potential garland sarcophagi, roughed out in the usual manner.

The three sarcophagi from Tripoli are exceptional, a shipment that found its way to a local workshop of unusually cosmopolitan tastes and competence. Normally the importing workshops seem to have been content to work within the limits imposed by the parent design. The garlands are supported by Victories or Cupids standing on bases or brackets, or by rams' or bulls' heads; the circular bosses above the garlands are worked up into human heads, or rosettes, or small birds; the garlands themselves are variously carved, with or without pendent bunches of grapes. By cutting a little deeper into the marble the sculptor could introduce secondary motifs in low relief, such as the ribbons which figure on many of the sarcophagi, trailing into the field above and below the garlands. Alternatively, he might simplify the design by leaving parts of it substantially uncarved, one of the commonest of such simplifications being to treat the garlands as the plain, bolsterlike loops that figure on the Bryn Mawr sarcophagus. He might even be content merely to work over the original quarry design,

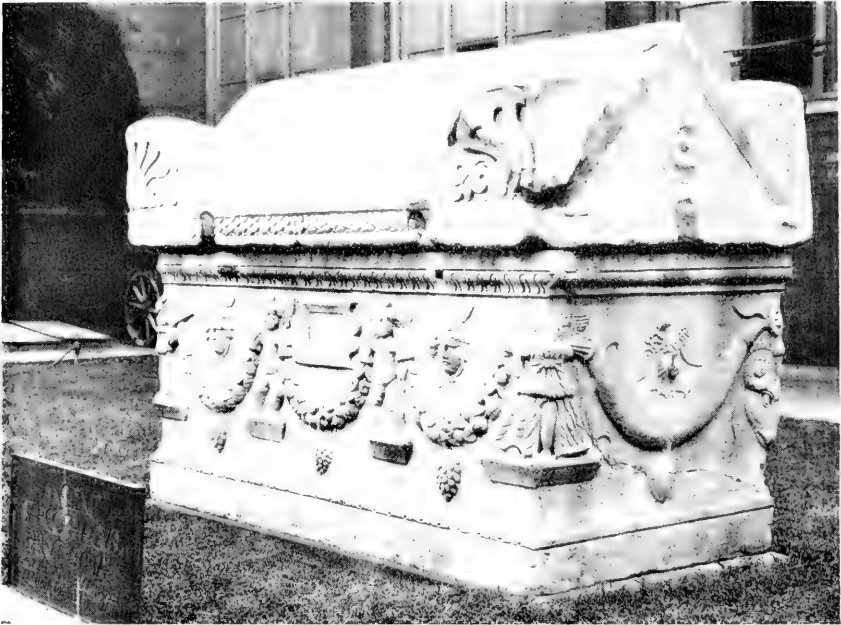

1. Smithsonian Institution sarcophagus, front and right-hand end.

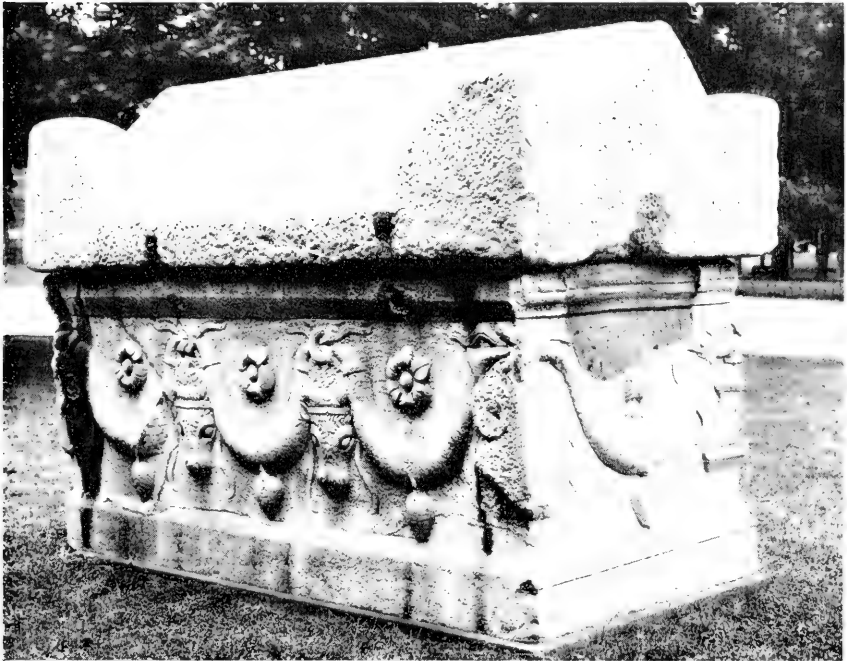

2. Back and left-hand end of the Smithsonian sarcophagus.

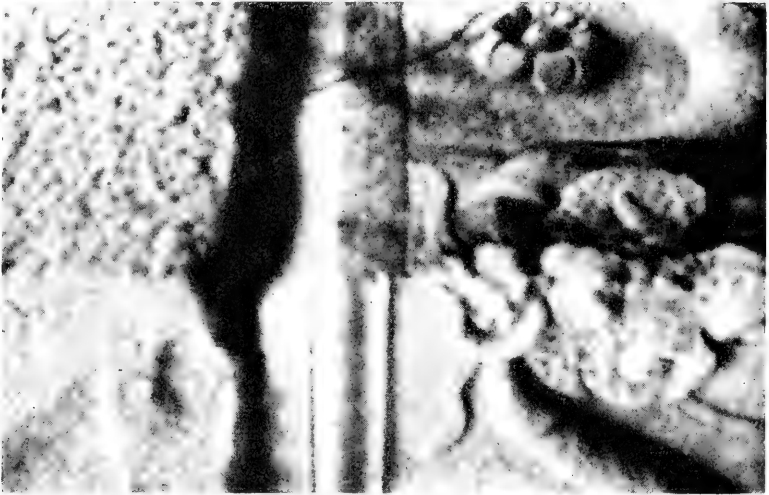
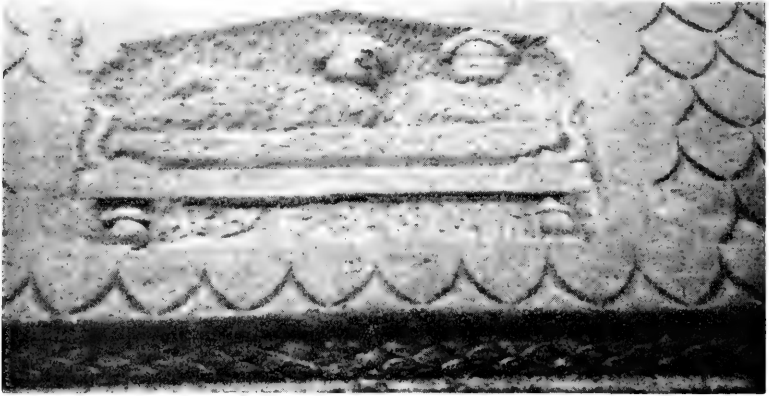

Details of the Smithsonian sarcophagus. *Left*, front; *center*, rear angle; *right*, lid.



1. Bryn Mawr sarcophagus, front. (Photograph from Girard College.)



2. Bryn Mawr sarcophagus, back. (Photograph from Cornelius Vermeule.)



1. American University, Beirut, sarcophagus.



2. Tripoli (Syria) garland sarcophagus. (Photograph from British School at Rome.)



1. Detail of front of Tripoli sarcophagus.
(Photographs from British School at Rome.)



2. Detail of end of Tripoli sarcophagus.
(Photographs from British School at Rome.)

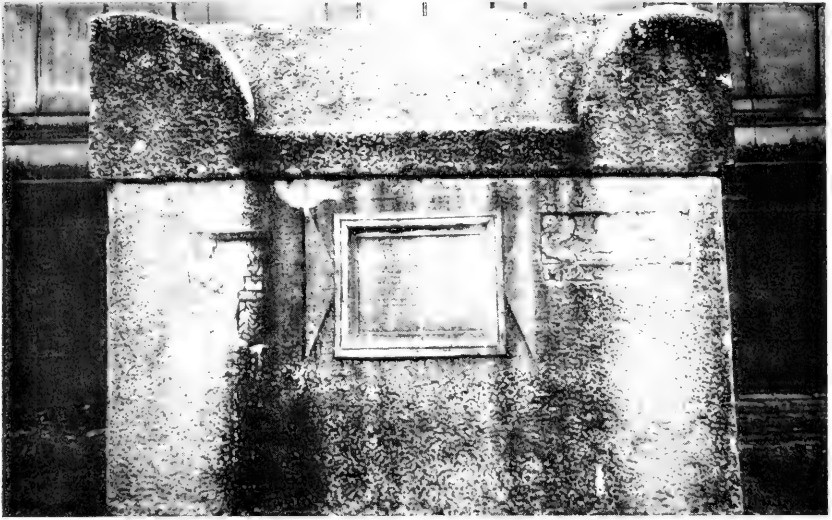

1. Byzantium (Istanbul) sarcophagus. (Photograph from British School at Rome.)



2. Detail of left-hand panel of Byzantium sarcophagus.



3. Detail of right-hand panel of Byzantium sarcophagus.

dressing and smoothing the surfaces, but making no attempt to add any fine detail. In an extreme case the sarcophagus might even be used just as it was received from the quarry without any further refinement, as in the case of the sarcophagus illustrated in plate 4, figure 1. The range of possibilities was very wide, and we can rarely do more than guess at the reasons that lie behind the idiosyncrasies of a particular piece—economy, the shortage of competent local craftsmen, a sudden emergency, the taste of an individual sculptor or client. But such individual traits are no more than variations on a basic theme, a theme that was determined in broad outline by the form in which the sarcophagus was shipped from the quarry.

How did this form first come to be adopted? This is one of the as yet unresolved problems connected with this series of sarcophagi, and we must be content to state such facts as do seem to be reasonably established. The close similarities that exist between the more elaborate of the finished pieces, wherever they are found, make it clear that the designs carved on them all derive from a single source, either an actual individual sarcophagus or else a small group of very closely related pieces. The Smithsonian sarcophagus, with its wide repertory of figures (Victories, Cupids, bulls' heads, rams' heads) and secondary motifs (Medusa heads, rosettes, bunches of grapes) contains nearly all the motifs that can be attributed to the archetype, and, allowing for certain differences of detailed treatment, it may well give a very good idea of its general appearance. How or why this particular iconographic scheme came to be adopted in the first place is another matter. The individual motifs are all such as would have been available to a sculptor working in northwestern Asia Minor in the early years of the second century, and we may guess that garland sarcophagi of this sort were first produced for local use. If so, they were not long in reaching a wider market. The earliest well-dated example is that of Caius Julius Celsus Polemaeanus, whose tomb chamber beneath the library at Ephesus was completed somewhere about A. D. 135; and it cannot have been very long after this that the first sarcophagi of this sort were reaching Syria and Egypt and the cities of Pamphylia and Cilicia, in southern Asia Minor. These first examples must have been accompanied by craftsmen who set up workshops in certain favored centers, such as Alexandria, and who there established the pattern of the finished design in local usage. The practice of carving a simplified version of the garland design before shipment was probably adopted with an eye to those markets that were dependent on relatively unskilled local workshops (the saving in weight can hardly have been a sufficient reason in itself); and the form of it may well have been suggested in the first place by

the way a sculptor would naturally lay out a pattern of this sort on the surface of the stone before starting work.

Whatever the circumstances in which the type of the garland sarcophagus was first established in the marble yards of Proconnesus, there can be no doubt of its subsequent popularity, especially in the provinces of the eastern Mediterranean seaboard. Well over a hundred examples are known from this area, and this can only be a tiny percentage of those that once lined its crowded cemeteries. Of the 30 recorded marble sarcophagi from Alexandria, 29 were of this type (10); and Professor Mansel's recent excavations in the cemeteries of Perge, in Pamphylia (11), are a vivid reminder of how much has been lost on other, less favored sites. Outside Egypt they are found principally in Syria and the coastlands of Asia Minor, in both of which areas they constituted by far the largest single group of imports. They are not found at all in mainland Greece, and only a single example in Cyrenaica, where the Attic workshops seem to have secured a monopoly comparable to that of the Proconnesian workshops in Alexandria. In the West, the distribution was rather different. The plain gabled sarcophagi of Proconnesus found a good market in northern Italy, and a few garland sarcophagi reached Rome itself. On the whole, however, the exporters of Proconnesus seem to have found it wiser to conform to Italian practice, and the very large quantities of Proconnesian marble that were used in the sarcophagi of Italy and southern Gaul, and to a lesser extent in the other western provinces, seem to have been imported almost exclusively in plain form, without any prior shaping in the quarry workshops.

To the art historian these sarcophagi have a value quite apart from the glimpse that they afford of the sculptor at work and of the factors that controlled his output. The essential unity of the series offers an invaluable connecting thread for the study of a whole range of otherwise disparate objects, scattered over territories whose detailed artistic development within the Roman period is still all too little known. The garland sarcophagi were not only imported; they were copied, and copied widely, by local craftsmen working in local materials. In the Syrian coastlands the commonest form of decorated sarcophagus in the Roman period is derived so closely from these imported marble models that their earliest commentator, mistaking the nature and direction of the relationship, was led to claim the garland sarcophagus as a specifically Syrian creation (12). Nor was it only the more elaborately carved pieces that were copied. Local craftsmen found the simplified quarry version of the design both congenial and easy to copy, and it, too, passed into the local repertory—a remarkable and possibly unique instance of a purely abstract design passing into provincial Roman art from a purely classical source. Much the same thing hap-

pened in Egypt. In the Kom el-Shukafa catacomb, for example, we find the frontals of the grave recesses carved with garlands and rosettes, in obvious imitation of the familiar marble design (13); and at the same time we also find the local workshops producing a version of the quarry design in a dark local stone, several examples of which can still be seen in Alexandria itself (14) and, by some unexplained twist of circumstances, two others in Ravenna, beside the church of San Vitale. In at least two cases it was not only the design that was copied but also something of the methods of producing it. At Ephesus, which had a good white marble of its own, there is a local series of garland sarcophagi which is barely distinguishable from those of Proconnesus, and which may very well have been inspired in the first place by that of Tiberius Julius Celsus Polemaeanus, already referred to as having been buried in a *heroon* beneath the library that bore his name. There is also a series of miniature sarcophagi based on the same model, and these were widely exported within Asia Minor and even, in exceptional cases, abroad, to Athens and to Rome (15). So, too, in the region of Salonica a number of sarcophagi that are virtually indistinguishable from those of Proconnesus were carved in the coarse, grayish-white marble from the nearby quarries of Thasos. Even in Italy, there can be very little doubt that the few examples that were imported from Proconnesus had an important influence on (and may even have originally inspired) the large and varied Italian series of garland sarcophagi. In this case, however, it is difficult to be more precise until the latter have been more thoroughly studied.

To the student of Roman funerary symbolism, the Proconnesian garland sarcophagi have little to offer. There is an important distinction (all too often disregarded by those who discuss the history of religious ideas) between those symbols that are consciously selected and used to convey a particular idea and those others whose use is determined mainly or even entirely by association and custom. The motifs used on the Proconnesian sarcophagi fall decisively into the later category. To the average purchaser of one of these sarcophagi the message conveyed by its ornament can have been little more profound than the cherubs and scrollwork on an eighteenth-century tombstone. The fact that so many people were prepared and able to purchase them is, on the other hand, an interesting commentary on the distribution of wealth in the cities of the eastern provinces. However economically organized, the quarrying and transport of one of these bulky objects must have been a very heavy item in the budget of any private individual. It was probably this fact above all that gave the Proconnesian quarries their advantage in the eastern Roman market. Produced in very large quantities and loaded almost directly on

shipboard, without any costly land transport, they must have been one of the cheapest items of their quality available.

Rather than the artistic qualities or the social significance of these sarcophagi, however, it is the evidence which, in common with many other aspects of the marble trade, they yield of Roman economic organization that makes them of particular interest to ourselves. They show that the methods of standardized production and prefabrication which we are apt to regard as a discovery peculiar to the present mechanical age have ample precedent in antiquity. As so often when one comes to examine the detail of almost any aspect of Roman achievement, one is brought vividly up against the fact of its essential modernity.

NOTES

1. For information about, and facilities for studying, these two sarcophagi the writer is indebted to the authorities of the institutions concerned; also, for much valuable help, to Karl S. Brown, Prof. Howard Comfort, Perry B. Cott, Harold W. Parsons, M. Henri Seyrig, Prof. Lily Ross Taylor, and Cornelius Vermeule.

2. *Corpus Inscriptionum Latinarum*, iii, 1, 15* = iii, Suppl. 1, 6694.

3. ii, 8, 10; cf. Pliny, *Hist. Nat.*, xxxvi, 47.

4. For sarcophagi, see *Corpus Inscriptionum Graecarum*, 3268, 3282, and *Inscriptiones Graecae ad Res Romanas Pertinentes*, 1464, 1465 (all from Smyrna); Arif Müfid Mansel, *Excavations and researches at Perge (Türk Tarih Kurumu Yayınlarından, ser. 5, No. 8)*, p. 4, No. 4 (at Perge, in Pamphylia), 1949, Ankara.

5. For this reorganization see the article "Tripolitania and the Marble Trade" cited in *Bibliographical Note*, p. 467.

6. See the article "The Hippolytus Sarcophagus from Trinquetaille" cited in *Bibliographical Note* p. 467.

7. They are common, for example, in the cemeteries of Aquileia and Concordia. The example illustrated in plate 6, figure 1, is characteristic of those found in the cemeteries of Byzantium (Constantinople), which were commonly left rough, as received from the quarry, with one or more small carved or inscribed panels cut in the principal face. The two details of the same sarcophagus (pl. 6, figs. 2 and 3) illustrate very clearly the successive stages of dressing the marble: with a coarse punch, to shape the whole block; with a slightly finer punch, to rough out the right-hand panel (which for some reason was never fully carved) and to prepare a more level surface for the carving of the left-hand panel; with a claw chisel, for the triangular panels on either side of the inscription (the secondary surfaces of a sarcophagus were often left at this stage); and a smooth chisel for the carved detail. For a recent discussion of this group, see A. M. Mansel, *Belleten*, vol. 21, p. 395 ff.

8. G. Mendel, *Musées Impériaux Ottomans: catalogue des sculptures grecques romaines et byzantines*, vol. 1, No. 26, pp. 109-114, 1912, and vol. 3, No. 1170, pp. 412-414, 1914.

9. *Ibid.*, vol. 3, No. 1159, pp. 397-399.

10. The greater part of the Alexandrian series has been well, though not very accessibly, published by E. Breccia in *Le Musée Gréco-romain (Municipalité d'Alexandrie) 1922-1923*, pp. 10-19, 1924, Alexandria; see also subsequent volumes in the same series, variously titled, for the periods 1925-31 (Breccia), 1932-33 and 1935-39 (A. Adriani); and A. Rowe, *Illustrated London News*, June 25, 1949, p. 893.

11. See note 3, above.

12. E. Michon, Syria, pp. 295-304, 1921. Commodore Elliott's two sarcophagi are presumably to be identified with Nos. 12 and 13 on Michon's list (from Beirut, present whereabouts unknown).

13. Alan Rowe, Kôm el-Shukafa (reprint from Bulletin de la Société royale d'archéologie d'Alexandrie, No. 35), 1942.

14. e. g., Breccia, op. cit., pl. XII, figs. 2, 3.

15. A. L. Pietrogrande, Nuova serie asiatica di urne e di piccoli sarcofagi, *Bullettino del Museo dell'Impero Romano*, vi, pp. 17-37, 1935 (appendix to *Bullettino della Commissione Archeologica del Comune di Roma*, lxiii, 1935).

BIBLIOGRAPHICAL NOTE

The pioneer of a broader approach to sarcophagus studies was the late Gerhart Rodenwalt, whose article "Sarkophagprobleme" in *Roemische Mitteilungen*, vol. 53, pp. 1-26, 1943, sums up his own previous work and is by far the best general statement of the whole problem (Abb. 7 and 8 of this article illustrate a Proconnesian garland sarcophagus from Viminacium on the Danube). An outstanding detailed study, in which a small group of sarcophagi found together in Rome are considered as documents both for the artistic development and for the beliefs of the period, is that of K. Lehman-Hartleben and E. C. Olsen, *Dionysiac sarcophagi in Baltimore*, 1942, Baltimore; for sarcophagi as documents for the beliefs of their purchasers, see further the works of Franz Cumont, *passim*, and Jocelyn Toynbee and John Ward Perkins, *The shrine of St. Peter*, chap. 4 (b), "Beliefs," 1955. As examples of valuable regional and iconographic surveys, one may cite C. R. Morey, *The sarcophagus of Claudia Antonia Sabina and the Asiatic sarcophagi*, *Sardis*, vol. 5, p. 1, 1924, Princeton; M. Lawrence, *Columnar sarcophagi in the Latin West*, *Art Bulletin*, vol. 10, pp. 1-45, 1927; *id.*, *The sarcophagi of Ravenna*, *College Art Association of America*, 1945; Fernand Benoit, *Sarcophages paléochrétiens d'Arles et de Marseille* (supplement à *Gallia*, V), 1954, the last-named author being one of the few students to have appreciated the vital importance of identifying the source of the material from which a sarcophagus is made.

Other articles by the present writer on the marble trade in Roman antiquity, the results of which are cited largely in the preceding pages, are *Tripolitania and the marble trade*, *Journal of Roman Studies*, vol. 41, pp. 89-104, 1951 (the organization of bulk trade in marble for architectural purposes); and *The Hippolytus sarcophagus from Trinquetaille*, *ibid.*, vol. 46, pp. 10-16, 1956 (the carving and shipment of Attic sarcophagi).

Stone Age Skull Surgery: A General Review, with Emphasis on the New World

By T. D. STEWART

*Curator, Division of Physical Anthropology
United States National Museum*

[With 10 plates]

NEARLY A CENTURY has elapsed since anthropologists first realized that Stone Age men practiced operations on the living human head—operations which sometimes were spectacular and often were successful. This came about as a result of a trip to Peru in 1863–65 by E. G. Squier, the American diplomat-anthropologist. While in Cuzco Squier obtained part of a human skull that had a rectangular opening in the forehead made by canoe-shaped cuts crossing one another in a tick-tack-toe pattern (fig. 1). Not having seen such a thing before and wondering whether the opening could have been made in life, Squier sought the opinion of Paul Broca, the leading French physical anthropologist of the day. The latter saw signs of infection in the porosity of the surrounding bone and therefore declared (1867) that this Peruvian Indian had lived about 15 days after his operation. Although the present writer raised doubts recently (1956) about the accuracy of Broca's interpretation in this instance, this belated criticism did not negate the fact that discoveries of many specimens during the 1870's and 1880's in both the Old and New Worlds had confirmed the antiquity of skull surgery. These discoveries also had told much about how and why the operations were practiced so commonly and so widely.

Two cases little publicized heretofore bear witness to the spectacular nature of skull surgery (trephining or trepanning) as practiced in the New World (pls. 1 and 2). One of these, like Squier's case, comes from Cuzco but differs in showing 7 healed circular openings (the largest number previously reported is 5—MacCurdy, 1923). Very likely this individual had undergone seven separate successful operations. The other case is a mummy from Utcubamba, probably in the

Central Highlands (Vidal Senèze, 1877), and shows a large unhealed circular opening in the left parieto-occipital region made by the drilling technique, a somewhat uncommon procedure. Although larger openings made by other techniques have been reported, this one seems to be the largest made in this way. It should be noted also that the appearance of the opening in the scalp indicates that the operation was made in life. However, since the bone gives evidence of being unhealed, the operation, as the saying goes, was successful, but the patient died.

The writer's contribution to this subject, mentioned above, is based on a series of 75 Peruvian skulls in the United States National Museum—many previously undescribed—and introduces the idea that evidence has been preserved regarding the nature of the incisions made through the scalp to expose the bone for trephining. Involved in this new addition to our knowledge of an ancient practice is a different way of looking at skulls that have been operated upon. The nature of the reorientation will be explained later and here it will be mentioned only that the rarity of specimens filling in certain parts of the surgical picture led the writer to seek verification in other undescribed collections. His quest took him first to the American Museum of Natural History in New York where he was enabled to study 23 skulls with artificial openings collected in the region of Lake Titicaca in the 1890's by A. F. Bandelier, and then to the Peabody Museum, Harvard University, where he studied 102 such skulls collected in the Central Highlands of Peru prior to 1912 by Julio Tello. Subsequently the writer saw a few more specimens at the British Museum (Natural History) in London and at the Musée de l'Homme in Paris. For courtesies received at these institutions he is indebted especially to Dr. Harry L. Shapiro, Dr. W. W. Howells, Dr. Kenneth Oakley, and Dr. Henry V. Vallois, respectively.

The present paper will give a broad summary of skull surgery as practiced in ancient times and among certain recent people still having a Stone Age culture. In the part dealing with the New World some of the new observations on the collections mentioned above will be presented. In addition, some new observations on putative examples of trephining from North America will be presented.

DISTRIBUTION

Europe.—The publicity that Broca gave to Squier's trephined skull from Peru led soon to the recognition of skulls showing evidence of surgery from the Neolithic period in France. It began with Prunières' report of 1873 (1874) of such specimens from the dolmens of Lozère in southern France and was followed by Broca's (1876) explanation of the perforations and the often accompanying rondels or

amulets of bone, and still later by Manouvrier's (1895) recognition of the nature of the "sincipital T"—a cross-shaped scarring of the skull vault resulting from cauterization—to mention only landmarks in the resulting extensive literature for Europe. Fortunately, it is no longer necessary to go back to this literature for answers to many of the questions that come to mind, because Piggott (1940) has summarized and interpreted the record in an admirable fashion. He has also listed most of the references for this area.



FIGURE 1.—Squier's famous Cuzco skull, the first recognized case of prehistoric trepanning. (Squier, 1877, p. 457.)

In brief, some 370 examples of the practice have been reported from the whole of prehistoric Europe, from Portugal in the southwest to Sweden in the northeast, and from England in the northwest to Czechoslovakia in the southeast (fig. 2). In time they range from about 3000 to 200 B. C. Judging from the concentrations of specimens and from archeological considerations, it would appear that a major surgical center developed in southern France about 1900–1500 B. C. and this led—perhaps through a cult—to the formation in late Neolithic times of a secondary center in the Paris area and also to much of the wide distribution noted. Very likely the ancient custom can be connected directly with the beginnings of modern European surgery.

Pacific.—It is not clear just when knowledge of the practice of skull surgery in the South Pacific reached the western world. In France

Hamy already knew about it in 1874 when Sanson summarized an article on the subject from the *Medical Times* for the Anthropological Society of Paris. Hamy could add that in his opinion the perforations made by the South Sea surgeons differed considerably from those made by Neolithic man in France. Thus, although the existence of the practice in the Pacific may have been known in Europe for some

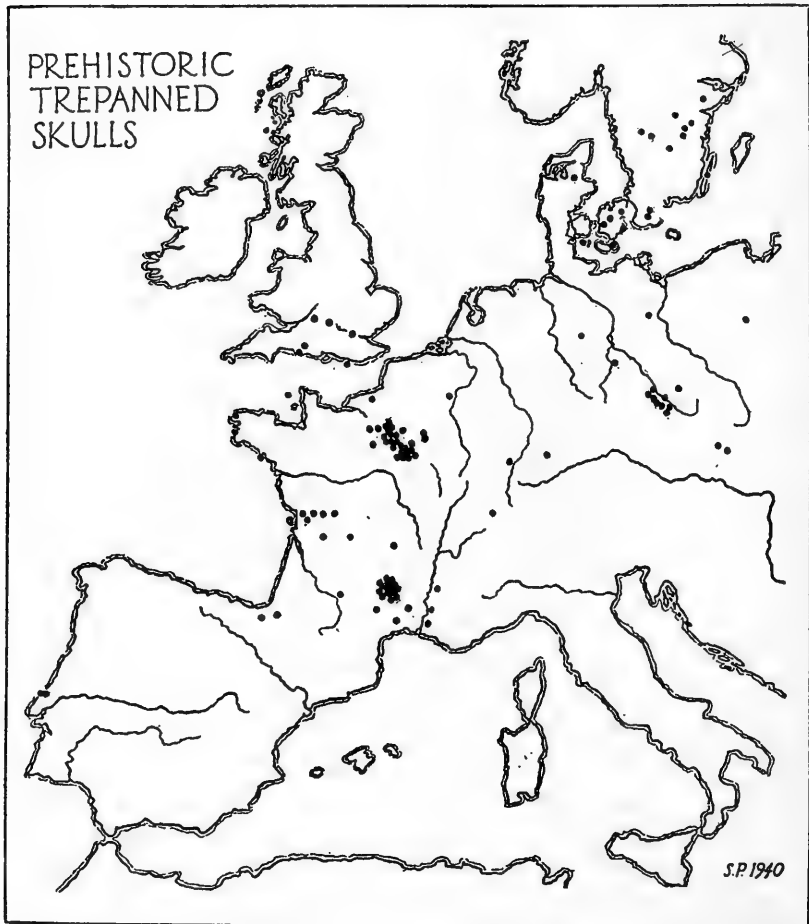

FIGURE 2.—Map of Europe showing 98 sites from which some 200 trephined skulls have been reported. (Modified from Piggott, 1940, p. 117, fig. 2.)

time, the fact that it was still continuing in this remote area seems to have been overshadowed by the current discoveries in Europe concerning the antiquity of the practice. Also, actual examples of trephining from the Pacific were slow in reaching Europe. In 1875 Lesson sent to Topinard some surgical instruments, said to be for trephining, which he had collected in Tahiti, but not until 1879 does it appear that

the Anthropological Society of Paris received a trephined skull—in this case from New Caledonia. (See Bull. Soc. Anthropol. Paris, 3^e sér., vol. 2, p. 719.)

Among the best summaries of the literature on skull surgery in the Pacific area are those by Wölfel (1925), Ford (1937), and Heyerdahl (1952). From these and other sources it appears that the practice centered mainly in Melanesia, particularly in the Gazelle Peninsula of New Britain, in the southern part of New Ireland and certain outlying islands, in New Caledonia, and in the Loyalty Group (fig. 3).

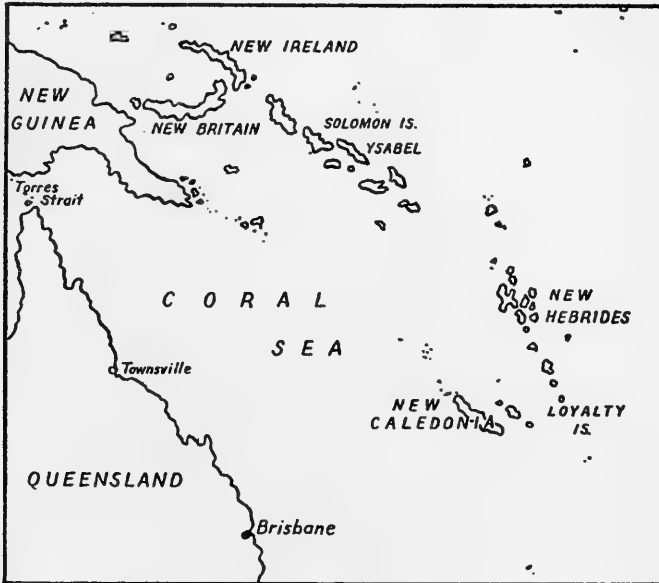

FIGURE 3.—Map of Melanesia showing the island groups where a primitive type of skull surgery was practiced in recent times. (Modified from Ford, 1937, p. 473, fig. 1.)

When we consider how much study has been devoted to Polynesia, the actual evidence for the existence of the practice there seems strangely disproportionate to the rumors. Heyerdahl (1952) made a special study of this and many other cultural features in developing the thesis of east-west transpacific migrations in prehistoric times. Except for three trephined skulls in museum collections (one each from the Marquesas, the Tuamotus, and New Zealand), his assembled evidence is largely hearsay. The skull from New Zealand (Wölfel, 1925) is suspect because it is grossly pathological (syphilis), and proof is not yet forthcoming that syphilitic gummata cannot leave healed openings resembling trephine openings in the skull. Doubts arise also from certain seeming errors in reporting. For example, Wölfel points out (p. 13) that Turner (1884) may have mistaken the name of the island Uvea (or Uea) in the Loyalty Group for the island with the

same name near Samoa and thus moved the practice far from its real setting. As for the surgical instruments from Tahiti sent to Topinard in 1875, referred to above, Topinard frankly admitted that he did not believe they were used exclusively for trephining and suggested that they might have been used for scarification, lancing, etc. Thus it is not easy to say whether Heyerdahl is correct when he concludes:

We have ample evidence to suggest that the Peruvians brought trepanning and its associates down-wind into the Pacific at an early period when Polynesia was still virgin land. The strongest evidence has survived on both sides of Polynesia, but although this latter intervening area has later been overrun by another immigrant stream, some islands . . . present sufficient evidence to show that the trepanation bridge formerly spanned the whole water from the coast of Peru to the islands in Melanesia. (P. 665.)

Nothing is known about time depth for the practice of skull surgery in the Pacific. The reliable records consist either of eyewitness accounts or actual skulls which had been operated upon in recent times. Even these skulls seem to be few in number, totaling, so far as can be judged from the literature, scarcely 100.

South America.—Following Squier's discovery of the first trephined skull in Peru, a long time elapsed before much more became known about skull surgery in South America. The next specimen to receive publicity was from Chacacayo, near Lima, Peru (Mason, 1885).¹ Surprisingly, in this case the opening in the forehead was said to have been made after death and it was stated further that all "examples of aboriginal trephining in America were more than probably *post mortem*" (p. 411). Doubtless this erroneous opinion reflects the controversy then in progress regarding certain North American skulls cut post mortem to obtain amulets (Fletcher, 1882; Gillman, 1876, 1885).

Not until 1897, when the Smithsonian Institution published the classic monograph by Muñiz and McGee on Peruvian trephining, did the world learn much more about the practice in Peru. Even after this, important contributions to the subject were slow in appearing (Tello, 1913; MacCurdy, 1923; Quevedo, 1943; Weiss, 1949; Graña et al., 1954). Yet it appears now that more trephined skulls have been found in Peru than in all the rest of the world together. If to this number are added skulls showing other types of surgical intervention, probably the total approaches 1,000.

Although Peru doubtless was the surgical center of South America, the practice was restricted largely to the central and southern parts

¹ Originally cataloged as No. 75961 in the Division of Ethnology, U. S. National Museum, it was subsequently transferred to the Army Medical Museum (now Medical Museum of the Armed Forces Institute of Pathology) where it now bears AFIP No. 287904.

of that country and to the neighboring part of Bolivia in the region of Titicaca. Within this general area, as in Europe and Melanesia, the surgical specimens have been found concentrated in certain places—for example, around Huarochirí in the Central Highlands,² at Paracas on the Southern Coast, and around Cuzco in the Southern Highlands. Very likely these concentrations reflect cultural patterns (Weiss, 1953).

The oldest skulls from Peru showing artificial openings or areas with the outer table scraped away probably are those from Paracas (ca. fifth century B. C. to fifth century A. D.). However, it is not clear that the Paracas specimens represent a surgical practice for therapeutic purposes. Although Tello states that bone regeneration is present in some cases (Stewart, 1943), in all those seen by the writer the cuts looked fresh. Perhaps, therefore, the trephined skulls of Paracas represent a phase of the locally well-developed head-trophy cult rather than true surgery. Elsewhere in Peru the custom appears to be much later, and even associated with the rise of the Incas.

Bolivian, and possibly also Peruvian, Indians continued to operate on living heads into post-Columbian times (Bandelier, 1904). However, very little reliable information has been recorded by eyewitnesses. A few pottery jars ornamented with representations of surgical scenes have been found (Morales Macedo, 1917; Vélez López, 1940), but these add little to our knowledge of the practice. It should be added, also, that on at least two occasions present-day Peruvian surgeons have operated on living heads with primitive implements obtained from ancient sites (personal communication from Sergio A. Quevedo in 1944; Graña et al., 1954). Since the ancient skulls had already proved that the operation could be accomplished by the use of such tools, it is difficult to understand why these additional demonstrations were undertaken.

North America.—Evidence for the practice of skull surgery in the New World outside of Peru has not been summarized recently and hence deserves extended consideration here. Reference was made above to Gillman's early descriptions of skulls with artificial openings from the State of Michigan in the United States. These cases usually have a small circular opening in the midline near bregma. In 1936 Hinsdale and Greenman showed that the distribution of such skulls includes the regions adjoining the State on the south and east. Although it was claimed almost from the beginning (Gillman, 1876) that these openings were made post mortem and were probably in-

² The collections obtained by Hrdlička in 1910 and 1912 for the U. S. National Museum and the San Diego Museum, and the collections obtained by Tello before and after 1912 and now in the Peabody Museum (Harvard) and the Museo Nacional d'Antropología in Lima, respectively, are mainly from this area.

tended for suspending the skulls, Hinsdale (1924) has claimed that one of them is an example of "real trephining" and that "the edges of the opening show unmistakable evidence of a well-advanced healing process, which could have gone on only during life" (p. 13). Hrdlička (1939) agreed with Hinsdale, as might have been expected, since he was one of the first to report a case of trephining from North America (Lumholtz and Hrdlička, 1897). Indeed, Hrdlička seems to have seen in many skull perforations, and even in some shallow depressions in the skull vault (Anonymous, 1935), widespread evidence of the practice of skull surgery. These and other cases, totaling 17, that have come to the writer's attention in the literature, are listed chronologically in table 1.³

Now, obviously, 17 (or 19, when Romero's other cases are included) is not an impressive number of cases of trephining to have been assembled in 60 years from the vast area stretching from Mexico to Alaska and across the United States from coast to coast. One is inclined to wonder, too, why only two cases have turned up in the Southwest among all the hundreds of skulls found there. On this point the writer noted in 1940, in presenting the case from Maryland, listed in table 1 (pl. 3), that—

this one is perhaps the most convincing example of [trephining] yet found in the northern continent. Yet as an example of primitive surgery it is singularly isolated among the hundreds of skulls from this site. It would seem unreasonable to expect such a successful end result on a first attempt at cranial surgery, but according to modern pathological knowledge no other diagnosis fits as well. (P. 16.)

It is difficult to describe the feeling of dissatisfaction with the evidence and arguments which one gains in reading the individual reports and in examining the accompanying illustrations. Some of the cases undoubtedly represent old healed injuries in which there was no surgical intervention; others are fresh openings which, since they could have been made after death, do not prove the existence of surgery in the real sense. Only two or three look anything like what is often seen in Peruvian specimens.

Twenty years ago the writer reexamined the first three cases from British Columbia listed in table 1. In none of these cases had objective proof of the findings, in the form of photomicrographs, been given. Herewith (pls. 4-8) this deficiency is corrected. Inspection of these plates should convince anyone that, with the exception of the larger opening in the Eburne skull, evidence of healing is lacking or

³In a paper read at the reunion of the Mesa Redonda of the Mexican Anthropological Society in Oaxaca in September 1957, Javier Romero summarized five cases of trephining from Monte Albán, including one case from the Mixteca and presumably the three cases listed here. When this paper is published, two more cases can be added to those in table 1.

very doubtful. Histological study is needed here, as well as in some of the other cases, to distinguish true healing from the surface smoothing resulting from a cord passing through the opening.

From all these considerations the writer is inclined to be skeptical about most of the cases cited being examples of real trephining. Although healed openings such as occur in the Eburne and Accokeek skulls look real, their isolation in large skull collections argues strongly in favor of a natural process rather than surgery. Especially significant is the absence of cases showing bone infection around the opening or, in other words, showing survival for a short time following an operation in life.⁴

Africa.—The practice of skull surgery is not known to be represented in the whole of the continent of Africa, except at two points very close to western Europe: (1) Among the Kabyles in the Djebel Aurès (Mount Aurès), in the province of Constantine, in Algeria (Malbot and Verneau, 1897); and (2) on the island of Tenerife in the Canaries (Beattie, 1930). In Algeria, where the practice has persisted into modern times, trephined skulls have been found in archeological settings antedating Roman times. How much further back in time the custom goes, and whether it is entirely independent of Europe, is not known. In Tenerife the existence of the custom is known from at least 11 trephined specimens of uncertain age and probably over 30 others with bregmatic scars possibly indicating cauterization.

Drennan (1937) has tried "to demonstrate that the trepanation cult was also practiced in a primitive form by the Bushman race" in South Africa. However, his examples are not impressive, and look more like healed wounds than surgery.

Asia.—In 1897 Zaborowski reported to the Anthropological Society of Paris that the inhabitants of Dagestan, just west of the Caspian Sea, practiced a form of cauterization of the vertex of the head, somewhat like the sincipital T, in order to prevent illness. According to Guiard (1930), these people also practiced trephining for all sorts of circumstances as late as the end of the nineteenth century. Whether the practices here connect back with that of the Neolithic period in Europe is unknown.

For a long time Dagestan was the only place where skull surgery was known to have existed in Asia. Then in 1936 Starkey and Parry reported the recovery of three trephined skulls from a seventh-century B. C. ossuary at Tell Duweir in Palestine. Amazingly, two of the

⁴The writer has a picture of the first female skull from Monte Albán which shows a sinuous excavation surrounding the circular, steep-sided opening. The specimen needs to be examined again to see whether this line represents bone infection following operation. If indeed infection, the practice of skull surgery would have considerable time depth in Mexico—at least to 700-1000 A. D.

TABLE 1.—Cases of putative trephining from North America (listed in chronological order)

| Geographical location | Skull | | | | Surgical area | | | |
|---|-------|-------------|-------------------|-----------------------|----------------------------|----------|---|---|
| | Sex | Age | Condition | Position | Shape and size | Walls | Signs of instrument | Signs of repair |
| State of Chihuahua, Mexico ¹ | F | Over 60 | Compl. | Ant. rt. par. | Round: 2 cm. diam. | Vertical | None | "... walls of the opening are quite smooth and are covered with a compact bony tissue... smooth and slightly sunken external edge..." |
| " | F | About 50 | " | " " | Oval: 16 x 22 mm. | Beveled | " | "... almost filled with new bone..." |
| Boundary Bay, British Col.-Wash. ² | F | 40-50 | Damaged | " " | Oval(?): 5 cm. long | " | "... No secondary cuts about the aperture" (cf. pls. 4 and 6) | "... so smooth as to be nearly compact..." |
| " | F | 60 | " | Lt. frontal | Nr. round: 18-20 mm. | Vertical | ? | "... smoothing and in one spot compacting of the cut surface..." |
| Alpena Co., Michigan ³ | M | Young adult | Calva | Midline behind bregma | Oval: 12-21 mm. | " | ? | "... to be seen all over the cut..." (Hirdlicka) |
| Mitten Rock, New Mexico ⁴ | ? | Adult | Nr. compl., path. | Rt. frontal | Nr. round: 4 x 5 cm. | " | "... no marks of the instrument beyond the sharply defined edges of the opening itself." (Shapiro.) | None |
| Lamy, New Mexico ⁴ | ? | Adult | Damaged | Post. rt. par. | Diamond shaped: 2 cm. long | Beveled | None | "... borders of the opening show electrization, the cancellous tissue being entirely covered over by the growth of new and compact bone, and the inner table reveals... several fine spicules of new bone growing into the opening." (Shapiro.) |
| Columbia Co., Georgia ⁵ | M? | " | Frag. | Midpar. region | Round: 38 mm. diam. | " | "... around the inclusion the marks of the flint knife can be clearly seen." | "... external table is markedly electrized and the internal table shows healing at certain points, as does also the diploë." |

| | | | | | | | | |
|--|----|--------------|------------|---|---|---|--|---|
| Eburne, Brit. Columbia ⁵ | M | Young adult | Compl. | 1. Super. occ. 2. Rt. par. occ. | Round-oval: Ext.: 4 cm. in diam. Int.: 19 x 26 mm. Oval: Ext.: 13 x 22 mm. Int.: 2 openings, 4 and 2 mm. diam. resp. | Mostly bevel, pt. undercut Pt. bevel, pt. undercut | None (cf. pls. 7 and 8) " . . . Scratches made by a cutting instrument are to be seen on the walls . . . no marks on the skull surface about the opening. . . ." (cf. pls. 7 and 8) | " . . . shows evidence of healing . . ." None |
| Kodiak Island, Alaska. ¹ | M | Adult | Compl.? | Midpar. region | Elongated "cavity," 2 in. long, ½ in. wide. Inner table not perforated. | Beveled | ? " . . . healed perfectly . . ." | |
| Monte Albán, Mexico. ³ | F | 35 | Nr. compl. | Lt. front. | Round: 18.5 mm. in diam. | Vertical | ? | None |
| " " | M | 50 | " | Post. midparietal | Elliptic: Ext.: 21 x 24 mm. Int. 13.5 x 15.6 mm. | Beveled | ? | " . . . la superficie de la perforación denota francamente la tendencia regeneradora ósea." "Much erosion and healing occurred between the time of operation and death." Healed |
| Eastern Arkansas ⁴ | M? | Adult | Compl. | Lt. parietal | Oval (?) | " | None | |
| Acookeek, Maryland ² | M | Mid. age ad. | Incompl. | Rt. parietal | Triangular: 19 x 24 mm. | " | None (cf. pl. 3) | |
| Sheena River, Brit. Columbia ¹¹ | M | Adult | Compl. | Lt. frontal | Circular: 1½ in. diam. | " | None | "Healing . . . was complete with no sign of infection." "Healing was effected with but little infection. . ." |
| Lytton, Brit. Columbia ¹¹ | F | " | " | 1. Vertex | Circular: 2 in. diam. (actually 2 semicircular areas) | " | None | |
| | | | | 2. Lt. pariet. | Scraped area roughly 2 in. long and 1 in. wide. | " | " . . . marks . . . are still visible in two or more places." " . . . puede apreciarse una serie de estrías aparentemente producidas por un instrumento. . . ." | " . . . completely healed. . ." |
| Monte Albán, Mexico ¹² | F | " | Compl.? | Mid parietal region, on sagittal suture | Circular: 72 mm. in diameter. | " | None | |

¹ Wakefield and Dellinger, 1936, 1939.

² Stewart, 1940.

³ Leechman, 1944.

⁴ Romero, 1952, footnote 19.

⁵ Cosgrove, 1929.

⁶ Kidd, 1930.

⁷ Anonymous, 1935.

⁸ Romero, 1935.

¹ Lumbholtz and Hrdlička, 1897.

² Smith, 1924.

³ Hinsdale, 1924; Hinsdale and Greenman, 1936; Hrdlička, 1939.

⁴ Shapiro, 1927; Moodie, 1930.

artificial openings had been made in the same rectangular fashion as that in the original Squier specimen (fig. 1). Since there are indications of osteitis about one of these rectangular openings, probably the individual briefly survived his operation. The third case probably represents a healed decompressed fracture. It is noteworthy also that all three Palestine cases were culled from a collection of several hundred skulls, which suggests that skull surgery was not practiced very often in this locality.

MOTIVES FOR OPERATING

A skull which has been operated upon seldom by itself tells why the operation was undertaken. It is owing to this fact that most explanations of primitive skull surgery include the word "thaumaturgy"—magic, from the Greek word for wonderworking. Doubtless a large element of mysticism became involved in such operations in the course of time, but whether or not it led to, or grew out of, a therapeutic measure, is debatable. For example, McGee (1897), evidently influenced by the discoveries in Europe and North America of amulets and human skulls cut post mortem, maintained that "trephining began . . . and was performed after death for the purpose of obtaining amulets. It . . . was gradually extended to living captives for the same vicarious purpose." (P. 72.) From this beginning McGee saw the procedure tied in more and more with "incantations . . . accompanied by medication or manipulation." Then, according to this reconstruction of events, whenever the procedure proved beneficial, an otherwise aimless operation tended to grow into empiric surgery. Other writers on this subject, who have not been impressed by the role of amulet collecting, have felt that traumatic and/or pathological indications requiring therapy first induced primitive man to cut into the head. Tello (1913) listed four such indications, foremost of which was fracture of the skull. On the other hand, Ford (1937), speaking for Melanesia, where, as in Peru, warfare resulted in many skull fractures, reconstructs events as follows:

The operation was undertaken for the immediate treatment of traumatic cranial injuries, and in certain areas its performance was extended to the treatment of severe headache and other ailments, and as a prophylactic measure, in children, against the occurrence of such affections in subsequent life. (P. 477.)

Besides cutting through the skull, primitive surgeons in certain areas, as we have seen, produced extensive scars on the skull vault, some of them in the form of a cross (sincipital T). So far as Europe is concerned, the nature of this practice is clear from surviving medieval medical records (MacCurdy, 1905): chemical or thermal cauterization was applied as a counterirritant in cases of dementia and epilepsy. This does not mean that any large bone scar need be

interpreted as having been caused by cauterization, as Moodie (1921) and Weiss (1955) seem to imply. Any damage to the scalp leading to loss of blood supply to the bone followed by osteitis can end in bone scarring (Stewart, 1956).

From these considerations it is understandable that similar appearances of perforated and scarred skulls from widely scattered places may hide variations in surgical motivations. Almost certainly the alleviation of pressure on the brain caused by skull fracture was the most frequent reason for the operation in Peru and Melanesia; it may have been the reason less frequently in Europe. Probably in Peru, as in Melanesia, the operation was undertaken for additional reasons, otherwise it is difficult to explain why the individual whose skull is shown on plate 1 would have had his head opened seven times. Just what these reasons were in Peru, whether headaches, epilepsy, or dementia, is not known.

Operations on the head to obtain rondels or amulets seem to have been restricted mainly to Europe. These round pieces of skull, often polished and sometimes perforated for suspension, have been found in burials there and sometimes accompanying surgically opened skulls. In these European examples apparently it was important that the rondel include a bit of healed edge from a previous operation, thus assuring to the possessor some quality connected with the operation.⁵ Judging from certain European skulls in which signs of altered growth accompany healed openings, Broca (1876) concluded that the operation often was made in infancy. Perhaps, therefore, the practice was somewhat comparable to that in Melanesia where, according to Ford (1937), women cut openings through the foreheads of some of the children, 3 to 5 years of age, to ward off future trouble from trauma; in other words, the European custom may have been an extension of a surgical procedure from therapy to prophylaxis.

The Peruvians also operated on children. The United States National Museum collection includes the skulls of three children close to 6 years of age and three near 12 years of age. Only two of these, including an incomplete specimen, lack a clear sign of fracture. The Tello collection at Peabody Museum, Harvard University, includes the skulls of 4 children close to 6 years of age and 11 around 12 years of age (another lacks the face and hence the age is uncertain). Signs of fracture are evident in seven of these. Plate 9

⁵ In 1899 Thomas Wilson, then curator of prehistoric archeology in the U. S. National Museum, prepared an extensive manuscript on "Prehistoric Trepanned Skulls," which includes summaries of most of the European finds to that date. Wilson had seen many of the original specimens and had even helped recover some of them. This manuscript, which is now in the division of physical anthropology, has been of help in preparing the present paper.

(upper left) shows the skull of a child, whose permanent first molars were just beginning to erupt, in which two trephine openings are visible, but no sign of fracture, unless it be the little crack in the temporal squama extending down from the smaller opening. This is an example of how difficult it is sometimes to find the surgical motivation.

SURGICAL TECHNIQUES

The striking feature about Squier's Cuzco skull, as mentioned in the beginning, is the rectangular pattern of canoe-shaped cuts (fig. 1). Only three skulls with cuts of this type are known outside of Peru—one from France and two from Palestine. In Peru such skulls have been found mainly in the Central Highlands. By their nature these cuts are deeper at the middle than at either end and hence when they penetrate the skull in a rectangular pattern the piece of bone that is freed is much smaller than the total area involved in the cutting. This means that the primitive surgeon who used this technique had to cut the scalp in such a way as to expose much more of the skull vault than he intended to open. One of the dangers here was that the large area of exposed bone would lose the blood supply normally received through the scalp and that the ischemic bone would become infected. Obviously, then, the ancient surgeons in Peru and elsewhere who operated in this way were using a technically unsound procedure.

Just as obviously the technique used in cutting the seven holes in the skull shown in plate 1 must have been efficient; it enabled the individual to survive each successive operation with a minimum of post-operative bone scarring. When circular holes were to be made, apparently very little more scalp was removed or turned back than was needed for the opening in the bone. Other examples show that the bone was cut and/or scraped in a circular fashion so as to produce a beveled edge. It is not clear how often a button of bone was removed or how often the bone simply was scraped away over the whole area of the opening. In general, this technique, with one or other of its variants, was favored wherever trephining was practiced in ancient times.

Trephining by drilling small holes in a circular pattern and then cutting the slender connections between them, as illustrated in plate 2, probably was not practiced outside of Peru and only occasionally in Peru. Failure to use this technique more often may have been due to fear that the tip of the drill would damage the brain.

In making their incisions through the scalp and in effecting an opening in the skull, without the use of general anesthetics, primitive surgeons relied on the sharp edges of flaked stones, especially flint and obsidian. In Melanesia the shark's tooth also was used as a cutting instrument. When metals became available they were made into

surgical tools, but for a long time these new tools lacked the necessary hardness and sharpness. Probably accessory objects of perishable materials, such as wood, cloth, etc., were used also, but little, if anything, is known about them, except in areas where the practice has persisted.

Like the surgeons' implements of perishable materials, the soft parts covering the prehistoric skulls have disappeared where they have not mummified. On page 470 the writer mentioned his earlier demonstration of the fact that the extent of the openings of the scalp made by ancient Peruvian surgeons prior to opening the skull sometimes is still imprinted, so to speak, on the bone (mainly in connection with rectangular trephine openings). This record is due to the fact that in Peru the surgeons often removed the scalp completely over the area where they planned to trephine, and in so doing they made their incisions in an angular pattern so that the opening in the scalp had three to five or more sides (but commonly only four). The imprinting of this event on a skull could come about in several ways: Postoperative bone infection could begin at the margins of the wound where the blood supply was cut off and gradually undermine the exposed outer table; or the infection could clear up and new bone form with a pattern of scarring conforming to the preceding pattern of infection; or, in the event the patient died during the operation, the soft parts could mummify, leaving the bone exposed by the surgeon to be discolored differently from that covered by scalp (either darkened by chemical dyes or bleached by sunlight). Plates 9 and 10 illustrate clearly these alternatives (see also figs. 3 and 5 in Stewart, 1956). No longer is it sufficient to look at the trephine openings alone; all the surrounding bone must be inspected for clues as to what happened. For example, plate 9, lower left, shows one of many cases of surgery on the forehead in which the incisions through the scalp were in a diamond-shape pattern with long axis running anteroposteriorly. Probably this shows a knowledge of the tensions in the scalp.

In the fairly large number of Peruvian cases where death occurred during or immediately after the trephining, and the soft parts did not mummify, there is, of course, no way of knowing the size of the opening in the scalp. However, accidental cut marks on the bone beyond the limits of the opening sometimes suggest where the scalp incisions were placed. Again, in the fairly large number of cases where bone healing followed trephining without leaving much scarring and certainly no angular pattern of scarring, it is assumed that the edge of the scalp opening was near the edge of the opening in the bone, or possibly small scalp flaps were replaced over the opening. Perhaps such a technique was used in Europe in ancient times. In Melanesia the skin flaps were replaced and then stitched (Ford, 1937).

Nothing is known about the postoperative care of the surgical area in prehistoric times. It is sometimes stated that a shell or metal disk was placed over the hole in the skull, but there is no good evidence of this practice. Hrdlička (1939) illustrated a partly mummified head from the Nasca region of Peru with what he interpreted as a surgical bandage still in place over the rear parts. However, X-rays now show that this head had not been trephined and nothing else about the head itself suggests that this so-called bandage was connected with a surgical procedure. On the other hand, the writer has presented arguments (1956) supporting the possibility that the patterns of osteitis and bone scarring to which he has called attention (see also pls. 9 and 10) were due to chemical irritants used in postoperative treatments. In spite of this, the writer is inclined to favor septic osteitis rather than chemical osteitis as the explanation of these features.

In contrast to the paucity of information on postoperative procedures in ancient times, numerous observations made directly on patients have been reported from Melanesia. From the data which Ford (1937) has assembled it seems that in the Gazelle Peninsula "the hole formed at operation was plugged with a piece of native bark cloth." Here also it is reported that "before the scalp flaps were replaced the opening in the skull was covered with a piece of the inner bark or inside leaf of the banana palm, which had been held for a short time over the coals of a fire." In the Loyalty Islands cocoonut shell was used instead of bark. In these islands also "The scalp was stitched with a needle made from the wingbone of a flying fox, and some of their own twine, which is fine and strong." And finally, after the scalp flaps were replaced, it was the custom in the Duke of York Group (north of New Britain), to bind the head with sun-dried strips from the banana stalk. Ford adds (p. 474) that "the water of the unripe cocoonut was used to wash the wound, and, in some cases, the hands of the operator. This, since sterilization by heat was not understood, provided the only relatively bacteria-free fluid available." This pieced-together picture of postoperative procedures may approximate a custom that was common throughout Melanesia.

Ford implies that when the fracture cases were operated on the patients were unconscious. This may have been true of most cases of this sort everywhere. Even in Peru, where the cocoa leaf was chewed for its narcotic effect, it is not certain how far this principle was applied as a part of the surgical procedure.

SITES OF OPERATION

No part of the skull vault was immune to surgery, although naturally the primitive surgeons did not go very deep under the temporal and occipital muscles. Almost everywhere the left side of the skull seems

to have been the most common site of operation. This may have been associated with warfare and the delivery of blows to the head by right-handed adversaries. In a series of 112 operations studied by the writer in the Tello collection in the Peabody Museum, 48.2 percent are on, or largely on, the left side, as compared with 29.5 percent on, or largely on, the right side, and 22.3 percent in the midline. The further distribution of these operations is shown in table 2. According to these findings, the front of the skull received most attention. Again, this would be an area vulnerable in warfare.

TABLE 2.—*Distribution of trephine openings in Peruvian skulls (Tello collection, Peabody Museum, Harvard University)*

| <i>Location</i> | <i>Number of cases</i> | <i>Percentage</i> |
|---|------------------------|-------------------|
| <i>Frontal area:</i> | | |
| Frontal bone..... | 26 | } 60----- 53.6 |
| Crossing right coronal suture..... | 9 | |
| Region of bregma..... | 12 | |
| Crossing left coronal suture..... | 12 | |
| Extending from frontal to temporal..... | 1 | |
| <i>Parietal area:</i> | | |
| Right parietal bone..... | 3 | } 37----- 33.0 |
| Crossing sagittal suture..... | 15 | |
| Left parietal bone..... | 18 | |
| Extending from parietal to temporal..... | 1 | |
| <i>Occipital area:</i> | | |
| Occipital bone..... | 4 | } 15----- 13.4 |
| Crossing right lambdoid suture..... | 2 | |
| Region of lambda..... | 7 | |
| Crossing left lambdoid suture..... | 1 | |
| Extending from occipital to temporal..... | 1 | |
| Total..... | 112 | |

If the ancient surgeons knew of the danger of hemorrhage from entering the sagittal and transverse venous sinuses, table 2 shows that they were not deterred from cutting through the bone in these areas (see also pl. 1). Neither were they deterred by the danger of infection from operating on the frontal sinuses, although operations at this point are not very common. Moodie (1929) illustrates some cases and there is another in the United States National Museum collection (No. 293795, Cinco Cerros). In the latter a fracture had involved some of the facial bones and the frontal bone above the right orbit. In making a trephine opening above the right orbit probably the frontal sinus was encountered. Be this as it may, before healing finally took place there was extensive scarring of the accessory nasal sinuses from infection.

A word should be said about the efforts of the Peruvian surgeons in some cases to follow outlines of fracture. There is a remarkable

example of this in the Tello collection, Peabody Museum (identified simply by the letter "A," but probably in the Ll. series), consisting of a mummified head which had received a large comminuted fracture on the left side of the occiput. Apparently the surgeon had taken out the loose pieces of bone, leaving an irregular hole 46 mm. long and 31 mm. wide. Then he had followed one of the fracture lines forward to the coronal suture, turning back the soft parts and cleaning the bone (as evidenced by the still displaced tissues and by scratches on the bone). This was bold surgery. Had the patient lived, his skull would have shown widespread scarring.

Piggott (1940, p. 122) says that in Europe "there . . . appears little evidence for any regional predilection." However, he notes that "The commonest region trepanned seems the parietal, and there is perhaps a tendency for the left side to be preferred" (p. 123). He adds that "there is a curiously high proportion of frontal operations in the Czechoslovak group and it occurs again at Grydejöj in Denmark" (pp. 122-123).

In Melanesia the frontal bone seems to have been the site of election for the prophylactic operations made in infancy (Ford, 1937). So far as adults are concerned, the distribution of sites may well follow the Peruvian pattern, since in both places most of the skull fractures were received in warfare.

OUTCOME OF OPERATION

It should be clear from what has been said, as well as from the illustrations given, that trephining was practiced in ancient times, and recently by peoples in a primitive stage of culture, with a considerable degree of success. Fairly reliable data on this subject are available for Peru, owing to the large number of specimens that have been assembled from there. For example, by combining the 214 operations seen by the writer in the collections of the U. S. National Museum, the American Museum of Natural History, and the Peabody Museum, 55.6 percent show complete healing, 16.4 percent beginning healing, and 28 percent no healing. Others have reported similar figures (Stewart, 1950).

For the Neolithic period of Europe Piggott (1940, p. 122) says simply that—

the proportion of survivals from this operation . . . is extremely high, as is evidenced by skulls showing the healthy growth of new bone around the edges of the opening, nor is it unusual for one skull to exhibit evidence of two or more operations all with healed edges.

Cases of repeated successful operations on the same individual are known also from Melanesia. For this area Ford appears to subscribe to the high estimates of recoveries given by several authors. One figure he mentions is "about 80 percent," and here emphasis is placed

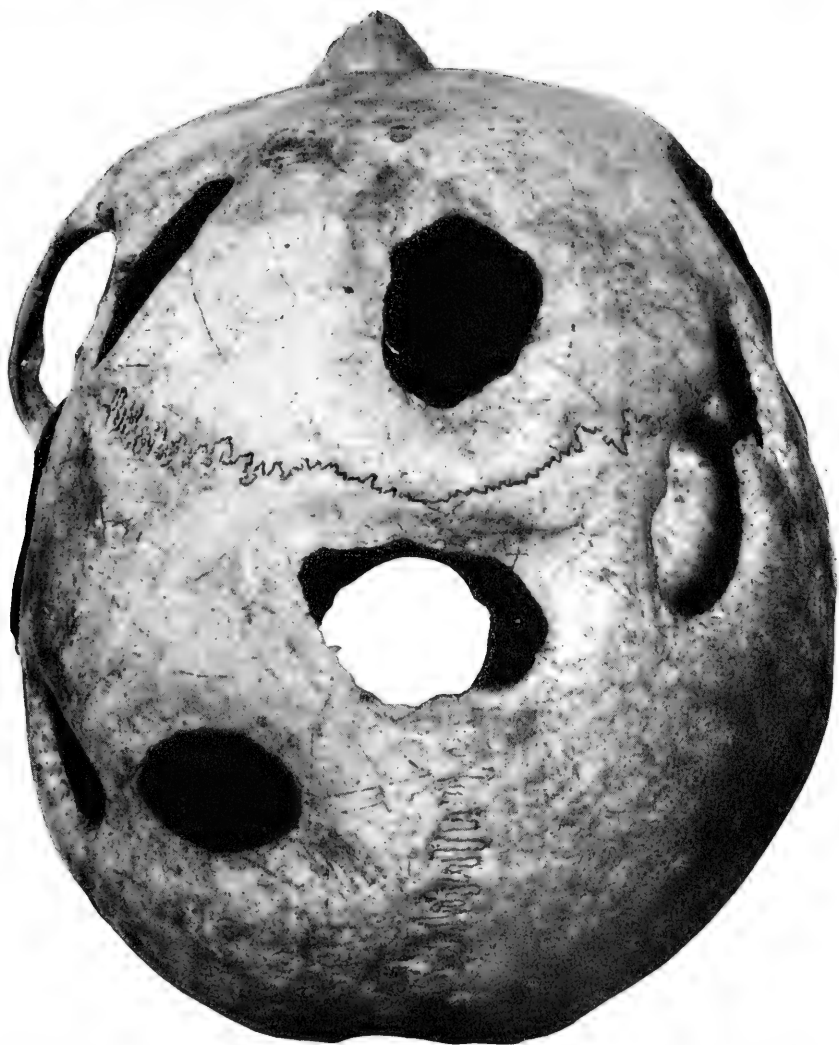

Skull from Cuzco, Peru, with seven circular healed trephine openings. British Museum (Nat. Hist.) No. 1956.10.10.1. (Photograph courtesy of Kenneth Oakley.)

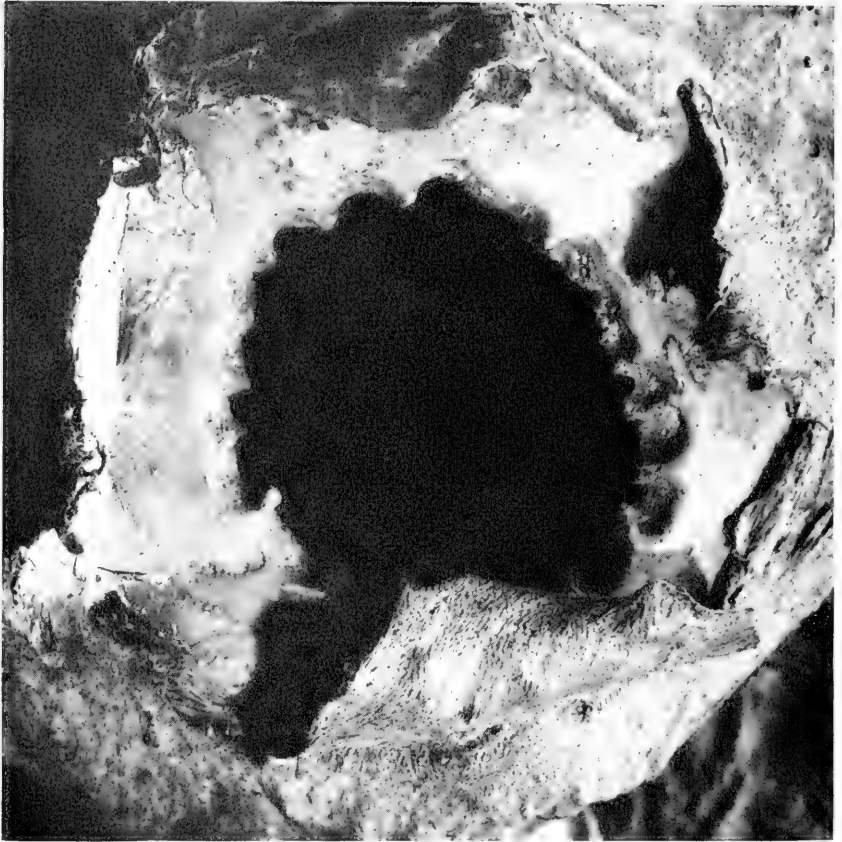

Head of a Peruvian mummy with a large trephine opening in the left parieto-occipital region made by the drilling technique. The opening is 57 mm. long and 43 mm. wide and thus may be the largest on record made in this way. The scalp has been turned back to expose the opening; it appears to have been cut into three or four flaps by radiating incisions. Musée de l'Homme No. 79-1-22, Utcumbamba, Piedra Grande. (Photograph courtesy of Henri V. Vallois.)

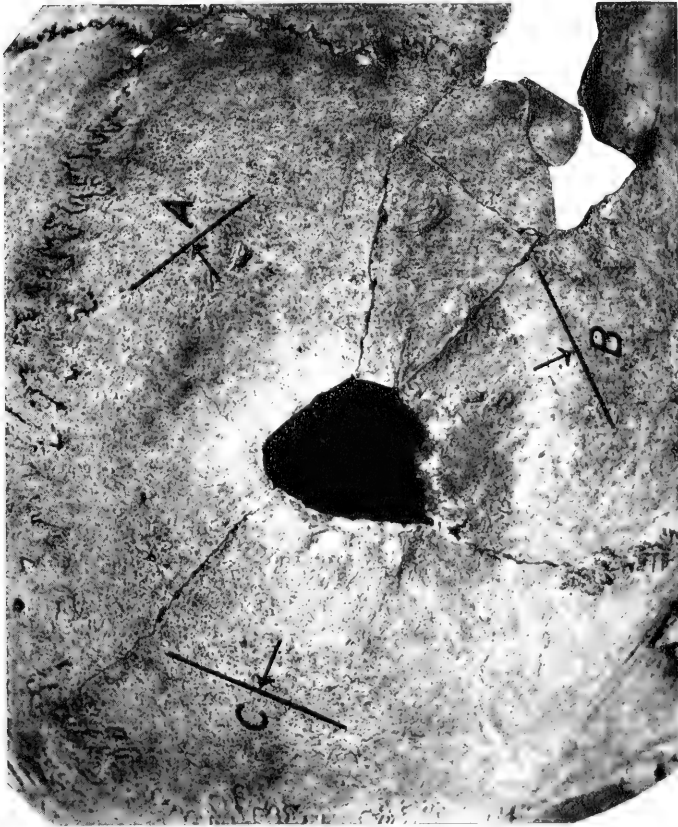

A

B

C

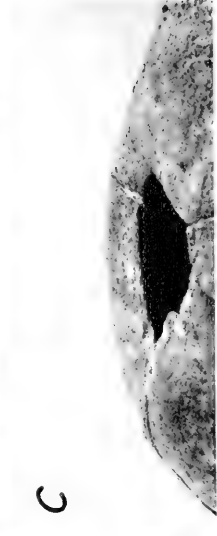

Left: Healed triangular-shaped opening in the mid right parietal of a skull (U. S. N. M. No. 379620) from the late Alice L. Ferguson's ossuary No. 4 at Accokeek, Md. (Stewart, 1940.) *Right:* Three views of the edges of the same opening, the directions being identified in the view to the left by the letters *A*, *B*, and *C*, and by arrows. This specimen has not been illustrated before.



Upper: Circular opening in left side of frontal bone of skull XII-B-1555 from Boundary Bay, British Columbia-Washington, described by Smith (1924). *Lower:* Oval opening (partly broken away) in right parietal of skull XII-B-1556 from the same source. (Photographs courtesy of National Museum of Canada.)

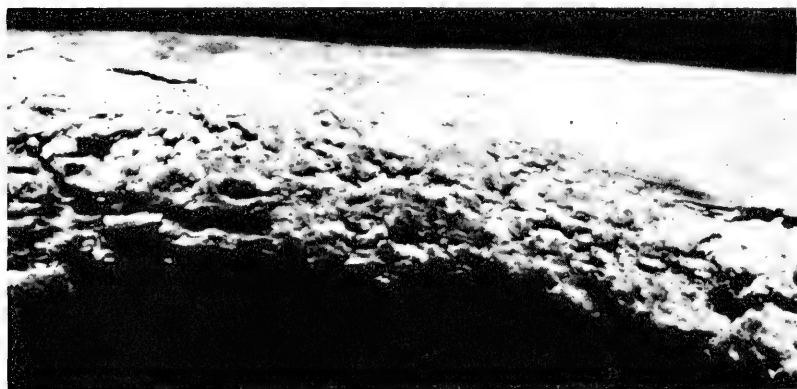
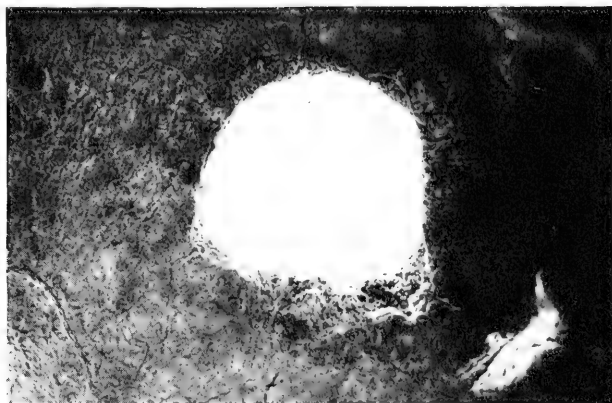

Upper: View of inside of skull XII-B-1555 from Boundary Bay, British Columbia-Washington, showing broken edge of circular opening. *Middle:* Photomicrograph of portion of edge of same opening. Note that there is smoothing but not obliteration of the inner bone structure. *Lower:* Photomicrograph of portion of outer surface around edge of opening. Note cut marks. (Photograph courtesy of National Museum of Canada.)



Upper: Photomicrograph of portion of edge of oval opening in skull XII-B-1556 from Boundary Bay, British Columbia-Washington. This portion of the opening is located at the upper left of the view in plate 4, lower. Note open diploë and striations on outer table. *Lower:* Photomicrograph of another part of the edge in the same opening. This portion of the opening is located at the top of the view in plate 4, lower. Note open diploë and striations in triplicate suggestive of rodent tooth marks. (Photograph courtesy of National Museum of Canada.)



Rear view of skull No. 33 from the Eburne shell mound in British Columbia showing two artificial openings described by Kidd (1930). (Photograph courtesy of City Museum of Vancouver.)

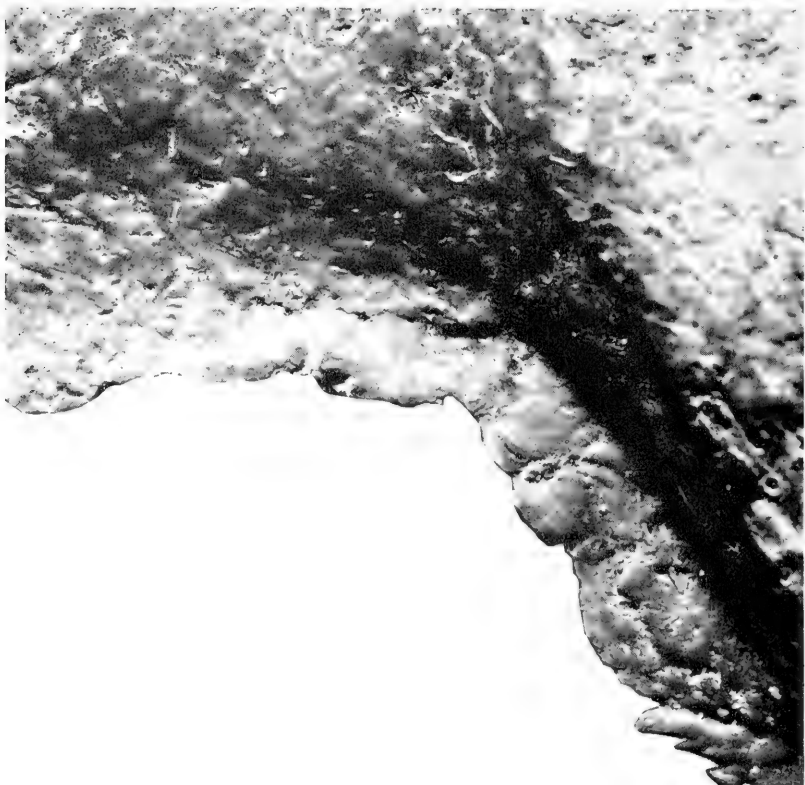

Upper: Photomicrograph of a section of the edge of the smaller opening in skull No. 33 from Eburne, British Columbia. Note cut marks. *Lower:* Photomicrograph of the outer surface at the right-inferior edge of the larger opening in the same skull. Note that the inner bone structure has been obliterated by the healing process. (Photographs courtesy of City Museum of Vancouver.)



Skulls showing evidence of surgical openings through scalp and bone. *Upper left:* Child (near 6 years). Lines of porosity above and behind the openings mark beginning of osteitis. (Tello coll. No. A 15.) *Upper right:* Young adult male. Surrounding rectangular area crosses sagittal suture and is bordered with beginning osteitis. (Tello coll. L1 9.) *Lower left:* Adult male. Surrounding diamond-shaped area of osteitis has outer table of bone sluffed off. (Tello coll. No. P 5.) *Lower right:* Adult male. Diamond-shaped area of scarring surrounds healed opening and triangular area edged with beginning osteitis surrounds fresh opening. (Tello coll. No. C1 1.) (Photographs courtesy of Peabody Museum, Harvard University.)

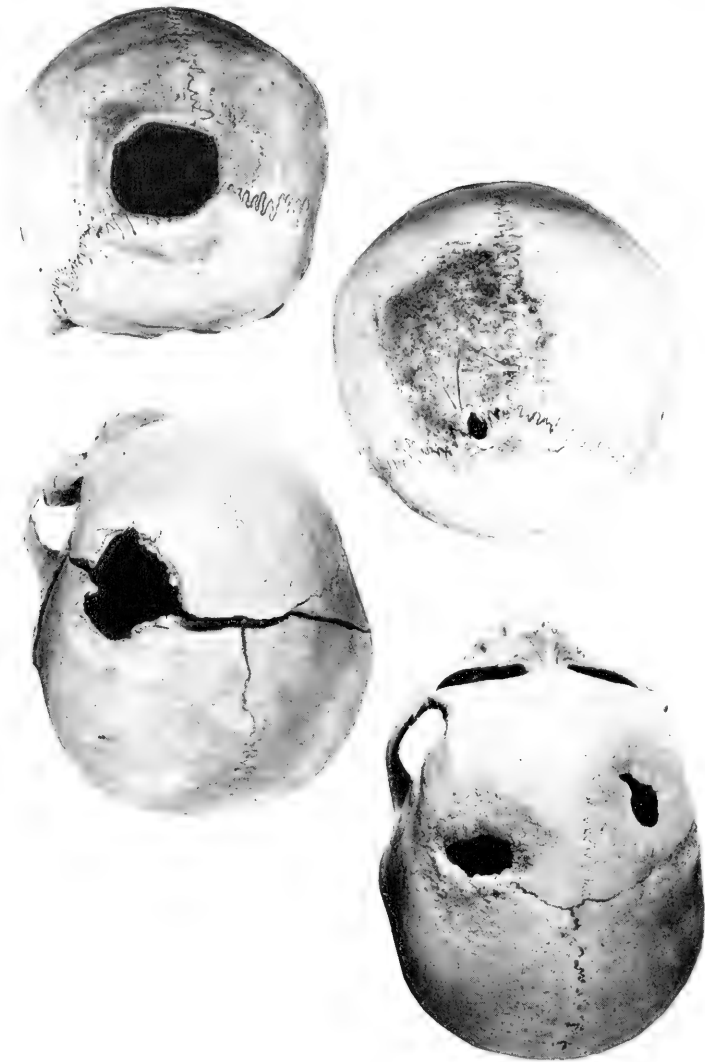

Skulls showing evidence of surgical openings through scalp and bone. *Upper left:* Adolescent male. Rectangular area of discoloration is edged with beginning osteitis. (Tello coll. No. A 7.) *Upper right:* Adult female. Rectangular area of discoloration is edged with beginning osteitis. (Tello coll. No. Sak. 8.) *Lower left:* Adult male. Large angular area of bleaching surrounds opening. (Tello coll. No. P 14.) *Lower right:* Adult male. Diamond-shaped area of scarring surrounds each opening. (Tello coll. No. H 41.) (Photographs courtesy of Peabody Museum, Harvard University.)

on the fact that the deaths were from the original injuries and not from complications after the operations. This amount of success may well be exaggerated, but it was certainly good enough to perpetuate the custom.

CONCLUDING STATEMENT

In this review of our present knowledge of Stone Age skull surgery many details necessarily have been omitted. Yet enough facts have been presented to show that a great deal has been learned about this subject since Squier returned from Cuzco with the first example of primitive trephining. Indeed, by its bulk this knowledge tends to create the impression that skull surgery was all of primitive surgery. That this is not true will be seen by referring to Ackerknecht's (1947) review of primitive surgery as a whole. Yet the fact remains that more is known about Stone Age man's operations on the skull than on any other part of the body. Piggott (1940, p. 114) explains this situation as follows:

[the] apparent isolation [of trephining] in the prehistory of surgery may be entirely accidental, due to the fact that the skull alone occupies a virtually exoskeletal position in relation to a vital organ, and in consequence any operational approach to the brain must be made through the bone of the skull—an enduring substance in the archaeological record.

Our knowledge of early operations on the skull tends also to give the impression that the primitive surgeon was more daring in his approach to the brain than the modern surgeon. This impression is minimized by considerations which again have been nicely stated by Piggott (p. 114):

The trepidation with which we approach the cerebral operation today is conditioned by our realization of the overwhelming importance of the brain in the vertebrate anatomy, a fact but dimly appreciated until comparatively recent times. It was not so long ago that, in both popular and professional regard, the heart was the seat of courage, the spleen of anger, and that the salient mental characteristics of the individual were located in the various viscera. Small wonder if prehistoric man approached trepanning in the same matter-of-fact way and upon a similar misconception as to the localisation of physiological activities.

LITERATURE CITED

ACKERKNECHT, ERWIN, H.

1947. Primitive surgery. *Amer. Anthropol.*, n. s., vol. 49, pp. 25-45.

ANONYMOUS.

1935. Alaska Indians had brain surgeons 2,000 years ago. *Sci. News Letter*, vol. 28, p. 377.

BANDELIER, ADOLPH F.

1904. Aboriginal trephining in Bolivia. *Amer. Anthropol.*, vol. 6, pp. 440-446.

BEATTIE, JOHN.

1930. A note on two skulls from Tenerife. *Amer. Journ. Phys. Anthropol.*, vol. 14, No. 3, pp. 447-449.

BROCA, PAUL.

1867. Cas singulier de trépanation chez les Incas. *Bull. Soc. Anthrop.* Paris, 2^e sér., vol. 2, pp. 403-408.

1876. Sur la trépanation du crâne et les amulettes craniennes à l'époque néolithique. VIII Congr. Intern. Anthrop. et Arch. préhist., Budapest, p. 101-196.

COSGROVE, C. B.

1929. A note on a trephined Indian skull from Georgia. *Amer. Journ. Phys. Anthrop.*, vol. 13, pp. 353-357.

DRENNAN, M. R.

1937. Some evidence of a trepanation cult in the Bushman race. *South African Med. Journ.*, pp. 183-191.

FLETCHER, ROBERT.

1882. On prehistoric trephining and cranial amulets. *Contr. North Amer. Ethnol.*, vol. 5, 32 pp.

FORD, EDWARD.

1937. Trephining in Melanesia. *Med. Journ. Australia*, vol. 2, pp. 471-477.

GILLMAN, HENRY.

1876. Certain characteristics pertaining to ancient man in Michigan. *Ann. Rep. Smithsonian Inst. for 1875*, pp. 234-245.

1885. Further confirmation of the post-mortem character of the cranial perforations from Michigan mounds. *Amer. Nat.*, vol. 19, pp. 1127-1128.

GRAÑA, FRANCISCO; ROCCA, ESTEBAN D.; and GRAÑA R., LUIS.

1954. Las trepanaciones craneanas en el Perú en la época prehispánica. 340 pp. Lima.

GUIARD, ÉMILE.

1930. La trépanation cranienne chez les Néolithiques et chez les primitifs modernes. 126 pp., 13 pls. Paris.

HAMY, E. T. See SANSON.**HEYERDAHL, THOR.**

1952. *American Indians in the Pacific.* xv + 821 pp. London.

HINSDALE, W. B.

1924. An unusual trephined skull from Michigan. *Pap. Michigan Acad. Sci., Arts and Letters*, vol. 4, pt. 1, pp. 13-14.

HINSDALE, W. B., and GREENMAN, EMERSON F.

1936. Perforated Indian crania in Michigan. *Occ. Contr. Mus. Anthrop.*, Univ. Michigan, No. 5, 15 pp., 5 pls.

HRDLIČKA, A.

1939. Trepanation among prehistoric people, especially in America. *Ciba Symposia*, vol. 1, pp. 170-177, 200.

KIDD, G. E.

1930. A case of primitive trephining. *Museum and Art Notes (Vancouver)*, vol. 5, pp. 85-87.

LEECHMAN, DOUGLAS.

1944. Trephined skulls from British Columbia. *Trans. Roy. Soc. Canada, Sect. II*, pp. 99-102, 4 pls.

LESSON, A. See TOPINARD.**LUMHOLTZ, CARL, and HRDLIČKA, ALEŠ.**

1897. Trephining in Mexico. *Amer. Anthrop.*, o. s., vol. 10, pp. 389-396.

MACCURDY, GEORGE GRANT.

1905. Prehistoric surgery—a neolithic survival. *Amer. Anthrop.*, n. s., vol. 7, pp. 17-23.

1923. Human skeletal remains from the highlands of Peru. *Amer. Journ. Phys. Anthrop.*, vol. 6, No. 3, pp. 217-330, 49 pls.
- MALBOT, HENRI, and VERNEAU, R.
1897. Les Chaouias et la trépanation du crâne dans l'Aurès. *L'Anthrop.*, vol. 8, pp. 1-18, 174-204.
- MANOUVRIER, L.
1895. Curieuse mutilation crânienne néolithique. *Bull. Soc. Anthrop. Paris*, 4^e sér., vol. 6, pp. 357-360.
- MASON, OTIS T.
1885. The Chacacayo trephined skull. *Proc. U. S. Nat. Mus.*, vol. 8, pp. 410-412, 1 pl.
- McGEE W J See MUÑIZ and McGEE.
- MOODIE, ROY L.
1921. A variant of the sincipital T in Peru. *Amer. Journ. Phys. Anthrop.*, vol. 4, pp. 219-222, 2 pls.
1929. Studies in paleopathology, XXIII. Surgery in pre-Columbian Peru. *Ann. Med. Hist.*, n. s., vol. 1, pp. 698-728.
1930. Studies in paleopathology, XXIV. Prehistoric surgery in New Mexico. *Amer. Journ. Surg.*, n. s., vol. 8, pp. 905-908.
- MORALES MACEDO, CARLOS.
1917. La trepanación del cráneo y su representación en la cerámica peruana. *Proc. Sec. Pan Amer. Sci. Congr.*, Washington, Sect. I, *Anthrop.*, pp. 265-267.
- MUÑIZ, MANUEL ANTONIO, and McGEE, W J
1897. Primitive trephining in Peru. 16th *Ann. Rep. Bur. Amer. Ethnol.* for 1894-95, pp. 3-72.
- PARRY, WILSON.
1936. Three skulls from Palestine showing two types of primitive surgical holing; being the first skulls exhibiting this phenomenon that have been discovered on the mainland of Asia. *Man*, vol. 36, No. 234, p. 170.
- PIGGOTT, STUART.
1940. A trepanned skull of the Beaker Period from Dorset and the practice of trepanning in prehistoric Europe. *Proc. Prehist. Soc.*, n. s., vol. 6, No. 3, pp. 112-132.
- PRUNIÈRES (DE MAROEJOLS).
1874. Sur les crânes artificiellement perforés à l'époque des dolmens. *Bull. Soc. Anthrop. Paris*, 2^e sér., vol. 9, pp. 185-205.
- QUEVEDO A., SERGIO A.
1943. La trepanación incana en la región del Cuzco. *Rev. Univ. Cuzco*, año 32, No. 85, seg. sem., pp. 1-191. (Also separately, and in *Rev. Mus. Nac. Lima*, vol. 12, No. 1, pp. 8-13; No. 2, pp. 181-211; vol. 13, pp. 41-64, 153-192; vol. 14, pp. 82-123.)
- ROMERO, JAVIER.
1935. Cráneos trepanados de Monte Albán (unpublished MS.).
1952. Los patrones de la mutilación dentaria prehispánica. *Anales Inst. Nac. Antrop. e Hist.* for 1949-50, vol. 4, No. 32 de la colección, pp. 177-221, 19 pls., 2 folding figs. (See footnote 19, pp. 192-193. and pl. 8).
- SANSON, A.
1874. Sur les perforations artificielles du crâne chez les insulaires de la mer du Sud. *Bull. Soc. Anthrop. Paris*, 2^e sér., vol. 9, pp. 494-495.

SHAPIRO, H. L.

1927. Primitive surgery. First evidence of trephining in the Southwest. *Nat. Hist.*, vol. 27, pp. 266-269.

SMITH, HARLAN I.

1924. Trephined aboriginal skulls from British Columbia and Washington. *Amer. Journ. Phys. Anthrop.*, vol. 7, pp. 447-452.

SQUIER, E. GEORGE.

1877. Peru; Incidents of travel and exploration in the land of the Incas, p. 456; Appendix, p. 577. New York.

STARKEY, J. L.

1936. Discovery of skulls with surgical holing at Tell Duweir, Palestine. *Man*, vol. 36, No. 233, p. 169.

STEWART, T. D.

1940. Demonstration of an Indian skull from Maryland with a perforation suggesting trepanation. *Amer. Journ. Phys. Anthrop.*, vol. 27, No. 2, supplement, pp. 15-16.
1943. Skeletal remains from Paracas, Peru. *Amer. Journ. Phys. Anthrop.*, n. s., vol. 1, No. 1, pp. 47-63.
1950. Deformity, trephining, and mutilations in South American Indian skeletal remains. *Bur. Amer. Ethnol. Bull.* 143 (*Handbook of South American Indians*), vol. 6, pp. 43-48.
1956. Significance of osteitis in ancient Peruvian trephining. *Bull. Hist. Med.*, vol. 30, No. 4, pp. 293-320.

TELLO, JULIO C.

1913. Prehistoric trephining among the Yauyos of Peru. *Proc. 18th Internat. Congr. Amer. London (1912)*, pp. 75-83.

TOPINARD, PAUL.

1875. Des instruments de chirurgie de Taïti recueillis par M. A. Lesson. *Bull. Soc. Anthrop. Paris*, 2^e sér., vol. 10, pp. 619-621.

TURNER, GEORGE.

1884. Samoa a hundred years ago and before. London.

VÉLEZ LÓPEZ, LIZARDO.

1940. La cirugía del cráneo en los vasos del Perú precolombino. *Bol. Mus. Hist. Nat.*, Lima, año 4, No. 12, pp. 105-112.

VIDAL SENÈZE, PIERRE.

1877. Peforations crâniennes sur d'anciens crânes du haut Pérou. *Bull. Soc. Anthrop. Paris*, 2^e sér., vol. 12, pp. 561-563.

WAKEFIELD, E. G., and DELLINGER, S. C.

1936. The probable adaptation of utilitarian implements for surgical procedures by the "Mound Builders" of eastern Arkansas. *Journ. Bone and Joint Surg.*, vol. 18, pp. 434-438.
1939. Possible reasons for trephining the skull in the past. *Ciba Symposia*, vol. 1, No. 6, pp. 166-169.

WEISS, PEDRO.

1949. La cirugía del cráneo entre los Antiguos Peruanos. 34 pp. Lima.
1953. Las trepanaciones peruanas estudiadas como técnica en sus relaciones con la cultura. *Rev. Mus. Nac.*, Lima, vol. 22, pp. 17-34.
1955. Casos peruanos prehistoricos de cauterizaciones craneanas; T sincipital de Manouvrier. *Rev. Mus. Anthrop. y Arqueol.* Lima, vol. 2, pt. 2, 1^{er} sem., pp. 3-23, 8 pls.

WÖLFEL, D. J.

1925. Die Trepanation. *Anthropos*, vol. 20, pp. 1-50.

ZABOROWSKI.

1897. Le T sincipital. Mutilation des crânes neolithiques, observée en Asie Centrale. *Bull. Soc. Anthrop. Paris*, 4^e sér., vol. 8, pp. 501-503.

INDEX

A

- Abbot, C. G., x
 Accessions, 11, 64, 65, 83, 84, 85, 88, 98, 121, 126, 174, 185
 Bureau of American Ethnology, 64, 65
 Freer Gallery of Art, 98
 Library, 185
 National Air Museum, 121
 National Collection of Fine Arts, 83, 84, 85, 88
 National Gallery of Art, 174
 National Museum, 11
 National Zoological Park, 126
 Anderson, Clinton P., Regent of the Institution, v, 4
 Anglim, J. E., vi
 Aniline dyes—their impact on biology and medicine (Morris C. Leikind), 429
 Applegate, Shelton P., 25
 Appropriations, 5, 44, 147, 173, 203
 Arthur lecture, 6, 233
 Astrophysical Observatory (Fred L. Whipple, Director), vii, 5, 8, 68
 Appropriation, 5
 Astrophysical Research, Division of, 68
 Field station, vii
 Publications, 75, 80, 194
 Radiation and Organisms, Division of, vii, 77
 Report, 68
 Staff, vii
 Astrophysical Research, Division of, 68
 Publications, 75
 Report, 68

B

- Baerreis, David A., 55
 Bales, Richard, 183
 Bamboo in the economy of oriental peoples (F. A. McClure), 391
 Bartsch, Paul, ix
 Bass, William M., 48
 Bassler, R. S., ix
 Battison, Edwin A., vi, 29, 30, 38
 Bayer, Frederick M., vi
 Beall, Carlton G., 150
 Beggs, Thomas M., Director, National Collection of Fine Arts, vii, 82, 95, 97
 Belin, Ferdinand Lamot, Vice President, National Gallery of Art, viii, 172, 173
 Benn, James H., vi

- Benson, Elizabeth, 179
 Benson, Ezra Taft, Secretary of Agriculture, Member of the Institution, v
 Bio-Sciences Information Exchange, 7
 Bishop, Philip W., vii, 30, 38
 Blanchard, Ruth, 187
 Biiss, Robert Woods, 82, 83
 Bolli, Hans, 27
 Böving, Adam G., 39
 Bowman, T. E., vi, 23
 Bowsher, A. L., 26
 Boyle, W. E., vi
 Bredin, J. Bruce, ix
 Briggs, R. E., vii
 Brooks, Overton, Regent of the Institution, v, 4
 Brown, Mrs. G. E., 36
 Brown, John Nicholas, Regent of the Institution, v, 4, 82
 Brown, R. W., ix
 Brown, William L., vi, 33
 Brownell, Herbert, Jr., Attorney General of the United States, Member of the Institution, v
 Bruns, Franklin R., Jr., vii, 32
 Buchanan, L. L., ix
 Bureau of American Ethnology (Matthew W. Stirling, Director), vii, 5, 8, 40
 Accessions, 64, 65
 Appropriation, 5
 Archives, 62
 Collections, 65
 Editorial work and publications, 64, 194
 Illustrations, 64
 Miscellaneous, 66
 Report, 40
 River Basin Surveys, 44
 Staff, vii
 Systematic researches, 40

C

- Cairns, Huntington, Secretary-Treasurer and General Counsel, National Gallery of Art, viii, 172, 184
 Caldwell, Joseph R., 48
 Caldwell, Warren W., 48, 53, 58, 59
 Campbell, Leon, Jr., 73
 Campbell, William P., 172, 179
 Canal Zone Biological Area, viii, 5, 9, 155
 Acknowledgments, 162
 Appropriation, 5, 203
 Buildings, equipment, and improvements, 159

Canal Zone Biological Area—Continued
 Finances, 162
 Plans and urgent requirements, 160
 Rainfall, 153
 Report, 155
 Scientists, students, and observers, 155
 Visitors, 157
 Cannon, Clarence, Regent of the Institution, v, 4, 204
 Carmichael, Leonard, Secretary of the Institution, v, viii, 33, 34, 82, 83, 112
 Carriker, M. A., ix
 Cartwright, O. L., vi, 23
 Chace, Fenner A., Jr., vi
 Chamberlain, Joseph Miles (The development of the planetarium in the United States), 261
 Chancellor of the Institution (Earl Warren, Chief Justice of the United States), v, 4, 172
 Chase, Mrs. Agnes, ix
 Chief Justice of the United States (Earl Warren, Chancellor of the Institution), v, 4, 172
 Chilton, Mrs. Alexander, 35, 36
 Christensen, Erwin O., 179
 Clain-Stefanelli, Vladimir, vii, 33, 38
 Clark, Mrs. Leila F., librarian of the Institution, v, 183
 Clark, Robert Sterling, 38
 Clark, T. F., treasurer of the institution, v
 Clarke, Gilmore D., 82, 83
 Clarke, J. F. Gates, vi
 Cloud, Preston, ix
 Coale, George L., 48
 Coast and Geodetic Survey, United States, 1807-1957 (Elliott B. Roberts), 221
 Cochran, Doris M., vi
 Collins, Henry B., Jr., vii, 41, 42
 Compton, Arthur H., Regent of the Institution, v, 4
 Conger, Paul S., vi
 Cooke, C. Wythe, ix
 Cooke, Hereward Lester, 179
 Cooper, G. Arthur, vi, 26, 38
 Cosmic rays from the sun (Thomas Gold), 233
 Cott, Perry B., Chief Curator, National Gallery of Art, viii, 172, 179
 Cotton harvest, Mechanizing the (James H. Street), 413
 Cowan, Richard S., vi, 38
 Crabill, Ralph E., Jr., vi, 37
 Crist, Raymond E. (The land and people of the Guajira Peninsula), 339
 Cushman, Robert A., 35
 Cutress, Charles E., Jr., vi, 23

D

Dale, Chester, President, National Gallery of Art, viii, 172, 173
 Davis, Malcolm, 148, 150
 Deaton, Norman H., 33

DeGolyer, Everette Lee, Regent of the Institution, 4
 Deignan, H. G., vi
 Densmore, Frances, 66
 DePrato, Mario, 148
 Derrow, James M., 147
 Dieter, Mrs. Nannielou, 69
 Docent service, 35
 Doolittle, Lt. Gen. James H., viii, 112
 Dorman, C. G., vii
 Doyle, Maj. Gen. John P., 112
 Drake, C. J., ix
 Dulles, John Foster, Secretary of State, Member of the Institution, v, viii
 Dunbar, C. O., 26
 Dunkle, David H., vi, 25, 26
 Dutro, J. T., 26

E

Editorial and Publications Division (Paul H. Oehser, chief), v, 195
 Report, 189
 Eisenhower, Dwight D., President of the United States, Presiding Officer ex officio, v
 Elder, R. A., Jr., vi
 Elstad, Victor B., vii, 78
 Erickson, Ray, 150
 Establishment (Members of the Institution), v, 4
 Ettinghausen, Richard, viii, 106, 107, 108, 110
 Evans, Clifford, Jr., vi, 20, 21
 Ewers, J. C., planning officer, National Museum, vi
 Executive Committee of the Board of Regents, 4, 196, 204
 Members, v, 204
 Report, 196
 Appropriations, 203
 Assets, 198
 Audit, 203
 Cash balances, receipts and disbursements, 200
 Endowment funds, 196, 198
 Freer Gallery of Art, 198
 Smithsonian, 196
 Summary of, 198
 Gifts and grants, 201
 Investments, classification of, 198
 Unexpended funds and endowments, 199
 Exhibitions, 33, 91, 96, 177
 National Museum, 33
 Special, 96, 177
 Traveling, 91, 177
 Exhibits, 2, 33, 100, 114, 125
 Freer Gallery of Art, 100
 Modernization of, 2, 33
 National Air Museum, 114
 National Zoological Park, 125
 Exploration and fieldwork, 20, 40
 Bureau of American Ethnology, 40
 National Museum, 20
 River Basin Surveys, 45

F

- Fauntleroy, Travis, 148
 Feidler, Ernest R., Administrator, National Gallery of Art, viii, 172
 Field, W. D., vi
 Finances, 5
 Appropriations, 5, 44, 147, 173, 203
 Finley, David E., 82, 83
 Fireman, E. L., vii, 72, 76
 Fleming, Robert V., Regent of the Institution, v, 4, 5, 204
 Folsom, Marion B., Secretary of Health, Education, and Welfare, Member of the Institution, v
 Foshag, William F., 38
 Freer Gallery of Art (A. G. Wenley, Director), viii, 9, 98
 Attendance, 103
 Auditorium, 104
 Building, 102
 Collections, accessions, 98
 Repairs to, 100
 Exhibitions, changes in, 100
 Library, 101
 Publications, 102
 Report, 98
 Reproductions, 102
 Staff, viii
 Activities of, 104
 Friedmann, Herbert, vi, 22
 Froiland, A. G., vii
 Fyfe, Howard, 150

G

- Garber, Paul E., head curator, National Air Museum, viii, 124
 Gardner, Paul Vickers, vii, 82, 95
 Gazin, C. Lewis, vi, 24, 25
 Gazin, Mrs. Elisabeth H., 187
 Gettens, Rutherford J., viii, 104, 106, 107, 108, 109, 110
 Gifts, 88, 89, 112, 127, 160, 162, 174, 184, 201
 Canal Zone Biological Area, 160, 192
 National Air Museum, 112
 National Gallery of Art, 174, 184
 National Zoological Park, 127
 Glance, Grace E., vi
 Goins, Craddock R., vii
 Gold, Thomas, 6
 (Cosmic rays from the sun), 233
 Goodrich, Lloyd, 82
 Graf, J. E., Assistant Secretary of the Institution, v
 Graham, D. C., ix
 Graves, Mrs. Walter, 36
 Greeley, F. A., 69
 Greenewalt, Crawford H., Regent of the Institution, v, 4
 Grengo, Robert E., 48, 61
 Greenwood, Mrs. Arthur, ix, 33
 Griffenhagen, George B., vii, 5, 32
 Grimmer, J. Lear, viii, 147, 149
 Grosvenor, Melville Bell, 34

- Guajira Peninsula, The land and people of the (Raymond E. Crist), 339
 Guest, Grace Dunham, x

H

- Hafstad L. R. (Science, technology, and society), 207
 Hale, Mason E., Jr., vi, 38
 Handley, Charles O., Jr., vi, 22
 Harrington, John P., ix, 66
 Hartle, Donald D., 55, 59
 Haskins, Caryl P., Regent of the Institution, v, 4, 204
 Hawkins, Gerald S. (The development of radio astronomy), 279
 Hayes, Bartlett H., 82
 Heizer, R. F., ix
 Henbest, L. G., 26
 Henderson, E. P., vi, 71
 Henize, Karl G., 73, 76
 Herber, Elmer C., ix
 Herman, Carlton, 149
 Hilger, Sister M. Inez, ix
 Hindle, Brooke, 38
 Hobbs, Horton H., Jr., ix
 Hood, Maj. Gen. Reuben C., Jr., viii, 112
 Howard, James H., 48, 61
 Howell, A. B., ix
 Howell, Edgar M., vii, 33, 38
 Humphrey, George M., Secretary of the Treasury, Member of the Institution, v, viii
 Hunsaker, Jerome C., Regent of the Institution, v, 4
 Huscher, Harold A., 52, 53, 59
 Hynek, J. Allen, 73, 76

I

- International Exchange Service (D. G. Williams, chief), viii, 5, 9, 163
 Appropriation, 5
 Foreign depositories of governmental documents, 164
 Foreign exchange services, 170
 Interparliamentary exchange of the official journal, 167
 Packages received and sent, 163
 Report, 163
 Irving, William N., 53, 59

J

- Jacchia, Luigi G., vii, 72
 Jacks, G. V. (The influence of man on soil fertility), 325
 Jackson, Hartley H. T. (The return of the vanishing musk oxen), 381
 James, Macgill, Assistant Director, National Gallery of Art, viii, 172
 Jellison, W. L., ix
 Jet streams (R. Lee), 293
 Johnson, Alfred E., 59
 Johnson, David H., vi, 22
 Jones, Mrs. L. Frances, 187
 Judd, N. M., ix

K

- Kainen, Jacob, vii, 30
 Kauffmann, Henrik, 113
 Kaunitz, Hans (Causes and consequences of salt consumption), 445
 Keddy, J. L., Assistant Secretary of the Institution, v
 Kellogg, A. Remington, Director, National Museum, vi, 34, 39
 Kendall, Edward C., vii, 31
 Kestner, F. B., chief, photographic laboratory, v
 Kier, P. M., vi
 Killip, E. P., ix
 King, W. James, vii, 29, 30
 Klaphor, Mrs. Margaret W. Brown, vii
 Klein, W. H., vii, 78, 81
 Knight, J. B., ix
 Koford, Carl B., viii, 162
 Koford, Mrs. C. B., 161
 Kress, Rush H., viii, 172
 Krieger, H. W., vi
 Krook, Max, vii, 69

L

- Lachner, Ernest A., vi, 22, 23
 Lamont, Mrs. Edward, 36
 Lang, Andrew, 71
 Lautman, Don, 73
 Lectures, 6, 104, 181
 Archaeological Institute of America
 (George E. Mylonas), 6
 Arthur (Thomas Gold), 6, 233
 Freer Gallery of Art, 7, 104
 National Gallery of Art, 7, 181
 Lee, R. (Jet streams), 293
 Leikind, Morris C. (Aniline dyes—their impact on biology and medicine), 429
 Leonard, E. C., vi
 Leopold, Estella B. (Pollen and spores and their use in geology), 303
 Lewis, G. E., 26
 Lewton, F. L., ix
 Library (Mrs. Leila F. Clark, librarian), v, 9, 101, 120, 182, 185
 Freer Gallery of Art, 101
 National Air Museum, 120
 National Gallery of Art, 182
 Smithsonian, 9, 185
 Accessions, 185
 Report, 185
 Statistics, 188
 Lindsay, G. C., vi
 Loeblich, A. R., Jr., 27, 37
 Loeblich, Mrs. Helen N., ix
 Loehr, Max, x
 Loening, Grover, viii, 112
 Lowe, Frank O., 125
 Lyon, Rowland, 95

M

- Macdonald, Mrs. Peter, 36
 Mack, Peter, 114
 MacKay, F. W., ix

- Male, W. M., viii
 Manfuso, Mrs. John, 36
 Mann, William M., ix, 3, 125
 Manship, Paul, 82, 83
 Martin, Glenn J., 96
 Matalas, Nicholas, 71
 McCall, F. J., vii
 McClure, F. A., ix
 (Bamboo in the economy of oriental peoples), 391
 McClure, Mrs. William, 36
 McCormick, Mrs. Robert, 36
 McIntosh, Allen, ix
 McKern, T. W., ix
 McNutt, Charles H., 56, 59
 Meggers, Betty J., ix, 20, 21
 Mellon, Paul, viii, 172, 173
 Meltzer, Alan S., vii, 70
 Members of the Institution, v, 4
 Meteors (Fred L. Whipple), 239
 Miller, Carl, 44, 48, 49, 54
 Mitchell, James P., Secretary of Labor, Member of the Institution, v
 Moh, C. C., vii, 80
 Mongan, Elizabeth, 179
 Moore, Bruce, 113
 Moore, J. P., ix
 Morrison, J. P. E., vi
 Morton, Conrad V., vi, 22
 Muesebeck, C. F. W., ix
 Multhauf, Robert P., vi, vii, 27, 34, 38
 Murray, Mrs. Anne W., vii, 38
 Museum of History and Technology, 5, 36
 Appropriation, 5
 Musk oxen, The return of the vanishing (Hartley H. T. Jackson), 381
 Musteric, Joseph, 161
 Myers, George Hewitt, 83
 Mylonas, George E., 6

N

- National Air Museum, viii, 5, 9, 111
 Accessions, 121
 Advisory Board, viii, 111
 Appropriation, 5
 Assistance to Government departments, 117
 Exhibits, improvements in, 114
 Public information service, 118
 Reference material, 120
 Report, 111
 Special events and displays, 113
 Stephenson bequest, 113
 Stored aircraft, restoration of, 116
 National Collection of Fine Arts (Thomas M. Beggs, Director), vii, 5, 8, 82
 Accessions, 83, 84, 85, 88
 Appropriation, 5
 Art works lent, 85
 Barney, Alice Pike, fund, 89
 Information service, 94
 Loans returned, 88
 Myer, Catherine Walden, fund, 85
 Publications, 94, 194
 Ranger, Henry Ward, fund, 90

- National Collection of Fine Arts—Con.
 Report, 82
 Smithsonian Art Commission, 82
 Smithsonian lending collection, 88
 Smithsonian Traveling Exhibition Service, vii, 91
 Special exhibitions, 96
 Staff activities, 94
 Withdrawals by owners, 85
- National Gallery of Art, viii, 6, 9, 172
 Accessions, 174
 Activities, 179, 183
 Appropriation, 173
 Attendance, 6, 173
 Audit of private funds, 184
 Buildings and grounds, maintenance of, 182
 Educational program, 180
 Exhibitions, special, 177
 Traveling, 177
 Gifts, 174, 184
 Index of American Design, 182
 Library, 182
 Officials, viii, 172
 Organization, 172
 Personnel, 173
 Publications, 180
 Report, 172
 Restoration, 179
 Trustees, viii, 172
 Works of art, lent, 176
 On loan, 175
 Returned, 176
- National Museum (A. Remington Kellogg, Director), vi, 5, 7, 11
 Appropriation, 5
 Buildings and equipment, 36
 Collections, 11
 Exhibitions, 33
 Exploration, fieldwork, and related travel, 20
 Organization and staff, 37
 Report, 11
 Staff, v
 Visitors, 36
- National Zoological Park (Theodore H. Reed, Acting Director), viii, 5, 6, 9, 125
 Accessions, 126
 Animals in the collection on June 30, 1957, 131
 Appropriation, 5, 147, 203
 Births and hatchings, 129
 Cooperation, 150
 Exchanges, 128
 Exhibits, 125
 Finances, 147
 Gifts, 127
 Information and education, 148
 Personnel, 147
 Plans for the future, 153
 Purchases, 128
 Report, 125
 Status of the collection, 130
 Veterinarian's report, 148
 Visitors, 6, 151
- Nelson, Mrs. Robert, 35, 36
 Neuman, Robert W., 52, 53, 60
 Newman, J. B., chief, personnel division, v
 Newman, Marshal T., vi, 21
 Newville, Leslie J., 30
 Nicol, David, vi, 26
 Nixon, Richard M., Vice President of the United States, member of the Institution, v, 4
 Norris, Ralph, 148
- O
- Oehser, Paul H., chief, editorial and publications division, v, 195
 Officials of the Institution, v
 Oliver, L. L., superintendent of buildings and grounds, v
 Oliver, Smith H., 37
 Olsen, R., 71
 O'Neil, R., 71
 Orr, Douglas, 82
 Ott, John E., 26
- P
- Pancoast, John E., 172, 179
 Parfin, Sophy, vi
 Pearce, Franklin L., 24, 26
 Pearson, Mrs. Louise M., administrative assistant to the Secretary, v
 Perry, Kenneth M., vii, 30
 Perry, Stuart Hoffman, 38
 Personnel division (J. B. Newman, chief), v
 Peterson, Mendel L., vii, 32, 38
 Phillips, Duncan, viii, 172, 173
 Photographic laboratory (F. B. Kestner, chief), v
 Planetarium, The development of the, in the United States (Joseph Miles Chamberlain), 261
 Pollen and spores and their use in geology (Estella B. Leopold and Richard A. Scott), 303
 Pope, Mrs. Annemarie H., chief, Smithsonian Traveling Exhibition Service, vii, 95
 Pope, John A., Assistant Director, Freer Gallery of Art, viii, 105, 106, 109
 Powell, Mrs. Bolling, 36
 President of the United States (Dwight D. Eisenhower, Presiding Officer ex officio of the Institution), v
 Presiding Officer ex officio (Dwight D. Eisenhower, President of the United States), v
 Price, Derek J., 27, 28, 38
 Price, Leonard, vii, 79
 Publications, 10, 64, 75, 80, 94, 102, 180, 189.
 American Historical Association, 195

Publications—Continued

- Astrophysical Observatory, 75, 80, 194
 Bureau of American Ethnology, 64, 194
 Daughters of the American Revolution, 195
 Distribution, 189
 Freer Gallery of Art, 102
 National Collection of Fine Arts, 94, 194
 National Gallery of Art, 180
 National Museum, 192
 Report, 189
 Smithsonian, 190

Q

Quigley, Carroll, ix

R

- Radiation and Organisms, Division of vii, 77
 Publications, 80
 Report, 77
 Staff, vii
- Radio astronomy, The development of (Gerald S. Hawkins), 279
- Ray, David, 186
- Red tide, Mystery of the (F. G. Walton Smith), 371
- Reed, Theodore H., Acting Director, National Zoological Park, viii, 4, 154
- Reeside, J. B., Jr., ix
- Reeves, Mrs. Jay B. L., 36
- Regents, Board of, v, 4, 196
 Annual meeting, 5
 Executive Committee, v, 4, 204
 Members, v, 204
 Report, 196
 Members, v, 4
- Rehder, Harald A., vi, 23
- Research associates, collaborators, and fellows, ix
- Rhoades, Katherine N., x
- Riesenberg, Saul H., vi, 37
- Riggs, F. Behn, Jr., vii, 71
- Rinehart, J. S., Assistant Director, Astrophysical Observatory, vii, 70, 71, 76
- River Basin Surveys, v, 5, 44
 Appropriation, 5, 44
 Cooperating institutions, 62
 Fieldwork, 45
 Alabama, 49
 Arkansas, 49
 Georgia, 49
 Iowa, 50
 Kansas, 50
 Missouri Basin, 51
 Snake River Basin, 61
 Report, 44
 Washington office, 48
- Roberts, Elliott B. (United States Coast and Geodetic Survey, 1807-1957), 221

- Roberts, Frank H. H., Jr., Associate Director, Bureau of American Ethnology and Director, River Basin Surveys, vii, 40, 41, 44, 48
 Rogers, Grace L., vii, 31
 Roth, Rodris C., vi
 Rudd, Velva E., vi
 Ruhoff, Theodore B., 24, 25
 Runnestrand, Paul, 162
 Russell, Rear Adm. James S., viii, 112

S

- Salt consumption, Causes and consequences of (Hans Kaunitz), 445
- Saltonstall, Leverett, Regent of the Institution, v, 4
- Sarcophagi, Roman garland, from the quarries of Proconnesus (Marmara) (J. B. Ward Perkins), 455
- Sawyer, Charles H., 82
- Schaller, W. T., ix
- Schmitt, Waldo L., vi, 4, 23, 37
- Schoenfeld, Mrs. John, 36
- Schultz, Leonard P., vi
- Schwartz, Benjamin, ix
- Schwartz, Raymond A., viii
- Science, technology, and society (L. R. Hafstad), 207
- Scott, Richard A. (Pollen and spores and their use in geology), 303
- Searle, Mrs. Harriet Richardson, ix
- Seaton, Fred A., Secretary of the Interior, Member of the Institution, v
- Secretary of the Institution (Leonard Carmichael), v, 172, 173
- Secretary of State (John Foster Dulles), v, viii, 172
- Secretary of the Treasury (George M. Humphrey), v, viii, 172, 173
- Setzer, Henry W., vi, 34
- Setzler, Frank M., vi, 20, 35
- Shapley, Mrs. Fern R., 172
- Shepard, Katherine, 179
- Shoemaker, C. R., ix
- Shropshire, Walter, 78, 79, 81
- Sigiura, Atsushi, 100
- Sinton, William M., 70
- Sirlouis, J. R., vii
- Skinner, John, 26
- Skull surgery, Stone Age: A general review, with emphasis on the New World (T. D. Stewart), 469
- Sladen, William, 149
- Smith, A. C., 37
- Smith, F. G. Walton (Mystery of the red tide), 371
- Smith, G. Hubert, 53, 59, 60, 61
- Smith, H. Alexander, Regent of the Institution, v, 4
- Smith, Lyman B., 22, 38
- Smithsonian Art Commission, 82
- Smithsonian Traveling Exhibition Service, vii, 91
- Snodgrass, R. E., ix
- Sohns, Ernest R., 37
- Soil fertility, The influence of man on (G. V. Jacks), 325

- Solecki, Ralph S., ix, 66
 Soper, C. C., x
 Squier, R. J., ix
 Staff, v, 37
 National Museum, vi, 37
 Stanley, Wendell M. (The nature of viruses, cancer, genes, and life—A declaration of dependence), 357
 Stephenson, Robert L., 51, 54, 56, 58
 Stern, Harold, P., viii, 106, 107, 108
 Sterne, Theodore E., vii, 69, 74
 Stevenson, J. A., ix
 Stewart, T. Dale, vi, 20, 37
 (Stone Age skull surgery: A general review, with emphasis on the New World), 469
 Stirling, Mrs. E. T., 36
 Stirling, Matthew W., Director, Bureau of American Ethnology, vii, 40, 67
 Stirling, Mrs. Matthew W., 40
 Stout, William B., 112
 Straub, P. A., ix
 Street, James H. (Mechanizing the cotton harvest), 413
 Sturtevant, W. C., vii, 42, 43, 44
 Sugiura, T., 100
 Sullivan, Francis, 179
 Summerfield, Arthur E., Postmaster General of the United States, Member of the Institution, v
 Superintendent of buildings and grounds (L. L. Oliver), v
 Supply division (A. W. Wilding, chief), v
 Swallen, Jason R., vi
 Swanton, John R., ix, 66
 Switzer, George S., vi
- T
- Taylor, Frank A., Assistant Director, National Museum, vi, 28
 Taylor, William R., vi, 37
 Taylor, W. W., Jr., ix
 Tobin, W. J., ix
 Traveling Exhibition Service. (See Smithsonian Traveling Exhibition Service)
 Treasurer of the Institution (T. F. Clark), v
- U
- United States Coast and Geodetic Survey, 1807-1957 (Elliott B. Roberts), 221
 Usilton, Mrs. Bertha M., 109
- V
- Vice President of the United States (Richard M. Nixon, Member of the Institution), 4
 Viruses, cancer, genes, and life, The nature of—A declaration of dependence (Wendell M. Stanley), 357
 Visitors, 6, 36, 103, 151, 157, 174
 Canal Zone Biological Area, 157
 Freer Gallery of Art, 103
 National Gallery of Art, 173
 Visitors—Continued
 National Museum, 36
 National Zoological Park, 151
 Vorys, John M., Regent of the Institution v, 4
- W
- Waddell, John H., 70
 Walker, Egbert H., vi
 Walker, Ernest P., ix, 125
 Walker, John, Director, National Gallery of Art, viii, 172, 173
 Wallis, Mrs. Richard, 36
 Ward Perkins, J. B. (Roman garland sarcophagi from the quarries of Proconnesus (Marmara)), 455
 Waring, A. J., Jr., ix, 66
 Warren, Earl, Chief Justice of the United States, Chancellor of the Institution, v, viii, 4
 Watkins, C. Malcolm, vi, 21
 Watkins, William N., vii
 Wedderburn, A. J., Jr., vii
 Wedel, Waldo R., vi, 21, 54, 55
 Weeks, Sinclair, Secretary of Commerce, Member of the Institution, v
 Wegenroth, Stow, 82
 Weiss, Helena M., vi
 Wenley, Archibald G., Director, Freer Gallery of Art, viii, 82, 107, 108, 109, 110
 West, Elisabeth, 107
 West, Mrs. Lnor O., 109
 Wetmore, Alexander, ix, 23, 24
 Wheeler, Richard P., 61
 Whipple, Fred L., Director, Astrophysical Observatory, vii, 77, 81
 (Meteors), 239
 White, Lawrence Grant, 82
 White, P. Alton, 162
 White, Theodore E., 56
 Whitney, Charles A., vii, 69
 Wilding, A. W., chief, supply division, v
 Williams, D. G., chief, International Exchange Service, viii, 171
 Williams, Woodbridge, 40
 Wilmeth, Roscoe, 55
 Wilson, Charles E., Secretary of Defense, Member of the Institution, v
 Wilson, Mrs. Mildred S., ix
 Withrow, Mrs. Alice P., vii, 79
 Withrow, R. B., vii, 77, 78, 80, 81
 Wolf, J. B., vii, 79
 Woodbury, Robert S., vi, vii, 28, 29, 30, 38
 Woolworth, Alan R., 55
 Wyeth, Andrew, 82
 Wyeth, Mrs. George, 36
- Y
- Young, Mahonri, 82
- Z
- Zähringer, J., 72
 Zetek, James, x, 160
 Zoological Park (See National Zoological Park)



SMITHSONIAN INSTITUTION LIBRARIES



3 9088 00947 9577